

TABLE OF CONTENTS

1	QUICK GUIDE	11
2	AUDIO SYSTEM	23
3	Bluetooth® HANDS-FREE SYSTEM	75
4	SPEECH COMMAND SYSTEM	109
5	VEHICLE INFORMATION	113
6	SETUP	117
7	REAR VIEW MONITOR SYSTEM	153
8	NAVIGATION SYSTEM	167
9	APPLICATION	231
	INDEX	261

Introduction

■ EXISTENCE OF NAVIGATION CAPABILITIES

Existence of navigation capabilities can be confirmed by performing the following method:

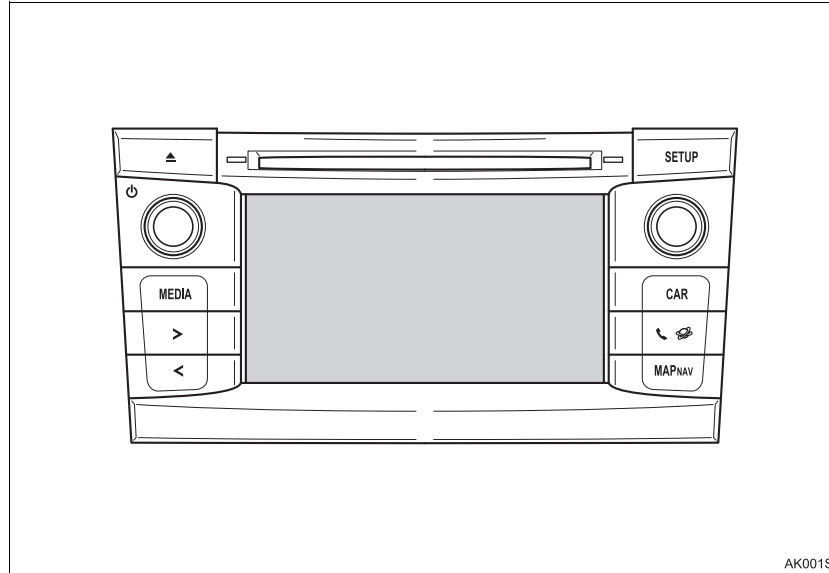

▶ Vehicles without smart entry & start system

1 When the engine switch is turned to the “ACC” or “ON” position, the initial screen will be displayed and the system will begin operating.

▶ Vehicles with smart entry & start system

1 When the engine switch is turned to the ACCESSORY or IGNITION ON mode, the initial screen will be displayed and the system will begin operating.

2 Press the “MAP/NAV” button.

- Either of the following screens will be displayed.

▶ Multimedia system

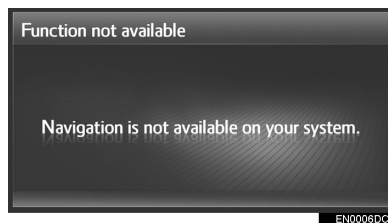

▶ Navigation system



SYMBOLS USED IN ILLUSTRATIONS



Safety symbol

The symbol of a circle with a slash through it means “Do not”, “Do not do this”, or “Do not let this happen”.

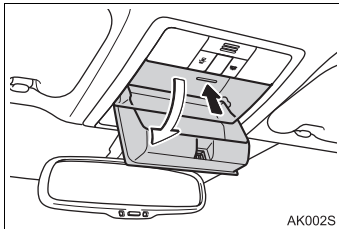

Arrows indicating operations

➔ Indicates the action (pushing, turning, etc.) used to operate switches and other devices.

⇨ Indicates the outcome of an operation (e.g. a lid opens).

HOW TO READ THIS MANUAL

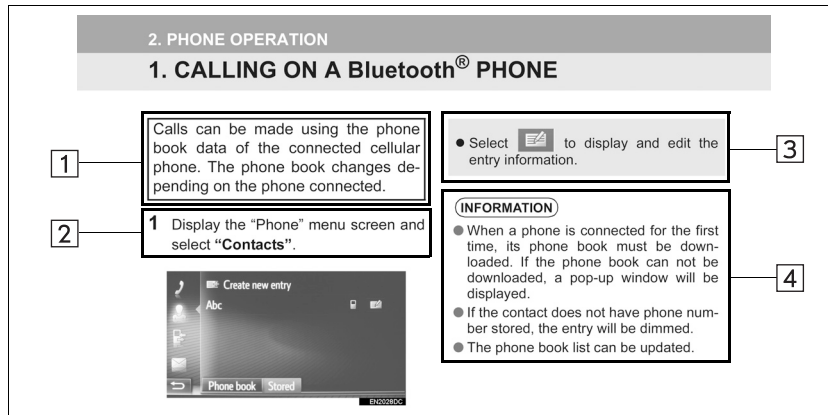

No.	Name	Description
1	Operational Outlines	An outline of the operation is explained.
2	Main Operations	The steps of an operation are explained.
3	Related Operations	A main operation's supplementary operations are described.
4	Information	Useful information for the user is described.

NAVIGATION SYSTEM OWNER'S MANUAL

This manual explains the operation of the navigation/multimedia system. Please read this manual carefully to ensure proper use. Keep this manual in your vehicle at all times.

The screen shots in this document and the actual screens of the navigation/multimedia system differ depending on whether the functions and/or a contract existed and the map data available at the time of producing this document.

Please be aware that the content of this manual may be different from the navigation/multimedia system in some cases, such as when the system's software is updated.

NAVIGATION SYSTEM

The Navigation System is one of the most technologically advanced vehicle accessories ever developed. The system receives satellite signals from the Global Positioning System (GPS) operated by the U.S. Department of Defense. Using these signals and other vehicle sensors, the system indicates your present position and assists in locating a desired destination.

The navigation system is designed to select efficient routes from your present starting location to your destination. The system is also designed to direct you to a destination that is unfamiliar to you in an efficient manner. The system is developed by "Harman International" using "NAVTEQ" maps. The calculated routes may not be the shortest nor the least traffic congested. Your own personal local knowledge or "short cut" may at times be faster than the calculated routes.

The navigation system's database includes Point of Interest categories to allow you to easily select destinations such as restaurants and hotels. If a destination is not in the database, you can enter the street address or a major intersection close to it and the system will guide you there.

The system will provide both a visual map and audio instructions. The audio instructions will announce the distance remaining and the direction to turn in approaching an intersection. These voice instructions will help you keep your eyes on the road and are timed to provide enough time to allow you to maneuver, change lanes or slow down.

Please be aware that all current vehicle navigation systems have certain limitations that may affect their ability to perform properly. The accuracy of the vehicle's position depends on the satellite condition, road configuration, vehicle condition or other circumstances. For more information on the limitations of the system, refer to page 228.

TOYOTA MOTOR CORPORATION

IMPORTANT INFORMATION ABOUT THIS MANUAL

For safety reasons, this manual indicates items requiring particular attention with the following marks.

CAUTION

- This is a warning against anything which may cause injury to people if the warning is ignored. You are informed about what you must or must not do in order to reduce the risk of injury to yourself and others.

NOTICE

- This is a warning against anything which may cause damage to the vehicle or its equipment if the warning is ignored. You are informed about what you must or must not do in order to avoid or reduce the risk of damage to your vehicle and its equipment.

SAFETY INSTRUCTION (MULTIMEDIA SYSTEM)

To use this system in the safest possible manner, follow all the safety tips shown below.

Do not use any feature of this system to the extent it becomes a distraction and prevents safe driving. The first priority while driving should always be the safe operation of the vehicle. While driving, be sure to observe all traffic regulations.

Prior to the actual use of this system, learn how to use it and become thoroughly familiar with it. Read the entire Navigation system Owner's manual to make sure you understand the system. Do not allow other people to use this system until they have read and understood the instructions in this manual.

For your safety, some functions may become inoperable when driving. Unavailable screen buttons are dimmed.

CAUTION

- For safety, the driver should not operate the multimedia system while he/she is driving. Insufficient attention to the road and traffic may cause an accident.

SAFETY INSTRUCTION (NAVIGATION SYSTEM)



To use this system in the safest possible manner, follow all the safety tips shown below.

This system is intended to assist in reaching the destination and, if used properly, can do so. The driver is solely responsible for the safe operation of your vehicle and the safety of your passengers.

Do not use any feature of this system to the extent it becomes a distraction and prevents safe driving. The first priority while driving should always be the safe operation of the vehicle. While driving, be sure to observe all traffic regulations.

Prior to the actual use of this system, learn how to use it and become thoroughly familiar with it. Read the entire Navigation system Owner's manual to make sure you understand the system. Do not allow other people to use this system until they have read and understood the instructions in this manual.

For your safety, some functions may become inoperable when driving. Unavailable screen buttons are dimmed.

 CAUTION
<ul style="list-style-type: none">● For safety, the driver should not operate the navigation system while he/she is driving. Insufficient attention to the road and traffic may cause an accident.● While driving, be sure to obey the traffic regulations and maintain awareness of the road conditions. If a traffic sign on the road has been changed, route guidance may not have the updated information such as the direction of a one way street.

While driving, listen to the voice instructions as much as possible and glance at the screen briefly and only when it is safe. However, do not totally rely on voice guidance. Use it just for reference. If the system cannot determine the current vehicle position correctly, there is a possibility of incorrect, late, or non-voice guidance.

The data in the system may occasionally be incomplete. Road conditions, including driving restrictions (no left turns, street closures, etc.) frequently change. Therefore, before following any instruction from the system, look to see whether the instruction can be done safely and legally.

This system cannot warn about such things as the safety of an area, condition of streets, and availability of emergency services. If unsure about the safety of an area, do not drive into it. Under no circumstances is this system a substitute for the driver's personal judgement.

Use this system only in locations where it is legal to do so.

TABLE OF CONTENTS

<table border="1" style="width: 100%; border-collapse: collapse;"> <tr> <td style="text-align: center; width: 20px;">1</td> <td>QUICK GUIDE</td> </tr> </table> <p>1. QUICK GUIDE 12 SYSTEM FUNCTION INDEX 12</p> <p>2. CONTROLS AND FEATURES 14 OVERVIEW BUTTONS 14 TOUCH SCREEN GESTURES 16 TOUCH SCREEN OPERATION 17</p> <table border="1" style="width: 100%; border-collapse: collapse;"> <tr> <td style="text-align: center; width: 20px;">2</td> <td>AUDIO SYSTEM</td> </tr> </table> <p>1. BASIC OPERATION 24 QUICK REFERENCE 24 SOME BASICS 25</p> <p>2. RADIO OPERATION 28 AM/FM/DAB RADIO 28</p> <p>3. MEDIA OPERATION 36 CD 36 USB MEMORY 41 iPod 47 AUX 53 Bluetooth® AUDIO 56</p> <p>4. AUDIO REMOTE CONTROLS 63 STEERING SWITCHES 63</p> <p>5. TIPS FOR OPERATING THE AUDIO SYSTEM 65 OPERATING INFORMATION 65</p>	1	QUICK GUIDE	2	AUDIO SYSTEM	<table border="1" style="width: 100%; border-collapse: collapse;"> <tr> <td style="text-align: center; width: 20px;">3</td> <td>Bluetooth® HANDS-FREE SYSTEM</td> </tr> </table> <p>1. BASIC INFORMATION BEFORE OPERATION 76 QUICK REFERENCE 76 HANDS-FREE SYSTEM 79 REGISTERING AN ENTRY 83</p> <p>2. PHONE OPERATION 87 CALLING ON A Bluetooth® PHONE 87 RECEIVING CALLS ON A Bluetooth® PHONE 92 TALKING ON A Bluetooth® PHONE 93</p> <p>3. SHORT MESSAGE FUNCTION 97 SHORT MESSAGE FUNCTION 97</p> <p>4. WHAT TO DO IF... 102 TROUBLESHOOTING 102</p> <table border="1" style="width: 100%; border-collapse: collapse;"> <tr> <td style="text-align: center; width: 20px;">4</td> <td>SPEECH COMMAND SYSTEM</td> </tr> </table> <p>1. SPEECH COMMAND SYSTEM OPERATION 110 SPEECH COMMAND SYSTEM 110</p> <table border="1" style="width: 100%; border-collapse: collapse;"> <tr> <td style="text-align: center; width: 20px;">5</td> <td>VEHICLE INFORMATION</td> </tr> </table> <p>1. VEHICLE INFORMATION 114 QUICK REFERENCE 114 FUEL CONSUMPTION 115</p>	3	Bluetooth® HANDS-FREE SYSTEM	4	SPEECH COMMAND SYSTEM	5	VEHICLE INFORMATION
1	QUICK GUIDE										
2	AUDIO SYSTEM										
3	Bluetooth® HANDS-FREE SYSTEM										
4	SPEECH COMMAND SYSTEM										
5	VEHICLE INFORMATION										

6 **SETUP**

1. SETUP OPERATION 118
QUICK REFERENCE 118
GENERAL SETTINGS 120
DISPLAY SETTINGS 123
Bluetooth® SETTINGS 125
CONNECTIVITY SETTINGS 132
TELEPHONE SETTINGS 148
AUDIO SETTINGS 149
VEHICLE SETTINGS 151

7 **REAR VIEW MONITOR SYSTEM**

1. REAR VIEW MONITOR SYSTEM 154
REAR VIEW MONITOR SYSTEM 154
REAR VIEW MONITOR SYSTEM PRECAUTIONS 158
THINGS YOU SHOULD KNOW 164

8 **NAVIGATION SYSTEM**

1. BASIC INFORMATION BEFORE OPERATION 168
QUICK REFERENCE 168
DISPLAYING THE NAVIGATION SCREEN 173
NAVIGATION SYSTEM FUNCTION INDEX 175

2. MAP SCREEN OPERATION AND MAP ICONS 177
MAP SCREEN OPERATION 177
MAP ICONS 180

3. DESTINATION SEARCH 188
DESTINATION SEARCH INDEX 188
SEARCH OPERATION 189

4. ROUTE GUIDANCE 196
STARTING ROUTE GUIDANCE 196
ROUTE GUIDANCE 199
SETTING AND DELETING THE ROUTE 202

5. MY DESTINATIONS 210
REGISTERING AN ENTRY 210
DISPLAYING AND EDITING THE ENTRY INFORMATION 216
SENDING AND RESTORING STORED CONTACTS USING A USB MEMORY 219

6. NAVIGATION SETTING 221
MAP SETTINGS 221
ROUTE SETTINGS 224
TRAFFIC MESSAGE SETTINGS 225

7. NAVIGATION SYSTEM INFORMATION 228
LIMITATIONS OF THE NAVIGATION SYSTEM 228
NAVIGATION DATABASE UPDATES 230



TABLE OF CONTENTS

9 APPLICATION

1. APPLICATIONS OPERATION 232
QUICK REFERENCE 232
PICTURE SLIDESHOW 235
E-MAIL 237
CALENDAR 239
MirrorLink™ 241
TOYOTA EUROCARE 242

2. CONNECTED SERVICE 244
CONNECTED SERVICE
OVERVIEW 244
BEFORE USING CONNECTED
SERVICE 248
ONLINE SEARCH 251
Street View 256
Panoramio 257
LOADING POIs*/ROUTE 258
OPERATING AN APPLICATION
USING CONNECTED SERVICE 259

INDEX

ALPHABETICAL INDEX 262

*: Point of Interest

1

QUICK GUIDE

1 QUICK GUIDE

1. SYSTEM FUNCTION INDEX..... 12

2 CONTROLS AND FEATURES

1. OVERVIEW BUTTONS 14

2. TOUCH SCREEN GESTURES..... 16

3. TOUCH SCREEN OPERATION 17

ENTERING SCREEN OPERATION..... 18

LIST SCREEN OPERATION..... 19

1
2
3
4
5
6
7
8
9

1. QUICK GUIDE



1. SYSTEM FUNCTION INDEX

AUDIO SYSTEM

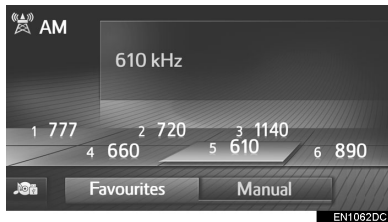
To access the audio system, press the “**MEDIA**” button. The audio control screen will be displayed. (→P.23)



Bluetooth® HANDS-FREE SYSTEM

To access the Bluetooth® hands-free system, press the  button. Each time the  button is pressed, the screen will change between the “Phone” menu screen and the “Extras”/“Toyota online” menu screen. The driver can make or receive phone calls without taking their hands off the steering wheel. (→P.75)

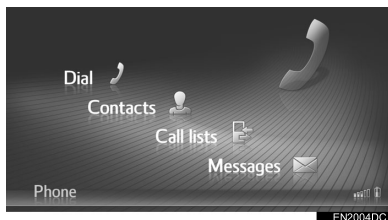

SPEECH COMMAND SYSTEM

To access the speech command system, press the  switch on the steering wheel. The driver can operate the system by giving a command. (→P.109)



VEHICLE INFORMATION

To access the vehicle information system, press the “**CAR**” button. Fuel consumption can be checked. (→P.113)

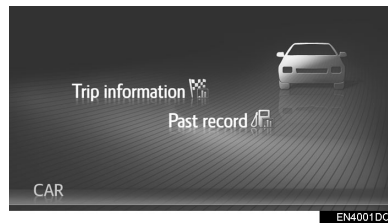

SETUP

To customise the function settings, press the “**SETUP**” button. (→P.117)

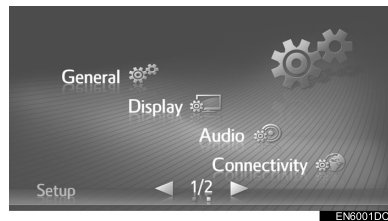

REAR VIEW MONITOR SYSTEM

Shifting into the “R” position will automatically show the view behind the rear of the vehicle on the display screen. (→P.153)



EN0009DC





NAVIGATION SYSTEM

To access the navigation system, press the “MAP/NAV” button. Each time the “MAP/NAV” button is pressed, the screen will change between the map screen and “Navigation” menu screen. (→P.167)



EN7005DC

APPLICATION SYSTEM

To access the application system, press the   button. Each time the   button is pressed, the screen will change between the “Phone” menu screen and the “Extras”/“Toyota online” menu screen. The driver can use applications. (→P.231)

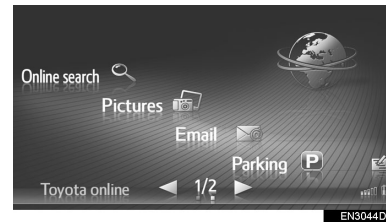

EN3044DC

2. CONTROLS AND FEATURES

1. OVERVIEW BUTTONS

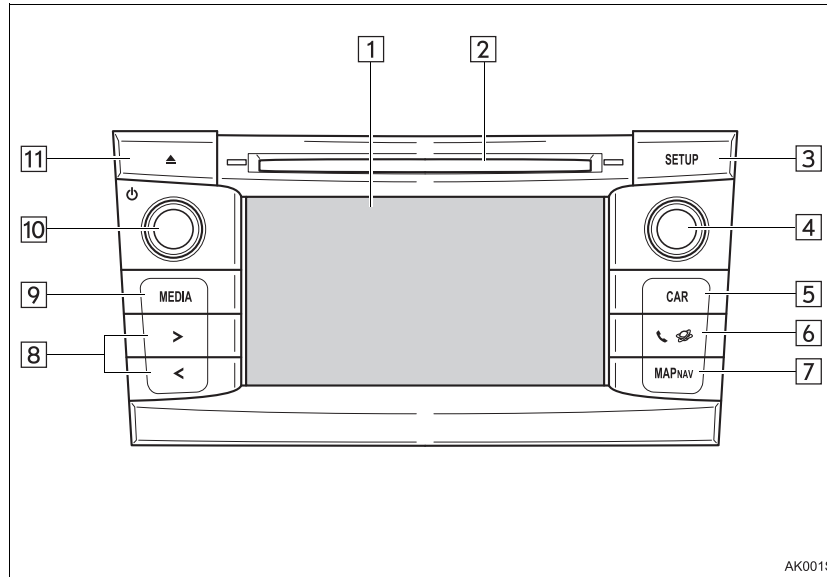

No.	Function	Page
1	By touching the screen with your finger, you can control the selected functions.	16
2	Insert a disc into this slot. The CD player turns on immediately.	36
3	Press to customise the function settings.	117
4	Turn the tune/scroll knob to select a radio station or skip to the next or previous track. This knob can also be used to magnify or reduce the map scale.*	23, 178
5	Press to access the vehicle information system.	114
6	Press to access the Bluetooth® hands-free system and applications.	75, 231
7*	Press to access the navigation system.	167

No.	Function	Page
8	Press the ">" or "<" button to seek up or down for a radio station or to access a desired track or file.	28, 36, 41, 47, 56
9	Press to access the audio system. The audio system turns on in the last mode used.	24, 25, 26
10	Press the power/volume knob to turn navigation/multimedia system on and off, and turn it to adjust the volume.	25
11	Press to eject a disc.	27

*: Navigation system only

2. CONTROLS AND FEATURES

2. TOUCH SCREEN GESTURES

Operations are performed by touching the touch screen directly with your finger.

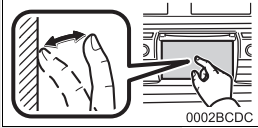
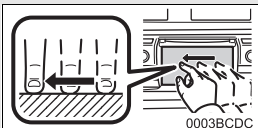
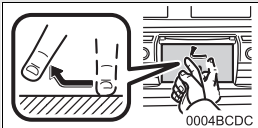
Operation method	Outline	Main use
	<p>Touch Quickly touch and release once.</p>	<p>Changing and selecting various settings.</p>
	<p>Drag* Touch the screen with your finger, and move the screen to the desired position.</p>	<ul style="list-style-type: none"> • Scrolling the lists • Using scroll bar in lists • Adjusting the zoom bar of the map (→P.178) • Adjusting manual tune scales for FM and AM (→P.31) • Adjusting the displayed screen's position sliders (→P.123) • Adjusting balance/fader (→P.150) • Moving position of elements in the stopover/destination list (→P.203, 204)
	<p>Flick* Quickly move the screen by flicking with your finger.</p>	<ul style="list-style-type: none"> • Scrolling the main screen page • Returning to the menu screen from the sub-menu screen (screen one level below) • Going to the next/previous picture (→P.235) • Going to the next/previous traffic message in the details view (→P.185) • Going to the next/previous route segment in the full screen view (turn list) (→P.206)

*: The above operations may not be performed on all screens.

2. CONTROLS AND FEATURES

3. TOUCH SCREEN OPERATION

This system is operated mainly by the screen buttons.

When a screen button is touched, a beep sounds. (To set a beep sound, →P.120.)



NOTICE

- To prevent damaging the screen, lightly touch the screen buttons with your finger.
- Do not use objects other than your finger to touch the screen.
- Wipe off fingerprints using a glass cleaning cloth. Do not use chemical cleaners to clean the screen, as they may damage the touch screen.
- To prevent the battery from being discharged, do not leave the system on longer than necessary when the engine is not running.

INFORMATION

- If the system does not respond to a touch on a screen button, move your finger away from the screen and then touch it again.
- Dimmed screen buttons cannot be operated.
- The displayed image may become darker and moving images may be slightly distorted when the display is cold.
- Under extremely cold conditions, the screen may not be displayed and the data input by a user may be deleted. Also, the screen buttons may be harder than usual to depress.
- When you look at the screen through polarized material such as polarized sunglasses, the screen may be dark and hard to see. If so, look at the screen from different angles, adjust the screen settings (→P.123), or take off your sunglasses.
- Select  to return to the previous screen.

1

ENTERING SCREEN OPERATION

When searching for a name, letters and numbers, etc. can be entered via the screen.

ENTERING LETTERS AND NUMBERS

- 1 Select the keys directly to enter letters or numbers.



No.	Function
1	Select to delete one letter. Select and hold to continue deleting letters.
2	Select to enter symbols.
3	Select to select lower case or upper case.
4	Select to change keyboard types.

- 2 Select "OK".

INFORMATION

- When a character is entered, a hint will appear displaying a possible match for the word to be searched.
- Currently unavailable screen buttons will be dimmed.
- When an entry is too long to be displayed in the enter field, the last section of the enter text will be displayed with the initial section displayed as "...".
- In the following situations, the enter mode will automatically change between upper and lower case.
 - When the keyboard layout is changed to upper case input, the layout will automatically change back to lower case input after one letter has been entered.
 - When "!", "&", ".", or "(" is entered, the keyboard layout will automatically be changed to upper case input.
 - When all characters are deleted, the keyboard layout will automatically change to upper case input.

ENTERING FROM THE LIST OF MATCHING ENTRIES

On certain screens, a candidate entry text or word prediction list based on the input letters will be displayed. The desired item can be selected and entered.

1 Enter letters.



- If a candidate entry text displayed in the enter field is what is desired, select “OK” or the candidate entry text.
- Select **14** to display the candidate entry text list. The number of matching items is shown. Up to 300 items are displayed.
- The list will be displayed automatically, if the number of matching entries is 5 or less.

2 Select the desired item.

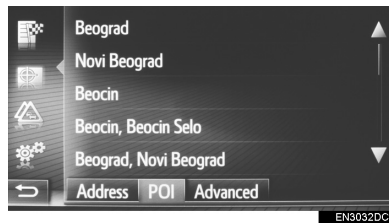

LIST SCREEN OPERATION

When a list is displayed, use the appropriate screen button to scroll through the list.

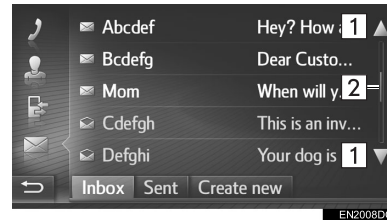

No.	Function
1	Select to shift to the next or previous page.
2	This indicates the displayed screen's position.

- By selecting and holding **▲** or **▼**, the screen can be scrolled up or down. Scrolling will automatically stop when the top/bottom of the list is reached.
- Changing pages can also be changed the following ways:
 - Selecting the desired point on the scroll bar.
 - Dragging the scroll bar marking to the desired point.

■ AUTOMATIC TEXT SCROLLING

Entries that are too long to fit in the current field are scrolled automatically from right to left.

This function is not available while driving.

INFORMATION

- This function can be changed to on or off. (→P.120)

CHARACTER JUMP BUTTONS IN LISTS

Some lists contain character screen buttons, “A-C”, “D-F” etc., which allow a direct jump to list entries that begin with the same letter as the character screen button.

- 1 Select one of the character screen buttons.

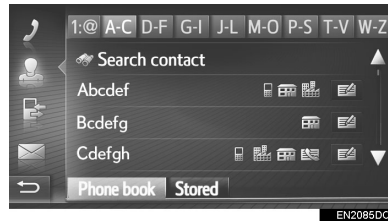

INFORMATION

- Every time the same character screen button is selected, the list starting with the subsequent character is displayed.

1 BASIC OPERATION

1. QUICK REFERENCE	24
2. SOME BASICS.....	25
TURNING THE AUDIO SYSTEM ON OR OFF	25
SELECTING AN AUDIO SOURCE.....	26
INSERTING OR EJECTING A DISC	26
USB/AUX PORT	27

2 RADIO OPERATION

1. AM/FM/DAB RADIO.....	28
OVERVIEW	28
PRESETTING A STATION.....	31
MANUAL TUNING	31
RDS (RADIO DATA SYSTEM).....	32
TIME SHIFT OPERATION (DAB).....	33
RADIO OPTIONS	34

2

AUDIO SYSTEM

3 MEDIA OPERATION

1. CD	36
OVERVIEW.....	36
PLAYING AN AUDIO CD.....	39
PLAYING AN MP3/WMA/AAC DISC.....	39
AUDIO CD OR MP3/WMA/AAC DISC OPTIONS.....	40
2. USB MEMORY	41
OVERVIEW.....	41
PLAYING A USB MEMORY.....	45
USB MEMORY OPTIONS.....	46
3. iPod	47
OVERVIEW.....	47
iPod AUDIO.....	51
iPod AUDIO OPTIONS.....	52
4. AUX	53
OVERVIEW.....	53
5. Bluetooth® AUDIO	56
OVERVIEW.....	56
CONNECTING Bluetooth® AUDIO.....	60
LISTENING TO Bluetooth® AUDIO.....	61
Bluetooth® AUDIO OPTIONS.....	61

4 AUDIO REMOTE CONTROLS

1. STEERING SWITCHES	63
-----------------------------------	-----------

5 TIPS FOR OPERATING THE AUDIO SYSTEM

1. OPERATING INFORMATION	65
RADIO RECEPTION.....	65
iPod.....	67
CARING FOR YOUR CD PLAYER AND DISCS.....	68
FILE INFORMATION.....	70
CD-R AND CD-RW DISCS.....	72
TERMS.....	72

1

2

3

4

5

6

7

8

9

Some of the functions cannot be operated while driving.

1. BASIC OPERATION

1. QUICK REFERENCE

To access the audio system, press the “**MEDIA**” button. The audio system turns on in the last mode used.

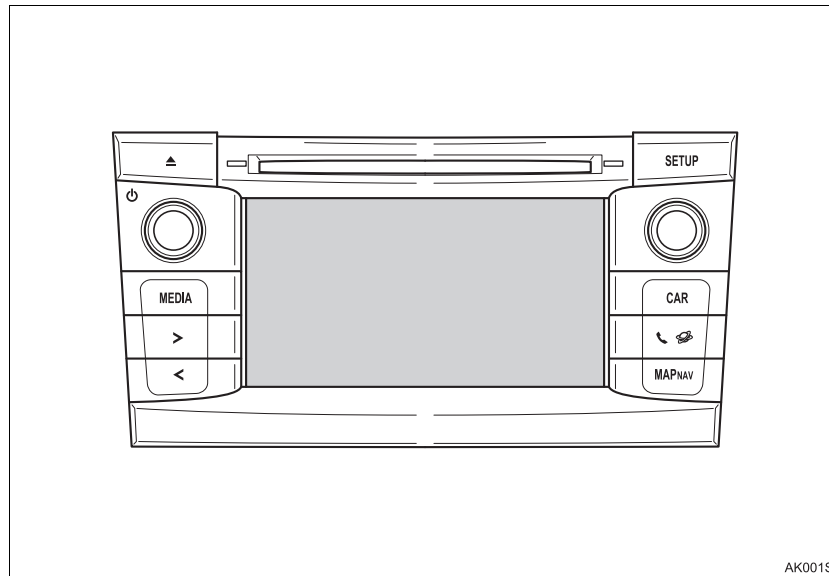

AK001S

Function	Page
Using the radio	28
Playing an audio CD or MP3/WMA/AAC disc	36
Playing a USB memory	41
Playing an iPod	47
Using the AUX port	53
Playing a Bluetooth® device	56
Using the steering wheel audio switches	63
Audio settings	149

1. BASIC OPERATION

2. SOME BASICS

This section describes some of the basic features of the audio system. Some information may not pertain to your system.

▶ Vehicles without smart entry & start system

Your audio system works when the engine switch is turned to the “ACC” or “ON” position.

▶ Vehicles with smart entry & start system

Your audio system works when the engine switch is turned to ACCESSORY or IGNITION ON mode.

⚠ CAUTION

CAUTION:
THIS PRODUCT IS A CLASS 1 LASER PRODUCT. USE OF CONTROLS OR ADJUSTMENTS OR PERFORMANCE OF PROCEDURES OTHER THAN THOSE SPECIFIED HEREIN MAY RESULT IN HAZARDOUS RADIATION EXPOSURE. DO NOT OPEN COVERS AND DO NOT REPAIR BY YOURSELF. REFER SERVICING TO QUALIFIED PERSONNEL.

⚠ NOTICE

- To prevent the battery from being discharged, do not leave the audio system on longer than necessary when the engine is not running.

TURNING THE AUDIO SYSTEM ON OR OFF

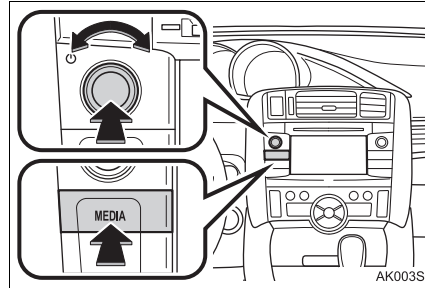

The power/volume knob: Press this knob to turn the audio system on and off. Turn this knob to adjust the volume. The system turns on in the last mode used.

“**MEDIA**” button: Press this button to display screen buttons for the audio system.

INFORMATION

- If the volume is adjusted while music is paused or muted, the pause or mute will be cancelled.

2

AUDIO SYSTEM

1. BASIC OPERATION

SELECTING AN AUDIO SOURCE

- 1 Press the **"MEDIA"** button.

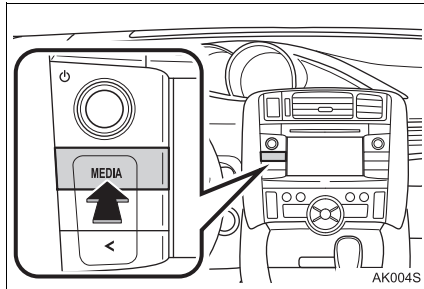

- The audio system turns on in the last mode used.
- 2 Select  or press the **"MEDIA"** button to display the audio source selection screen.

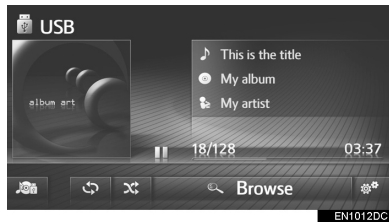

- 3 Select a desired audio source.

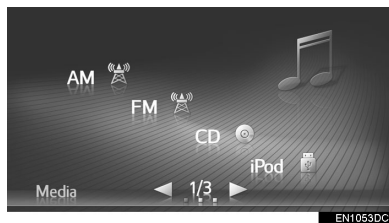

INFORMATION

- You cannot select dimmed screen buttons.

INSERTING OR EJECTING A DISC

INSERTING A DISC

- 1 Insert a disc with the label side up.

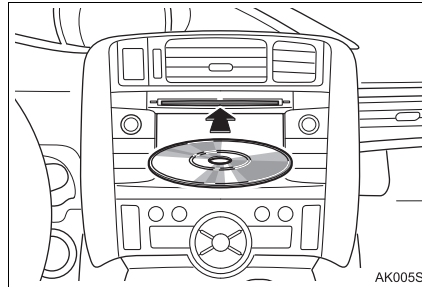

- When a disc is correctly inserted into the slot, the CD player will automatically start playing from the first track or the first track of the first folder on a disc.

INFORMATION

- If the label is facing down, "Disc error occurred" will appear on the screen.

NOTICE

- Never try to disassemble or oil any part of the CD player. Do not insert anything other than a disc into the slot.

EJECTING A DISC

- 1 Press the ▲ button.

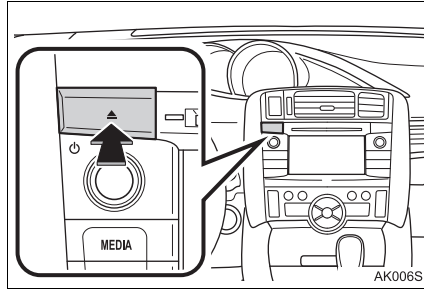

- The disc will be ejected.

USB/AUX PORT

- 1 Open the cover of the USB/AUX port.

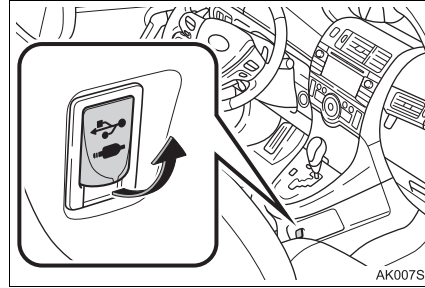

- 2 Connect a device.

- If a device is inserted, it starts playing automatically. As soon as it is ready to play, the audio control screen is shown automatically.
- If a USB hub is plugged-in, two devices can be connected at a time.
- Even if a USB hub is used to connect more than two USB devices, only the first two connected devices will be recognized.

2

AUDIO SYSTEM

2. RADIO OPERATION

1. AM/FM/DAB* RADIO

OVERVIEW

The radio operation screen can be reached by the following method:
Press the **"MEDIA"** button to display the audio source selection screen, then select **"AM"**, **"FM"** or **"DAB"** to display the radio control screen.

■ CONTROL PANEL

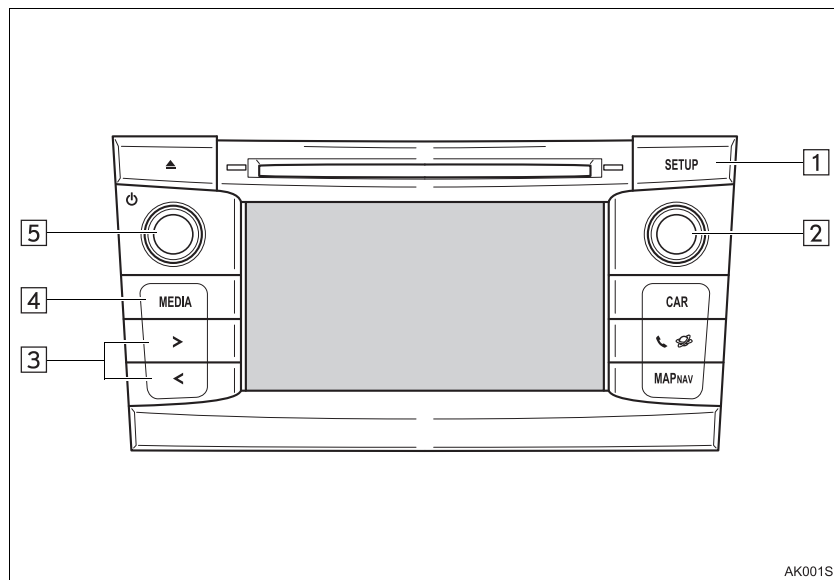

*: If equipped

■ CONTROL SCREEN

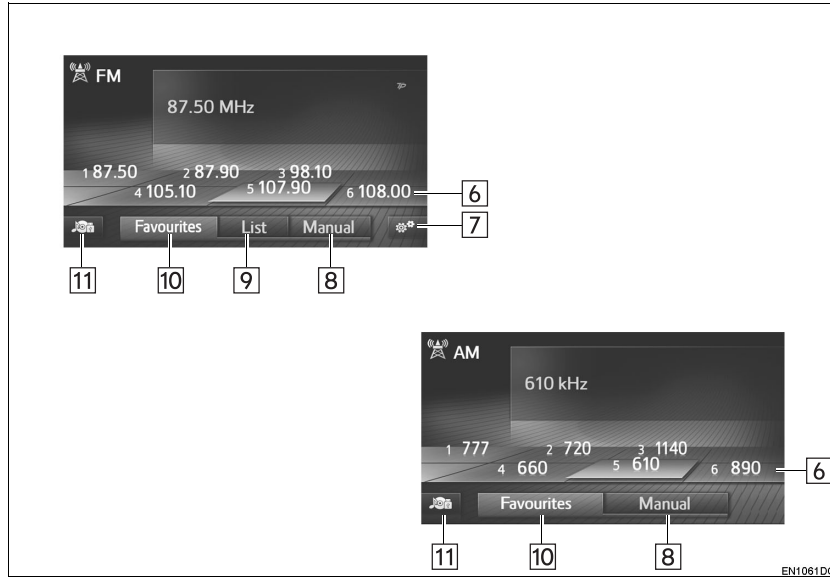

2

AUDIO SYSTEM

2. RADIO OPERATION

No.	Function
1	Select to set the sound settings. (→P.149)
2	The tune/scroll knob: <ul style="list-style-type: none">• Preset tuning screen: Turn to select a preset station.• Station list screen: Turn to move up/down the station list.• Manual tuning screen: Turn to step up/down frequencies.• DAB time shift screen: Turn to jump forward/backwards.
3	<ul style="list-style-type: none">• Preset tuning screen: Press to move up/down the preset stations.• Station list screen: Press to move up/down the station list.• Manual tuning screen: Press and hold to seek up/down available stations while being pressed.
4	Press to display the media mode selection screen.
5	The power/volume knob: <ul style="list-style-type: none">• Turn to adjust volume.• Press to turn the audio system on/off.
6	Select to tune to preset stations.
7	Select to display the radio options screen.
8	Select to display the manual tuning screen.
9	Select to display the station list.
10	Select to display the preset station.
11	Select to display the audio source selection screen.

INFORMATION

- The radio automatically changes to stereo reception when a stereo broadcast is received.

PRESETTING A STATION

- 1 Select **"Favourites"**.
- 2 Tune in the desired station.
- 3 Select one of the station selector buttons **(1-6)** and hold it until a beep is heard.

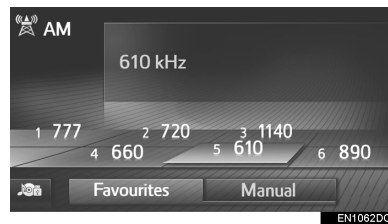

- The station's frequency (AM/FM) or name (FM/DAB) will be displayed in the screen button.
- To change the preset station to a different one, follow the same procedure.

MANUAL TUNING

▶ AM/FM

- 1 Select **"Manual"**.

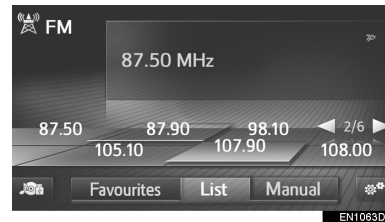

- 2 Tune the desired station.

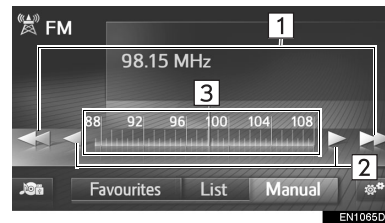

No.	Function
1	<ul style="list-style-type: none"> • Select to move up/down a station. • Select and hold to seek stations non-stop. When released, the currently received station will be selected.
2	<ul style="list-style-type: none"> • Select to step up/down frequencies. • Select and hold to seek frequencies non-stop. When released, the system will stop at the current frequency.
3	<p>It is possible to drag and drop the marker by sliding your finger on the screen (in the area where the marker is shown). Relocating the marker by a single select on the frequency band by a single select on the frequency band is also possible.</p>

2

AUDIO SYSTEM

2. RADIO OPERATION

► DAB*

1 Select **“Manual”**.

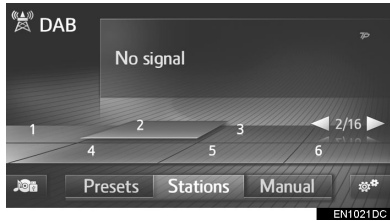

2 Tune the desired ensemble or service.

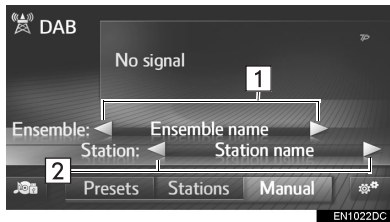

No.	Function
1	<ul style="list-style-type: none"> Select to seek up/down available ensembles. Select and hold the button for the non-stop seek up/down function. When your finger is released from the button, the search function will stop at the next receivable station.
2	Select to set available service. <ul style="list-style-type: none"> ► Multimedia system Select and hold to set the available services every one second.

RDS (RADIO DATA SYSTEM)

Depending on the availability of RDS infrastructure, the service may not function.

FM ALTERNATIVE FREQUENCY (AF)

A better reception frequency of the same broadcasting program will be automatically tuned if the reception of the current frequency degrades.

REGIONAL CODE CHANGE

OFF mode: For switching over to a broadcasting station within the same RDS network; convenient for following the appropriate stations in a wide region.

ON mode: For switching over to a broadcasting station within the same local program network.

*: If equipped

TA (TRAFFIC ANNOUNCEMENT) FUNCTION

The tuner will automatically seek a station that regularly broadcasts traffic information and the station broadcasts when the traffic information program starts.

- 1 A pop-up message is displayed on the screen when the radio seeks out a TP station.
- 2 Select **“Continue”**.

INFORMATION

- When TA is set to on (→P.34), the radio will begin seeking a TP station.
- When the program ends, the initial operation resumes.

TRAFFIC ANNOUNCEMENT VOLUME

The volume level of a received traffic information sound is stored in the memory.



TIME SHIFT OPERATION (DAB*)

The service you are currently listening to can be re-listened to at any time.

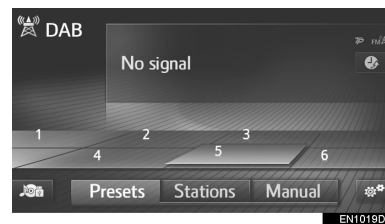
- 1 Select .



- ▶ Using the touch screen

- 2 Select  or  to jump forward/backward by 10 seconds.

Select and hold  or  to fast forward/rewind.



2

AUDIO SYSTEM

*: If equipped

► Using the tune/scroll knob

2 Turn the tune/scroll knob.

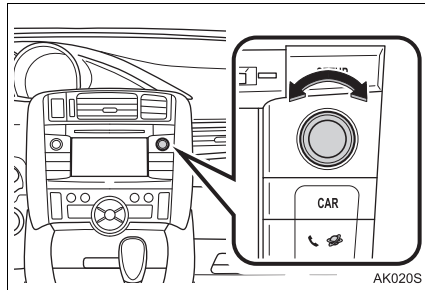

- The time can be set in intervals of 10 seconds.

INFORMATION

- The times at which playback is possible depend on the bit rate of the DAB station to be recorded, the amount of DAB unit memory, and the time at which reception of the broadcast began.

RADIO OPTIONS

FM RADIO OPTIONS

- 1 Display the FM radio control screen. (→P.28)
- 2 Select .
- 3 Select the button to be set.

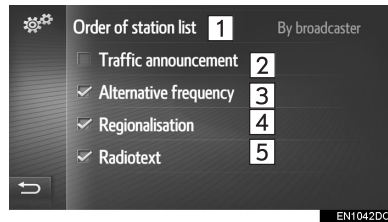

No.	Function
1	Select to select "By broadcaster" or "Alphabetical" for the listing order of the station list.
2	The tuner will automatically seek a station that regularly broadcasts traffic information and the station broadcasts when the traffic information program starts.
3	Select to set automatic selection of a station providing good reception if current reception worsens on/off.
4	Select to switch to a broadcasting station within the same local program network.
5	Select to set the FM radio text feature on/off.

INFORMATION

- The current setting of each item is displayed on its right.

DAB OPTIONS*

- 1 Display the DAB control screen.
(→P.28)
- 2 Select .
- 3 Select the button to be set.

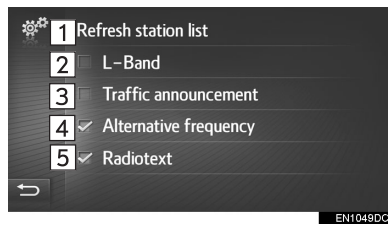

No.	Function
1	Select to update the DAB station list.
2	Select to set the L-band in the tuning range on/off. When set to off, the physical channel range for tuning operations is limited to Band III, excluding preset operations. When selected to on, the physical channel range for tuning operations includes Band III and the L-band.
3	Select to set automatic seeking of a station that regularly broadcasts traffic information on/off. When set to on and traffic information is received, a pop-up window will come up.
4	Select to set automatic selection of a station providing good reception if current reception worsens on/off.
5	Select to set the DAB text feature on/off.

2

AUDIO SYSTEM

*: If equipped

3. MEDIA OPERATION

1. CD

OVERVIEW

The CD operation screen can be reached by the following methods:

- ▶ Inserting a disc (→P.26)
- ▶ Press the “**MEDIA**” button to display the audio source selection screen, then select “**CD**” to display the CD control screen.

■ CONTROL PANEL

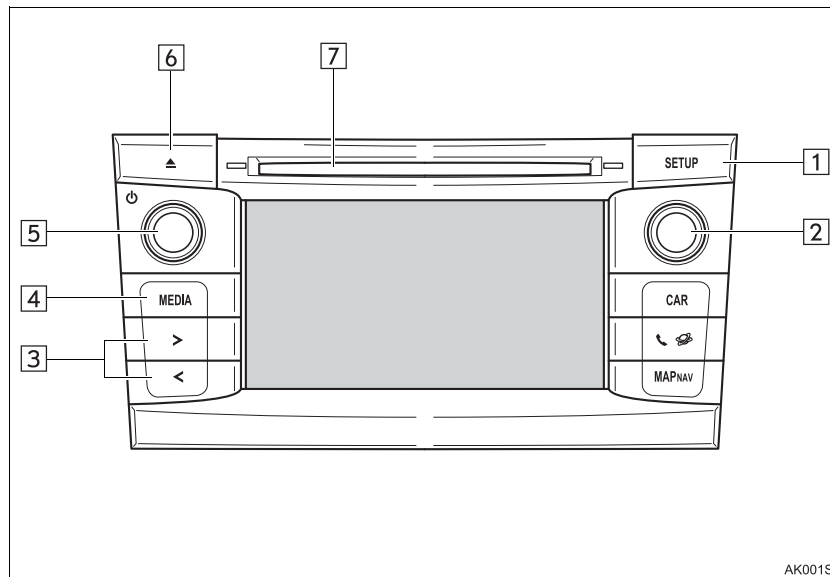

■ CONTROL SCREEN

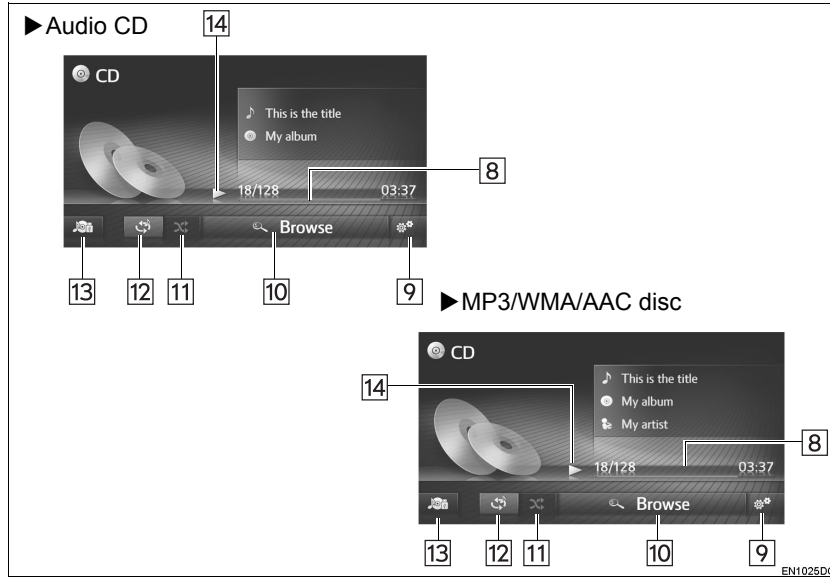

2

AUDIO SYSTEM

3. MEDIA OPERATION

No.	Function
1	Select to set the sound settings. (→P.149)
2	The tune/scroll knob: <ul style="list-style-type: none">• Turn to select a track.• Turn to move up/down the list.
3	<ul style="list-style-type: none">• Press to select a track.• Press and hold to fast forward/rewind.
4	Press to display the media mode selection screen.
5	The power/volume knob: <ul style="list-style-type: none">• Turn to adjust volume.• Press to turn the audio system on/off.
6	Press to eject a disc.
7	Disc slot
8	Shows progress
9	Select to display audio CD, MP3/WMA/AAC disc options screen.
10	<ul style="list-style-type: none">• Audio CD: Select to display a track list.• MP3/WMA/AAC disc: Select to display a folder list.
11	Select to set random playback.
12	Select to set repeat playback.
13	Select to display the media source selection screen.
14	Select to play/pause.

INFORMATION

- If a disc contains CD-DA files and MP3/WMA/AAC files, only the CD-DA files can be played back.
- If a CD-TEXT disc is inserted, the title of the disc and track will be displayed.
- If the disc contains no CD-TEXT, only the track number would be displayed on the screen.

PLAYING AN AUDIO CD

REPEATING

The track currently being listened to can be repeated.

1 Select .

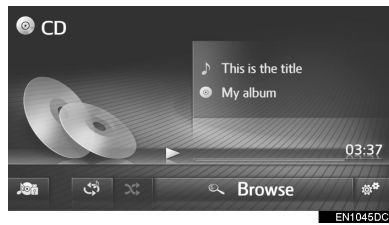



- Each time  is selected, the mode changes as follows:
 - track repeat → off

RANDOM ORDER

Tracks can be automatically and randomly selected.

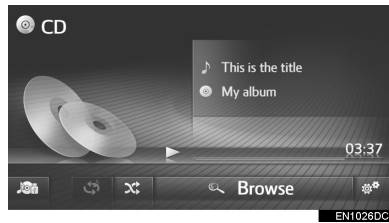
1 Select .



- Each time  is selected, the mode changes as follows:
 - random → off

PLAYING AN MP3/WMA/AAC DISC

REPEATING

The track or folder currently being listened to can be repeated.

1 Select .

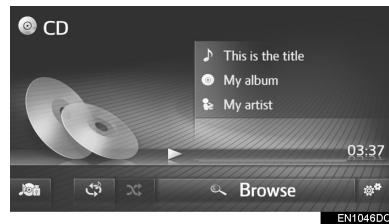



- Each time  is selected, the mode changes as follows:
 - track repeat → folder repeat → off

RANDOM ORDER

Tracks can be automatically and randomly selected.

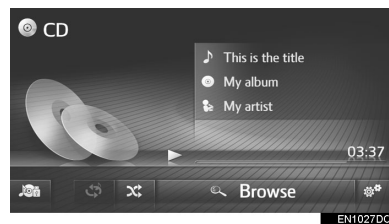
1 Select .



- Each time  is selected, the mode changes as follows:
 - random → off

2

AUDIO SYSTEM

AUDIO CD OR MP3/WMA/AAC DISC OPTIONS

- 1 Display the CD control screen.
(→P.36)
- 2 Select .
- 3 Select the button to be set.

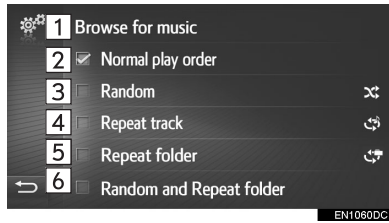

No.	Function
1	<ul style="list-style-type: none"> • Audio CD: Select to display a track list. • MP3/WMA/AAC disc: Select to display a folder list.
2	Select to resume playback of tracks from the beginning of the track list when the playback of the last track on the list is finished.
3	Select to set random playback track.
4	Select to set repeat playback track.
5 ^{*1}	Select to set repeat playback folder.
6 ^{*1, 2}	Select to set random and repeat playback folder.

*1: MP3/WMA/AAC disc only

*2: Navigation system only

3. MEDIA OPERATION

2. USB MEMORY

OVERVIEW

The USB memory operation screen can be reached by the following methods:

- ▶ Connecting a USB memory (→P.27)
- ▶ Press the “**MEDIA**” button to display the audio source selection screen, then select “**USB**” to display the USB memory control screen.

2

AUDIO SYSTEM

■ CONTROL PANEL

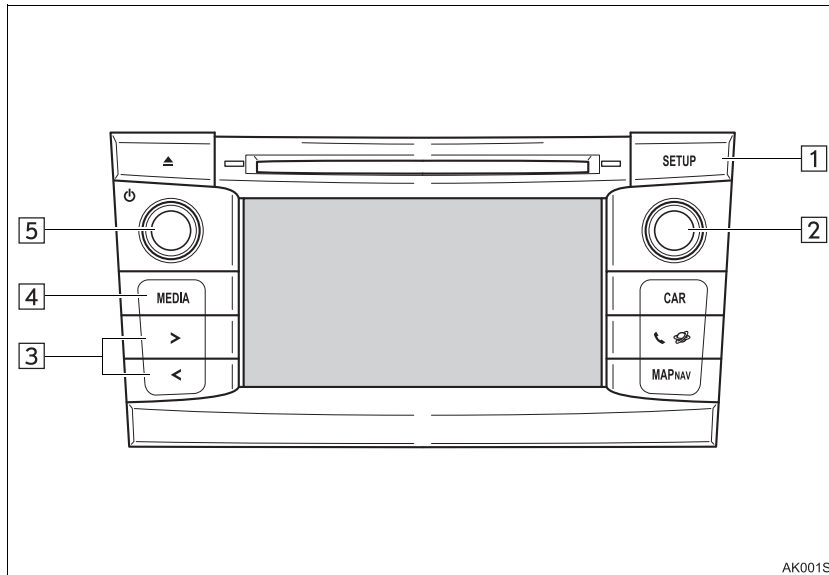

■ CONTROL SCREEN

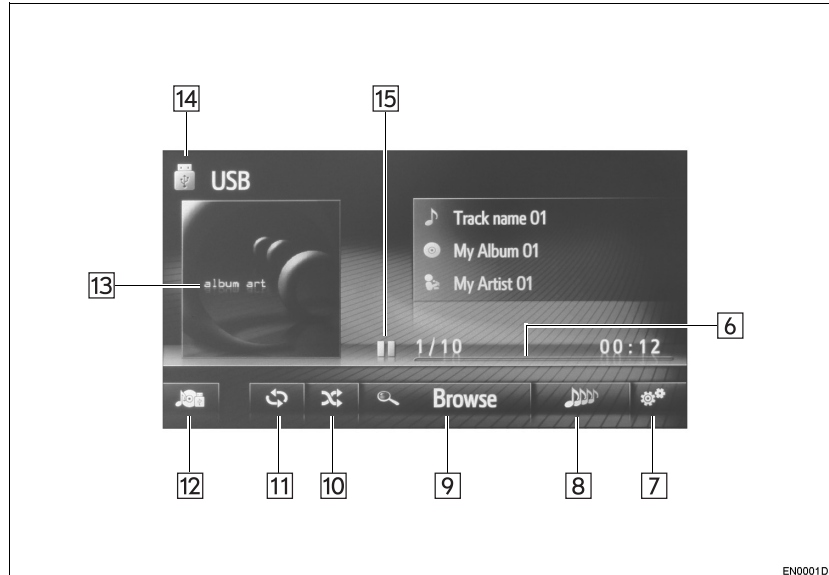

No.	Function
1	Select to set the sound settings. (→P.149)
2	The tune/scroll knob: <ul style="list-style-type: none"> • Turn to select a track. • Turn to move up/down the list.
3	<ul style="list-style-type: none"> • Press to select a track. • Press and hold to fast forward/rewind.
4	Press to display the media mode selection screen.
5	The power/volume knob: <ul style="list-style-type: none"> • Turn to adjust volume. • Press to turn the audio system on/off.
6	Shows progress
7	Select to display the USB options screen.
8*	Select to create a new playlist containing songs similar to the current song being played.
9	Select to display the browse options selection screen and then select the desired item.
10	Select to set random playback.
11	Select to set repeat playback.
12	Select to display the media source selection screen.
13	<ul style="list-style-type: none"> • Displays cover art. • Select to display a track list.
14	Select to switch between "USB1" and "USB2" when 2 USB memory devices are connected.
15	Select to play/pause.

2

AUDIO SYSTEM

*: If equipped

3. MEDIA OPERATION

CAUTION

- Do not operate the player's controls or connect the USB memory while driving.

NOTICE

- Depending on the size and shape of the USB memory that is connected to the system, the passenger's seat may hit the USB memory when moving the seat forward. In this case, do not forcibly move the seat forward as this may damage the USB memory or the terminal, etc.
- Do not leave a portable player in the vehicle. In particular, high temperatures inside the vehicle may damage the portable player.
- Do not push down on or apply unnecessary pressure to the portable player while it is connected as this may damage the portable player or its connector.
- Do not insert foreign objects into the port as this may damage the portable player or its connector.

INFORMATION

- Navigation system only: This system supports MTP devices.

PLAYING A USB MEMORY

REPEATING

The track currently being listened to can be repeated.

1 Select .

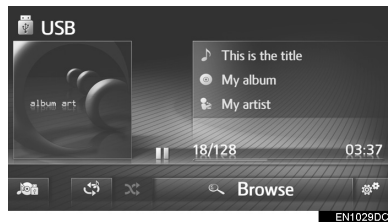



- Each time  is selected, the mode changes as follows:
 - track repeat → off

RANDOM ORDER

Tracks can be automatically and randomly selected.

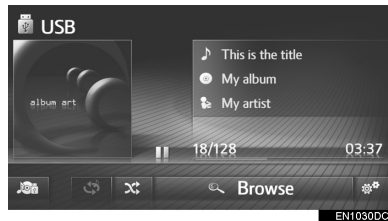
1 Select .



- Each time  is selected, the mode changes as follows:
 - random → off

CREATE SIMILAR SONGS PLAYLIST*

The system create a new playlist containing songs similar to the current song being played.

1 Select .

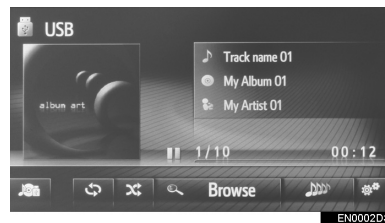

2

AUDIO SYSTEM

*: If equipped

USB MEMORY OPTIONS

- 1 Display the USB memory control screen. (→P.41)
- 2 Select .
- 3 Select the button to be set.

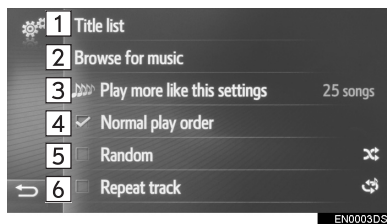

No.	Function
1	Select to display a track list.
2	Select to display the browse options selection screen and then select the desired item.
3*	Select to choose the size of the playlist of similar songs between 25, 50 and 100 songs.
4	Select to resume playback of tracks from the beginning of the track list when the playback of the last track on the list is finished.
5	Select to set random playback.
6	Select to set repeat playback track.

*: If equipped

3. MEDIA OPERATION

3. iPod

OVERVIEW

The iPod operation screen can be reached by the following methods:

- ▶ Connecting an iPod (→P.27)
- ▶ Press the **"MEDIA"** button to display the audio source selection screen, then select **"iPod"** to display the iPod control screen.

2

AUDIO SYSTEM

■ CONTROL PANEL

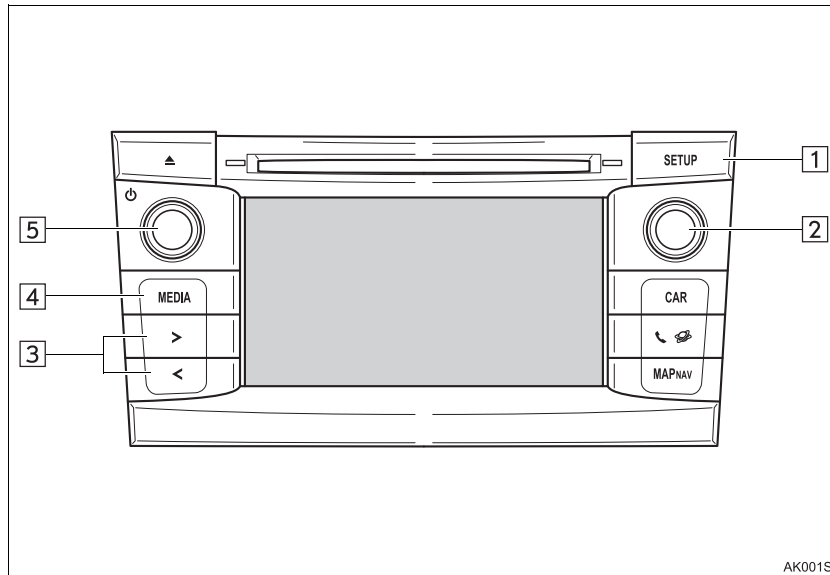

■ CONTROL SCREEN

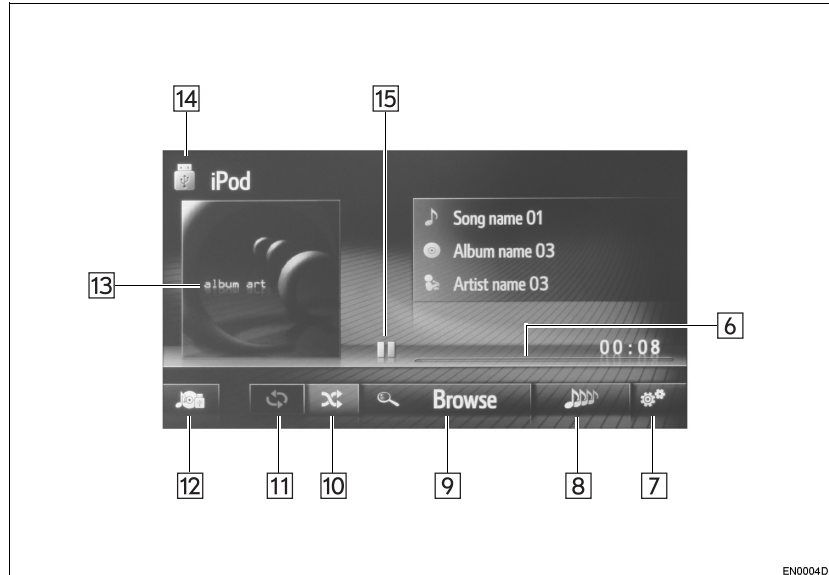

EN0004DS

No.	Function
1	Select to set the sound settings. (→P.149)
2	The tune/scroll knob: <ul style="list-style-type: none"> • Turn to select a track. • Turn to move up/down the list.
3	<ul style="list-style-type: none"> • Press to select a track. • Press and hold to fast forward/rewind.
4	Press to display the media mode selection screen.
5	The power/volume knob: <ul style="list-style-type: none"> • Turn to adjust volume. • Press to turn the audio system on/off.
6	Shows progress
7	Select to display the iPod audio options screen.
8*	Select to create a new playlist containing songs similar to the current song being played.
9	Select to display the browse options selection screen and then select the desired item.
10	Select to set random playback.
11	Select to set repeat playback.
12	Select to display the media source selection screen.
13	<ul style="list-style-type: none"> • Displays cover art. • Select to display a track list.
14	Select to switch between "iPod1" and "iPod2" when 2 iPods are connected.
15	Select to play/pause.

2

AUDIO SYSTEM

*: If equipped

3. MEDIA OPERATION

CAUTION

- Do not operate the player's controls or connect the iPod while driving.

NOTICE

- Do not leave a portable player in the vehicle. In particular, high temperatures inside the vehicle may damage the portable player.
- Do not push down on or apply unnecessary pressure to the portable player while it is connected as this may damage the portable player or its connector.
- Do not insert foreign objects into the port as this may damage the portable player or its connector.

INFORMATION

- When an iPod is connected using a genuine iPod cable, the iPod starts charging its battery.
- Depending on the iPod and the songs in the iPod, iPod cover art may be displayed. It may take time to display iPod cover art, and the iPod may not be operated while the cover art display is in process. Only iPod cover art that is saved in JPEG format can be displayed.
- When an iPod is connected and the audio source is changed to iPod mode, the iPod will resume playing from the same point it was last used.
- Depending on the iPod that is connected to the system, certain functions may not be available.

iPod AUDIO

REPEATING

The track currently being listened to can be repeated.

1 Select .

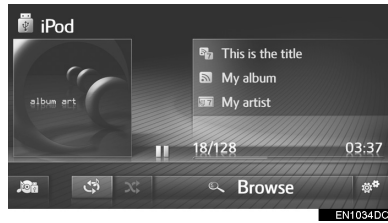



- Each time  is selected, the mode changes as follows:
 - track repeat → off

RANDOM ORDER

Tracks can be automatically and randomly selected.

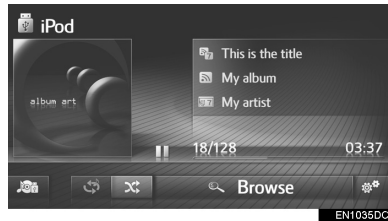
1 Select .



- Each time  is selected, the mode changes as follows:
 - random → off

CREATE SIMILAR SONGS PLAYLIST*

The system create a new playlist containing songs similar to the current song being played.

1 Select .

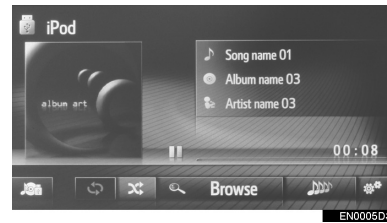

2

AUDIO SYSTEM

*: If equipped

iPod AUDIO OPTIONS

- 1 Display the iPod control screen.
(→P.47)
- 2 Select .
- 3 Select the button to be set.

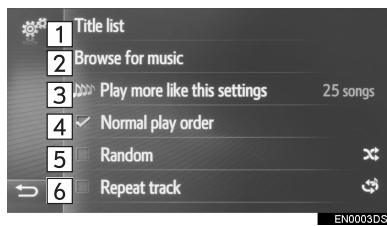

No.	Function
1	Select to display a track list.
2	Select to display the browse options selection screen and then select the desired item.
3*	Select to choose the size of the playlist of similar songs between 25, 50 and 100 songs.
4	Select to resume playback of tracks from the beginning of the track list when the playback of the last track on the list is finished.
5	Select to set random playback.
6	Select to set repeat playback track.

*: If equipped

3. MEDIA OPERATION

4. AUX

OVERVIEW

The AUX operation screen can be reached by the following methods:

- ▶ Connecting a device to the AUX port (→P.27)
- ▶ Press the “**MEDIA**” button to display the audio source selection screen, then select “**AUX**” to display the AUX control screen.

2

AUDIO SYSTEM

■ CONTROL PANEL

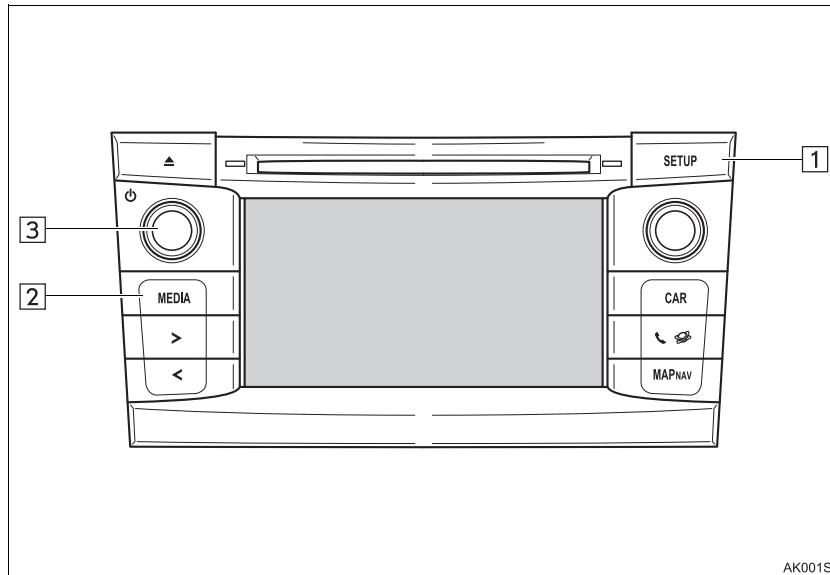

AK001S

■ CONTROL SCREEN

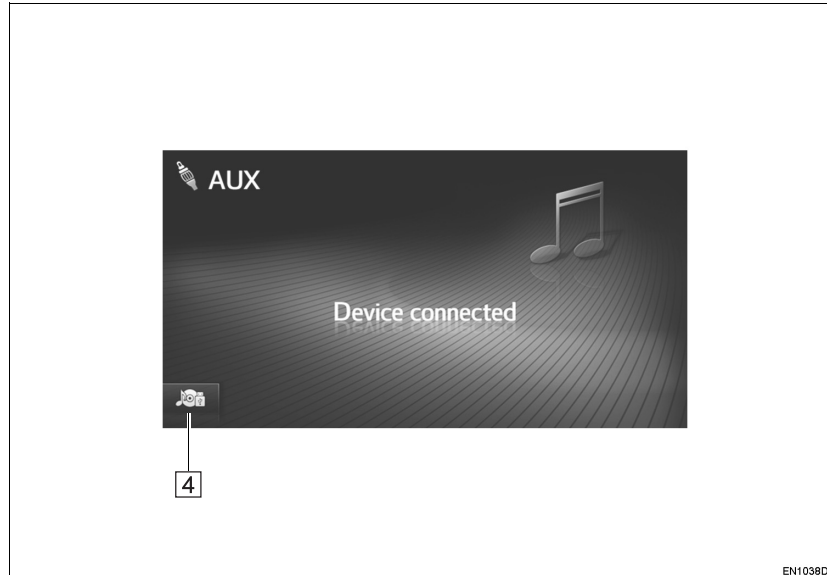

No.	Function
1	Select to set the sound settings. (→P.149)
2	Press to display the media mode selection screen.
3	The power/volume knob: <ul style="list-style-type: none"> • Turn to adjust volume. • Press to turn the audio system on/off.
4	Select to display the media source selection screen.

 **CAUTION**

- Do not connect portable audio device or operate the controls while driving.

 **NOTICE**

- Do not leave a portable audio device in the vehicle. The temperature inside the vehicle may become high, resulting in damage to the player.
- Do not push down on or apply unnecessary pressure to the portable audio device while it is connected as this may damage the portable audio device or its connector.
- Do not insert foreign objects into the port as this may damage the portable audio device or its connector.

2

AUDIO SYSTEM

3. MEDIA OPERATION

5. Bluetooth® AUDIO

The Bluetooth® audio system enables users to enjoy listening to music that is played on a portable player on the vehicle speakers via wireless communication.

This audio system supports Bluetooth®, a wireless data system capable of playing portable audio music without cables. If your device does not support Bluetooth®, the Bluetooth® audio system will not function.

OVERVIEW

The Bluetooth® audio operation screen can be reached by the following methods. Depending on the type of portable player connected, some functions may not be available and/or the screen may look differently than shown in this manual.

- ▶ Connecting a Bluetooth® audio device (→P.60)
- ▶ Press the **“MEDIA”** button to display the audio source selection screen, then select **“Bluetooth*”** to display the Bluetooth® control screen.

■ CONTROL PANEL

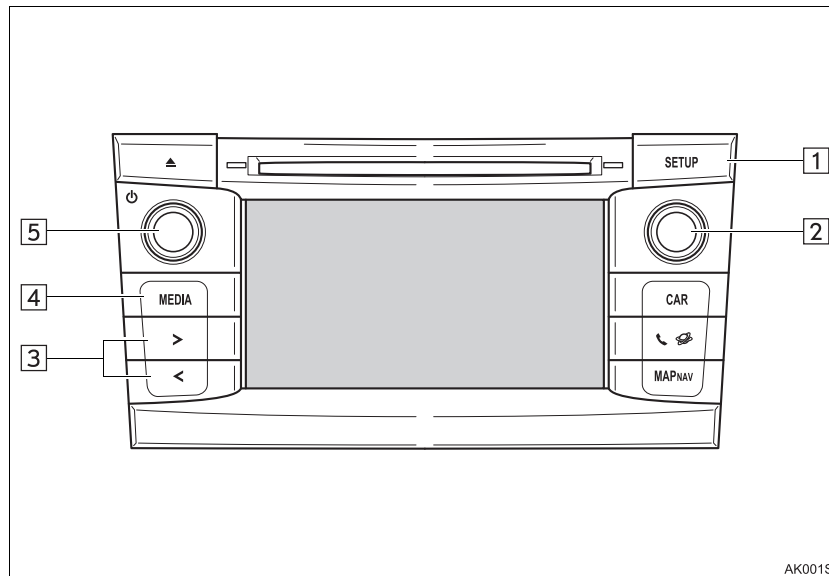

*: Bluetooth is a registered trademark of Bluetooth SIG, Inc.

■ CONTROL SCREEN

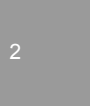
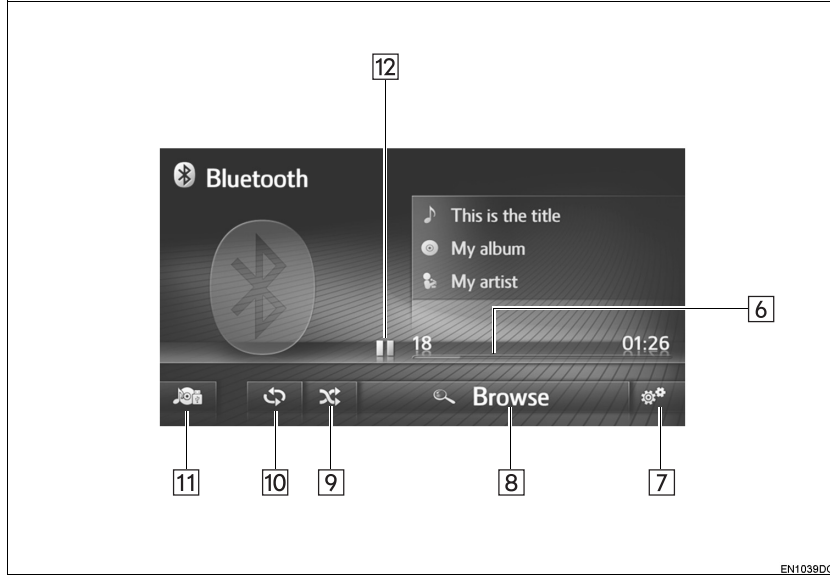

AUDIO SYSTEM

3. MEDIA OPERATION

No.	Function
1	Select to set the sound settings. (→P.149)
2	The tune/scroll knob: <ul style="list-style-type: none">• Turn to select a track.• Turn to move up/down the list.
3	<ul style="list-style-type: none">• Press to select a track.• Press and hold to fast forward/rewind.
4	Press to display the media mode selection screen.
5	The power/volume knob: <ul style="list-style-type: none">• Turn to adjust volume.• Press to turn the audio system on/off.
6	Shows progress
7	Select to display the Bluetooth® audio options screen.
8	Select to display the browse options selection screen and then select the desired item.
9	Select to set random playback.
10	Select to set repeat playback.
11	Select to display the media source selection screen.
12	Select to play/pause.

CAUTION

- Do not operate the player's controls or connect to the Bluetooth® audio system while driving.
- Your audio unit is fitted with Bluetooth® antennas. People with implantable cardiac pacemakers, cardiac resynchronization therapy-pacemakers or implantable cardioverter defibrillators should maintain a reasonable distance between themselves and the Bluetooth® antennas. The radio waves may affect the operation of such devices.
- Before using Bluetooth® devices, users of any electrical medical device other than implantable cardiac pacemakers, cardiac resynchronization therapy-pacemakers or implantable cardioverter defibrillators should consult the manufacturer of the device for information about its operation under the influence of radio waves. Radio waves could have unexpected effects on the operation of such medical devices.

NOTICE

- Do not leave a portable player in the vehicle. In particular, high temperatures inside the vehicle may damage the portable player.

INFORMATION

- In the following conditions, this system may not function:
 - The Bluetooth® device is turned off.
 - The Bluetooth® device is not connected.
 - The Bluetooth® device has a low battery.
- It may take time to connect the telephone when Bluetooth® audio is being played.
- For operating a portable player, see the instruction manual that came with it.
- If the Bluetooth® device is disconnected due to poor reception from the Bluetooth® network when the engine switch is in the following status, the system will automatically reconnect to the portable player.
 - ▶ Vehicles without smart entry & start system
The engine switch is turned to the "ACC" or "ON" position.
 - ▶ Vehicles with smart entry & start system
The engine switch is turned to ACCESSORY or IGNITION ON mode.
- If the Bluetooth® device is disconnected by turning it off, automatic reconnection will not take place. Reconnect the portable player manually.
- Bluetooth® device information is registered when the portable player is connected to the Bluetooth® audio system. When selling or disposing of the vehicle, remove the Bluetooth® audio information from the system.

CONNECTING Bluetooth® AUDIO

In order to use the Bluetooth® audio system, it is necessary to pair a portable player and connect the audio profile (A2DP) with the system.

Once you have connected a device with audio profile (A2DP), you can enjoy your music on the vehicle's audio system.

If you have not yet connected a portable player with audio profile (A2DP), you must first connect a portable player with audio profile (A2DP) according to the following procedures. Connect your portable player with audio profile (A2DP) after bringing the vehicle to a complete stop.

■ IF NO DEVICE HAS BEEN CONNECTED

- ▶ Multimedia system (→P.126)
- ▶ Navigation system (→P.133)

■ CONNECTING AN ADDITIONAL DEVICE

- ▶ Multimedia system (→P.126)
- ▶ Navigation system (→P.133)

■ SELECTING A CONNECTED DEVICE

- ▶ Multimedia system (→P.130)
- ▶ Navigation system (→P.140)

LISTENING TO Bluetooth® AUDIO

REPEATING

The track currently being listened to can be repeated.

- 1 Select .

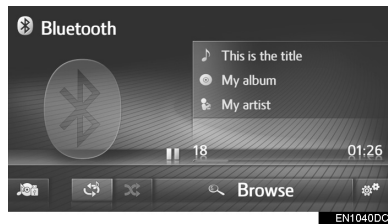

- Each time  is selected, the mode changes as follows:
 - track repeat → off

RANDOM ORDER

Tracks can be automatically and randomly selected.

- 1 Select .

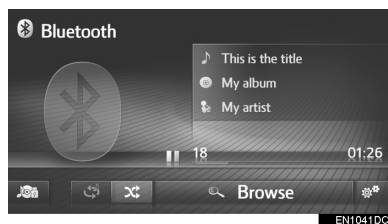

- Each time  is selected, the mode changes as follows:
 - random → off

Bluetooth® AUDIO OPTIONS

- 1 Display the Bluetooth® control screen. (→P.56)
- 2 Select .
- 3 Select the button to be set.

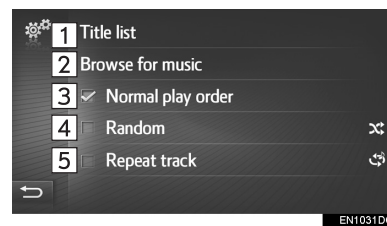

No.	Function
1	Select to display a track list.
2	Select to display the browse options selection screen and then select the desired item.
3	Select to resume playback of tracks from the beginning of the track list when the playback of the last track on the list is finished.
4	Select to set random playback.
5	Select to set repeat playback track.

2

AUDIO SYSTEM

3. MEDIA OPERATION

INFORMATION

- If a portable device supports AVRCP 1.4 and browsing, title list and browse for music will be available. (If the device does not support browsing, these menu entries will be displayed grayed out.) Lower grade devices do not support these features.
For these devices, the title list and browse for music will be displayed grayed out.

4. AUDIO REMOTE CONTROLS

1. STEERING SWITCHES

Some parts of the navigation/multimedia system can be adjusted with the switches on the steering wheel.

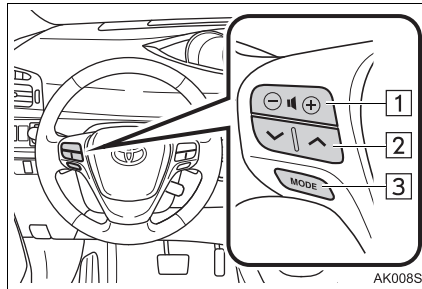

2

AUDIO SYSTEM

No.	Switch
1	Volume control switch
2	“^” “v” switch
3	“MODE” switch

► Volume control switch

Mode	Operation	Function
All	Press	Volume up/down

4. AUDIO REMOTE CONTROLS

▶“^”“v” switch

Mode	Operation	Function
AM/FM Radio	Press	Preset station up/down (Preset tuning screen) Station list up/down (Station list screen) Seek up/down (Manual tuning screen)
	Press and hold	Non stop seek up/down (Manual tuning screen)
DAB	Press	Preset station up/down (Preset tuning screen) Station list up/down (Station list screen) ▶ Navigation system Service seek up/down (Manual tuning screen) ▶ Multimedia system Ensemble seek up/down (Manual tuning screen)
	Press and hold	▶ Multimedia system Non stop ensemble seek up/down (Manual tuning screen)
Audio CD, MP3/WMA/AAC disc, USB, iPod, Bluetooth® audio	Press	Track up/down
	Press and hold	Fast forward/rewind

▶“MODE” switch

Mode	Operation	Function
AM/FM Radio, AUX, DAB	Press	Change audio modes
	Press and hold	Mute
Audio CD, MP3/WMA/AAC disc, USB, iPod, Bluetooth® audio	Press	Change audio modes
	Press and hold	Pause

5. TIPS FOR OPERATING THE AUDIO SYSTEM

1. OPERATING INFORMATION



NOTICE

- To avoid damaging the audio system:
 - Be careful not to spill beverages over the audio system.
 - Do not put anything other than appropriate discs into the CD player slot.

INFORMATION

- The use of a cellular phone inside or near the vehicle may cause a noise from the speakers of the audio system which you are listening to. However, this does not indicate a malfunction.

RADIO RECEPTION

Usually, a problem with radio reception does not mean there is a problem with your radio — it is just the normal result of conditions outside the vehicle.

For example, nearby buildings and terrain can interfere with FM reception. Power lines or telephone wires can interfere with AM signals. And of course, radio signals have a limited range, and the farther you are from a station, the weaker its signal will be. In addition, reception conditions change constantly as your vehicle moves.

Here are some common reception problems that probably do not indicate a problem with your radio.

2

AUDIO SYSTEM

5. TIPS FOR OPERATING THE AUDIO SYSTEM

FM

Fading and drifting stations: Generally, the effective range of FM is about 40 km (25 miles). Once outside this range, you may notice fading and drifting, which increase with the distance from the radio transmitter. They are often accompanied by distortion.

Multi-path: FM signals are reflective, making it possible for two signals to reach your antenna at the same time. If this happens, the signals will cancel each other out, causing a momentary flutter or loss of reception.

Static and fluttering: These occur when signals are blocked by buildings, trees, or other large objects. Increasing the bass level may reduce static and fluttering.

Station swapping: If the FM signal you are listening to is interrupted or weakened, and there is another strong station nearby on the FM band, your radio may tune in the second station until the original signal can be picked up again.

AM

Fading: AM broadcasts are reflected by the upper atmosphere — especially at night. These reflected signals can interfere with those received directly from the radio station, causing the radio station to sound alternately strong and weak.

Station interference: When a reflected signal and a signal received directly from a radio station are very nearly the same frequency, they can interfere with each other, making it difficult to hear the broadcast.

Static: AM is easily affected by external sources of electrical noise, such as high tension power lines, lightning, or electrical motors. This results in static.

iPod

- “Made for iPod”, “Made for iPhone” and “Made for iPad” mean that an electronic accessory has been designed to connect specifically to iPod, iPhone, or iPad, respectively, and has been certified by the developer to meet Apple performance standards.
- Apple is not responsible for the operation of this device or its compliance with safety and regulatory standards. Please note that the use of this accessory with iPod, iPhone, or iPad may affect wireless performance.
- iPad, iPhone, iPod, iPod classic, iPod nano, and iPod touch are trademarks of Apple Inc., registered in the U.S. and other countries. Lightning is a trademark of Apple Inc.
- The Lightning connector works with iPhone 5, iPod touch (5th generation), and iPod nano (7th generation).
- The 30-pin connector works with iPhone 4S, iPhone 4, iPhone 3GS, iPhone 3G, iPhone, iPod touch (1st through 4th generation), iPod classic (except 5th generation), and iPod nano (1st, 3rd, 4th, 5th and 6th generation).
- USB works with iPhone 5, iPhone 4S, iPhone 4, iPhone 3GS, iPhone 3G, iPhone, iPod touch (1st through 5th generation), iPod classic (except 5th generation), and iPod nano (1st, 3rd, 4th, 5th, 6th and 7th generation).

COMPATIBLE MODELS

The following iPod®, iPod nano®, iPod classic®, iPod touch® and iPhone® devices can be used with this system.

Made for

- iPod touch (5th generation)
- iPod touch (4th generation)
- iPod touch (3rd generation)
- iPod touch (2nd generation)
- iPod touch (1st generation)
- iPod classic (except 5th generation)
- iPod nano (7th generation)
- iPod nano (6th generation)
- iPod nano (5th generation)
- iPod nano (4th generation)
- iPod nano (3rd generation)
- iPod nano (1st generation)
- iPhone 5
- iPhone 4S
- iPhone 4
- iPhone 3GS
- iPhone 3G
- iPhone

Depending on differences between models or software versions etc., some models might be incompatible with this system.

5. TIPS FOR OPERATING THE AUDIO SYSTEM

CARING FOR YOUR CD PLAYER AND DISCS

- Extremely high temperatures can keep your CD player from working. On hot days, use air conditioning to cool the vehicle interior before you listen to a disc.
- Bumpy roads or other vibrations may make your CD player skip.
- If moisture gets into your CD player, you may not hear any sound even though your CD player appears to be working. Remove the discs from the CD player and wait until it dries.

⚠ CAUTION

- CD player uses an invisible laser beam which could cause hazardous radiation exposure if directed outside the unit. Be sure to operate the CD player correctly.

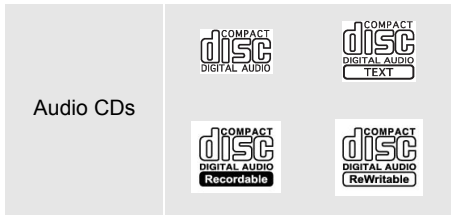

- Use only discs marked as shown above. The following products may not be playable on your CD player.
 - SACDs
 - dts CDs
 - Copy-protected CDs
 - Video CDs

► Special shaped discs

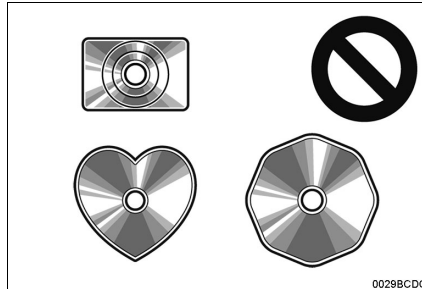

► Transparent/translucent discs

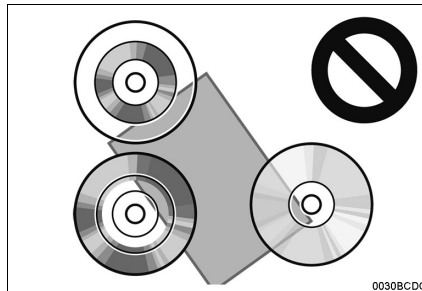

► Low quality discs

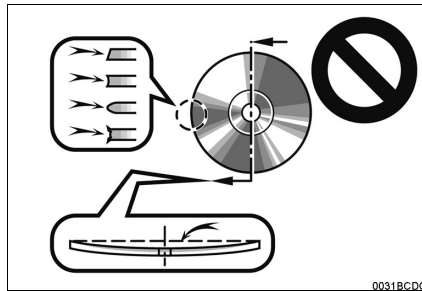

► Labeled discs

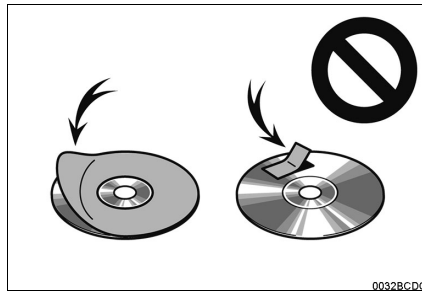

**NOTICE**

- Do not use special shaped, transparent/translucent, low quality or labeled discs such as those shown in the illustrations. The use of such discs may damage the player, or it may be impossible to eject the disc.
- This system is not designed for use of Dual Disc. Do not use Dual Disc because it may cause damage to the player.
- Do not use discs with a protection ring. The use of such discs may damage the player, or it may be impossible to eject the disc.
- Do not use printable discs. The use of such discs may damage the player, or it may be impossible to eject the disc.

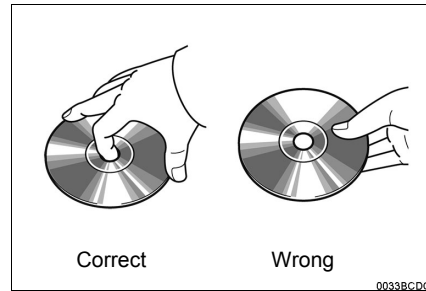

- Handle discs carefully, especially when you are inserting them. Hold them on the edge and do not bend them. Avoid getting fingerprints on them, particularly on the shiny side.
- Dirt, scratches, warping, pin holes, or other disc damage could cause the CD player to skip or to repeat a section of a track. (To see a pin hole, hold the disc up to the light.)
- Remove discs from the CD player when you are not using them. Store them in their plastic cases away from moisture, heat, and direct sunlight.

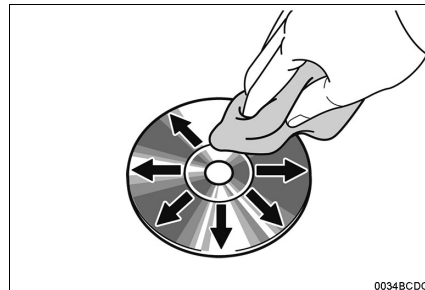

- **To clean a disc:** Wipe it with a soft, lint-free cloth that has been dampened with water. Wipe in a straight line from the centre to the edge of the disc (not in a circle). Do not use a conventional record cleaner or anti-static device.

5. TIPS FOR OPERATING THE AUDIO SYSTEM

FILE INFORMATION

COMPATIBLE USB DEVICES

USB communication formats	USB 2.0 HS (480 Mbps) and FS (12 Mbps)
File formats	FAT 16/32
Correspondence class	Mass storage class

COMPATIBLE COMPRESSED FILES

Item	USB	DISC
Compatible file format (audio)	MP3/WMA/AAC	
Folders in the device	Maximum 3000	Maximum 192
Files in the device	Maximum 9999	Maximum 255
Files per folder	Maximum 255	—

CORRESPONDING SAMPLING FREQUENCY

File type	Frequency (kHz)
MP3 files: MPEG 1 LAYER 3	32/44.1/48
MP3 files: MPEG 2 LSF LAYER 3	16/22.05/24
WMA files: Ver. 7, 8, 9 (9.1/9.2)	32/44.1/48
AAC files: MPEG4/AAC-LC	11.025/12/16/ 22.05/24/32/ 44.1/48

CORRESPONDING BIT RATES

File type	Bit rate (kbps)
MP3 files: MPEG 1 LAYER 3	32 - 320
MP3 files: MPEG 2 LSF LAYER 3	8 - 160
WMA files: Ver. 7, 8	CBR 48 - 192
WMA files: Ver. 9 (9.1/9.2)	CBR 48 - 320
AAC files: MPEG4/AAC-LC	16 - 320

(Variable Bit Rate (VBR) compatible)

- MP3 (MPEG Audio Layer 3), WMA (Windows Media Audio) and AAC (Advanced Audio Coding) are audio compression standards.
- This system can play MP3/WMA/AAC files on CD-R, CD-RW discs and USB memory.
- This system can play disc recordings compatible with ISO 9660 level 1 and level 2 and with the Romeo and Joliet file system.
- When naming an MP3/WMA/AAC file, add an appropriate file extension (.mp3/.wma/.m4a).
- This system plays back files with .mp3/.wma/.m4a file extensions as MP3/WMA/AAC files respectively. To prevent noise and playback errors, use the appropriate file extension.
- This system can play only the first session when using multi-session compatible CDs.
- MP3 files are compatible with the ID3 Tag Ver. 1.0, Ver. 1.1, Ver. 2.2 and Ver. 2.3 formats. This system cannot display disc title, track title and artist name in other formats.
- WMA/AAC files can contain a WMA/AAC tag that is used in the same way as an ID3 tag. WMA/AAC tags carry information such as track title and artist name.
- The emphasis function is available only when playing MP3/WMA files recorded at 32, 44.1 and 48 kHz.
- This system can play back AAC files encoded by iTunes.
- The sound quality of MP3/WMA files generally improves with higher bit rates. In order to achieve a reasonable level of sound quality, discs recorded with a bit rate of at least 128 kbps are recommended.
- M3u playlists are not compatible with the CD player.
- MP3i (MP3 interactive) and MP3PRO formats are not compatible with the audio player.
- The player is compatible with VBR (Variable Bit Rate).
- When playing back files recorded as VBR (Variable Bit Rate) files, the play time will not be correctly displayed if the fast forward or reverse operations are used.
- It is not possible to check folders that do not include MP3/WMA/AAC files.
- MP3/WMA/AAC files in folders up to 8 levels deep can be played. However, the start of playback may be delayed when using discs containing numerous levels of folders. For this reason, we recommend creating discs with no more than 2 levels of folders.

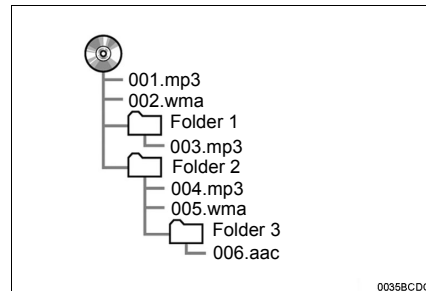

- The play order of the compact disc with the structure shown above is as follows:

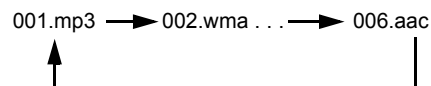

- The order changes depending on the personal computer and MP3/WMA/AAC encoding software you use.

CD-R AND CD-RW DISCS

- CD-R/CD-RW discs that have not been subject to the “finalizing process” (a process that allows discs to be played on a conventional CD player) cannot be played.
- It may not be possible to play CD-R/CD-RW discs recorded on a music CD recorder or a personal computer because of disc characteristics, scratches or dirt on the disc, or dirt, condensation, etc. on the lens of the unit.
- It may not be possible to play discs recorded on a personal computer depending on the application settings and the environment. Record with the correct format. (For details, contact the appropriate application manufacturers of the applications.)
- CD-R/CD-RW discs may be damaged by direct exposure to sunlight, high temperatures or other storage conditions. The unit may be unable to play some damaged discs.
- If you insert a CD-RW disc into the MP3/WMA player, playback will begin more slowly than with a conventional CD or CD-R disc.
- Recordings on CD-R/CD-RW cannot be played using the DDCCD (Double Density CD) system.

TERMS

PACKET WRITE

- This is a general term that describes the process of writing data on-demand to CD-R, etc., in the same way that data is written to floppy or hard discs.

ID3 TAG

- This is a method of embedding track-related information in an MP3 file. This embedded information can include the track title, the artist's name, the album title, the music genre, the year of production, comments, cover art and other data. The contents can be freely edited using software with ID3 tag editing functions. Although the tags are restricted to the number of characters, the information can be viewed when the track is played back.

WMA TAG

- WMA files can contain a WMA tag that is used in the same way as an ID3 tag. WMA tags carry information such as track title, artist name.

ISO 9660 FORMAT

- This is the international standard for the formatting of CD-ROM folders and files. For the ISO 9660 format, there are two levels of regulations.
- Level 1: The file name is in 8.3 format (8 character file names, with a 3 character file extension. File names must be composed of one-byte capital letters and numbers. The “_” symbol may also be included.)
- Level 2: The file name can have up to 31 characters (including the separation mark “.” and file extension). Each folder must contain fewer than 8 hierarchies.

m3u

- Playlists created using “WINAMP” software have a playlist file extension (.m3u).

MP3

- MP3 is an audio compression standard determined by a working group (MPEG) of the ISO (International Standard Organization). MP3 compresses audio data to about 1/10 the size of that on conventional discs.

WMA

- WMA (Windows Media Audio) is an audio compression format developed by Microsoft®. It compresses files into a size smaller than that of MP3 files. The decoding formats for WMA files are Ver. 7, 8, and 9.
- This product is protected by certain intellectual property rights of Microsoft Corporation and third parties. Use or distribution of such technology outside of this product is prohibited without a license from Microsoft or an authorized Microsoft subsidiary and third parties.

AAC

- AAC is short for Advanced Audio Coding and refers to an audio compression technology standard used with MPEG2 and MPEG4.

**1 BASIC INFORMATION
BEFORE OPERATION**

1. QUICK REFERENCE 76

2. HANDS-FREE SYSTEM..... 79

 USING THE PHONE SWITCH/
 MICROPHONE 80

 ABOUT THE PHONE BOOK IN
 THIS SYSTEM 81

 WHEN YOU RELEASE YOUR CAR 81

 CONNECTING A Bluetooth®
 PHONE 82

3. REGISTERING AN ENTRY 83

 REGISTERING A NEW ENTRY 83

 DISPLAYING AND EDITING THE
 ENTRY INFORMATION 85

 SENDING STORED CONTACTS TO
 A USB MEMORY 86

3

Bluetooth® HANDS-FREE SYSTEM

2 PHONE OPERATION

1. CALLING ON A Bluetooth® PHONE.....	87
BY DIAL	87
BY CONTACTS LIST.....	88
BY PHONE BOOK.....	88
BY CALL LISTS	89
CALLING USING A SHORT MESSAGE.....	90
BY POI* CALL.....	90
BY SELECTING SOS SCREEN BUTTON.....	91
2. RECEIVING CALLS ON A Bluetooth® PHONE.....	92
3. TALKING ON A Bluetooth® PHONE.....	93
SENDING TONES	94
DIALING A SECOND NUMBER	95
ADJUSTING THE RECEIVER VOLUME	96

3 SHORT MESSAGE FUNCTION

1. SHORT MESSAGE FUNCTION	97
RECEIVING A SHORT MESSAGE.....	97
CHECKING RECEIVED SHORT MESSAGES.....	97
CHECKING SENT SHORT MESSAGES.....	98
SENDING A NEW SHORT MESSAGE	99

4 WHAT TO DO IF...

1. TROUBLESHOOTING.....	102
--------------------------------	------------

1
2
3
4
5
6
7
8
9

Some of the functions cannot be operated while driving.
*: Point of Interest

1. BASIC INFORMATION BEFORE OPERATION

1. QUICK REFERENCE

■ “Phone” MENU SCREEN

Pressing the  button allows access to the “Phone” menu screen.

Each time the  button is pressed, the screen will change between the “Phone” menu screen and the “Extras”/“Toyota online” menu screen.

When the  button is pressed, the screen that was last displayed will be shown.

Select  to display the “Phone” menu screen.



No.	Function	Page
1	Select to display the "Dial" screen. A call can be made by dialing the number.	87
2	Select to display the "Contacts" screen. An entry from the list of contacts in the "Stored" and "Phone book" screen can be selected and called.	88
3	Select to display the "Call lists" screen. An entry from the missed, received or dial call lists can be selected and called.	89
4	Select to display the "Messages" screen. A list of received and sent short messages and a menu to create new short messages can be displayed.	97
5	Select the corresponding icon to change to the "Dial", "Contacts", "Call lists" or "Messages" screen.	—

1. BASIC INFORMATION BEFORE OPERATION

■ “Dial” SCREEN

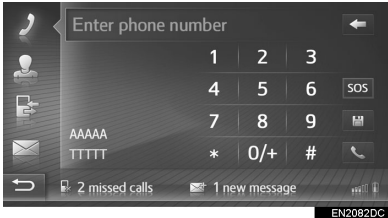

- This screen can be displayed by selecting  on any of the phone screens.

■ “Messages” SCREEN

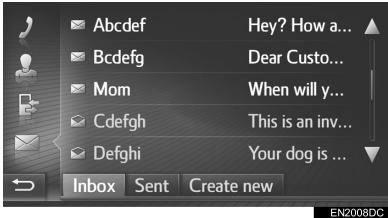

- This screen can be displayed by selecting  on any of the phone screens.

■ “Contacts” SCREEN

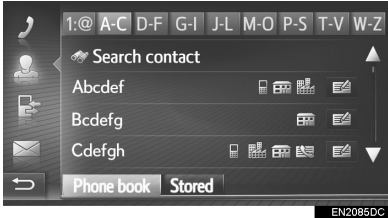

- This screen can be displayed by selecting  on any of the phone screens.

■ “Call lists” SCREEN



- This screen can be displayed by selecting  on any of the phone screens.

1. BASIC INFORMATION BEFORE OPERATION

2. HANDS-FREE SYSTEM

Bluetooth® hands-free system allows you to make or receive a call without taking your hands off the steering wheel by connecting your cellular phone.

This system supports Bluetooth®. Bluetooth® is a wireless data system by which you can call without your cellular phone being connected with a cable or placed on a cradle.

The operating procedure of the system is explained in this section.



CAUTION

- Use a cellular phone or connect the Bluetooth® phone only when safe and legal to do so.
- Your audio unit is fitted with Bluetooth® antennas. People with implantable cardiac pacemakers, cardiac resynchronization therapy-pacemakers or implantable cardioverter defibrillators should maintain a reasonable distance between themselves and the Bluetooth® antennas. The radio waves may affect the operation of such devices.
- Before using Bluetooth® devices, users of any electrical medical device other than implantable cardiac pacemakers, cardiac resynchronization therapy-pacemakers or implantable cardioverter defibrillators should consult the manufacturer of the device for information about its operation under the influence of radio waves. Radio waves could have unexpected effects on the operation of such medical devices.



NOTICE

- Do not leave your cellular phone in the vehicle. The temperature inside may rise to a level that could damage the phone.

INFORMATION

- If your cellular phone does not support Bluetooth®, this system will not function.
- In the following conditions, the system may not function:
 - The cellular phone is turned off.
 - The current position is outside the communication area.
 - The cellular phone is not connected.
 - The cellular phone has a low battery.
- When using Bluetooth® audio and hands-free at the same time, the following problems may occur.
 - The Bluetooth® connection may be cut.
 - Noise may be heard on the Bluetooth® audio playback.

3

Bluetooth® HANDS-FREE SYSTEM

USING THE PHONE SWITCH/ MICROPHONE

► Steering switch

By pressing the phone switch, a call can be received or ended without taking your hands off the steering wheel.

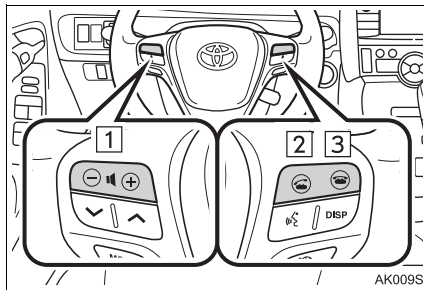

1 Volume control switch

- Press the "+" side to increase the volume.
- Press the "-" side to decrease the volume.

2 Off hook switch

3 On hook switch

► Microphone

The microphone is used when talking on the phone.

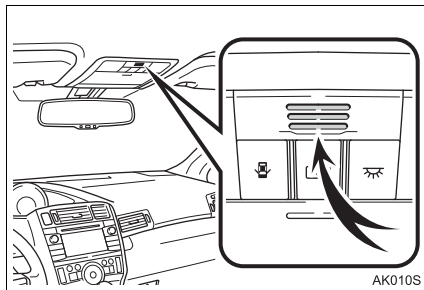

INFORMATION

- The other party's voice will be heard from the front speakers. The audio system will be muted during phone calls.
- Talk alternately with the other party on the phone. If you talk at the same time, your voices may not reach each other. (It is not a malfunction.)
- Keep the volume of receiving voice down. Otherwise, an echo will be heard and receiving voice can be heard outside of the vehicle. When you talk on the phone, speak clearly towards the microphone.
- In the following situations, your voice may not reach the other party.
 - Driving on an unpaved road. (Due to traffic noise.)
 - Driving at high speed.
 - A window is open.
 - Turning the air-conditioning vents towards the microphone.
 - The sound of the air-conditioning fan is loud.
 - There is an effect from the cellular phone network.

ABOUT THE PHONE BOOK IN THIS SYSTEM

- The following data is stored for every registered phone. When another phone is connecting, you cannot read the registered data.
 - Phone book data
 - Call history data

INFORMATION

- When you delete the phone, the above-mentioned data is also deleted.

WHEN YOU RELEASE YOUR CAR

A lot of personal data is registered when you use the Hands-free system. When you release your car, initialize your data. (→P.122)

- You can initialize the following data in the system.
 - Phone book data
 - Call history data
 - Volume setting
 - Bluetooth® setting
 - All telephone settings
 - Short message template

INFORMATION

- Once the data is initialized, all personal data will be erased. Pay due care when initializing the data.

3

Bluetooth® HANDS-FREE SYSTEM

1. BASIC INFORMATION BEFORE OPERATION

CONNECTING A Bluetooth® PHONE

In order to use the hands-free system, it is necessary to pair the phone and connect the phone's profile (HFP) with the system.

Once the profile has been connected, hands-free calls can be made.

If you have not yet connected any Bluetooth® phones with phone profile (HFP), you must first connect your phone with phone profile (HFP) according to the following procedure.

Connect your Bluetooth® phone with phone profile (HFP) after bringing the vehicle to a complete stop.

1 Press the  button.

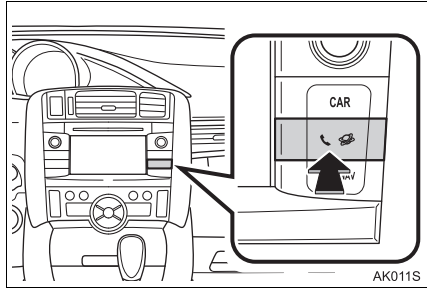

2 Select "Yes".

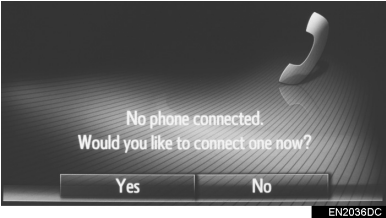

● This screen can be displayed by pressing the  switch on the steering wheel.

3 Follow the steps "PAIRING A Bluetooth® DEVICE". (→P.126, 133)

1. BASIC INFORMATION BEFORE OPERATION

3. REGISTERING AN ENTRY





REGISTERING A NEW ENTRY

Up to 200 numbers can be registered with this system.

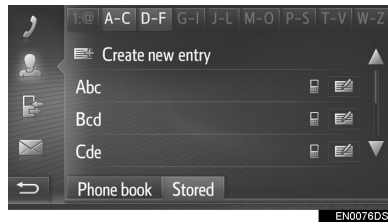
REGISTERING FROM THE "Contacts" SCREEN

- 1 Display the "Phone" menu screen and select **"Contacts"**. (→P.76)
- 2 Select the **"Stored"** tab.
- 3 Select **"Create new entry"**.



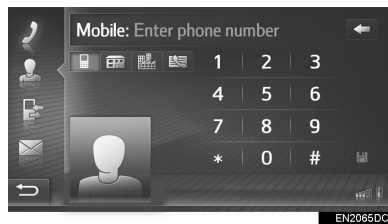

- 4 Select one of 4 phone types (, , , or ) and enter a number.

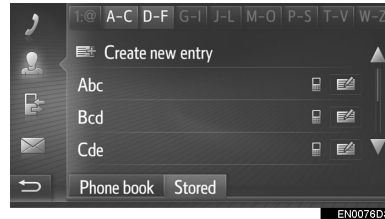

- You can enter one phone number for each phone type.
- 5 Select  .
 - 6 Enter the entry name and then select **"OK"**.

- 7 Check that the entry is registered in the "Stored" list.



- Select  to display and edit the entry information. (→P.85)

REGISTERING FROM THE "Dial" SCREEN

- 1 Display the "Phone" menu screen. (→P.76)
- 2 Select **"Dial"**.
- 3 Enter the numbers.
- 4 Select  .
- 5 Follow the steps "REGISTERING FROM THE "Contacts" SCREEN" from "STEP 6". (→P.83)

INFORMATION

- The phone type is registered as  .

3

Bluetooth® HANDS-FREE SYSTEM

REGISTERING FROM THE “Phone book” SCREEN

- 1 Search the entry by “Phone book”.
(→P.88)
- 2 Select  for desired item.
- 3 Select “Add to stored contacts”.
- 4 Follow the steps “REGISTERING FROM THE “Contacts” SCREEN” from “STEP 6”. (→P.83)

INFORMATION

- The phone type is registered as .
- Navigation system only: If the contact includes an address and a phone number, they will be stored in the “Stored” list on the “My destinations” screen and “Contacts” screen. (→P.83, 210)

REGISTERING FROM THE “Call lists” SCREEN

- 1 Search for the entry by “Call lists”.
(→P.89)
- 2 Select  next to the desired item.
- 3 Follow the steps “REGISTERING FROM THE “Contacts” SCREEN” from “STEP 6”. (→P.83)

INFORMATION

- The phone type is registered as .

REGISTERING FROM AN EXTERNAL DEVICE*

“vCard” formatted data can be transferred from a USB memory to this system. Transferred addresses and numbers will be stored in the “Stored” list on the “My destinations” screen and “Contacts” screen. (→P.83, 210)

*: Navigation system only

DISPLAYING AND EDITING THE ENTRY INFORMATION

Detailed information of entries in the list can be displayed or edited.

- 1 Display the “Phone” menu screen and select “Contacts”. (→P.76)
- 2 Select the “Stored” tab or the “Phone book” tab.
- 3 Select  next to the desired entry.

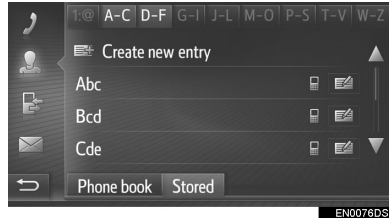

▶ Entry options screen of the “Stored” list

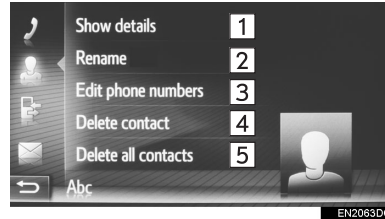

▶ Entry options screen of the “Phone book” list



No.	Function
1	Select to display the details of the entry information. • Select the desired entry to call it.
2	Select to change the entry name. (→ P.86)
3	Select to edit phone numbers. (→ P.86)
4	Select to delete the entry.
5	Select to delete all entries.
6	Select to register the entry in the “Stored” list on the “My destinations” screen (navigation system only) and “Contacts” screen. (→ P.84, 210)

3

Bluetooth® HANDS-FREE SYSTEM

CHANGING THE ENTRY NAME

- 1 Select **"Rename"**.
- 2 Enter the entry name and then select **"OK"**.

EDITING PHONE NUMBERS

- 1 Select **"Edit phone numbers"**.
- 2 Select one of 4 phone types and enter a number and then .

INFORMATION

- If an entry that is transferred from a cellular phone is edited, the change will affect the entry in the "Stored" list on the "My destinations" screen (navigation system only) and "Contacts" screen. (→P.83, 210)

SENDING STORED CONTACTS TO A USB MEMORY*

The entries stored in the "Stored" list on the "My destinations" screen and "Contacts" screen can be transferred to a USB memory. (→P.219)

*: Navigation system only

2. PHONE OPERATION

1. CALLING ON A Bluetooth® PHONE

After a Bluetooth® phone has been connected, a call can be made using the hands-free system.

How to make a call list	Page
By dial	87
By contacts list	88
By phone book	88
By call lists	89
By using a short message	90
By POI call*	90
By selecting SOS screen button*	91
By using the Toyota Eurocare*	242

*: Navigation system only

BY DIAL

- 1 Display the “Phone” menu screen and select “Dial”. (→P.76)
- 2 Enter a phone number.

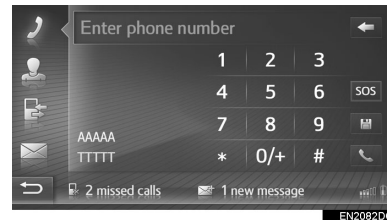

- 3 Select .
- 4 Check that the connecting screen is displayed.



- To cancel a call, select “End call”.

INFORMATION

- Depending on the type of Bluetooth® phone being connected, it may be necessary to perform additional steps on the telephone.
- When “Dial” is selected, the last dialed number will be shown grayed out. Select  to redial the number.
- Navigation system only: Select “0/+” to enter “0”. Select and hold to enter “+” for international calls.
- When the missed calls icon or new short message icon is displayed at the bottom, selecting the icon will display the list.

3

Bluetooth® HANDS-FREE SYSTEM

BY CONTACTS LIST

To use this function, it is necessary to register the entry. (→P.83)

- 1 Display the “Phone” menu screen and select “**Contacts**”. (→P.76)
- 2 Select the “**Stored**” tab.
- 3 Select the desired entry.

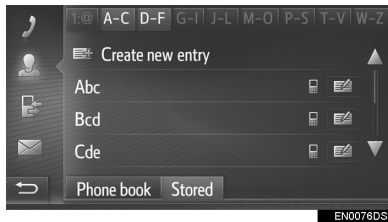

- Select  to display and edit the entry information. (→P.85)
- If there are 2 or more phone numbers, select the desired number in the list.

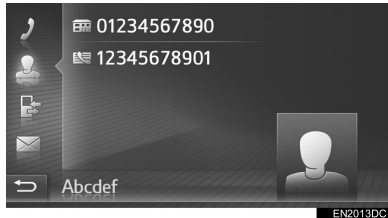

- 4 Check that the connecting screen is displayed.
 - To cancel a call, select “**End call**”.

BY PHONE BOOK

Calls can be made using the phone book data of the connected cellular phone. The phone book changes depending on the phone connected.

- 1 Display the “Phone” menu screen and select “**Contacts**”. (→P.76)
- 2 Select the “**Phone book**” tab.
- 3 Select the desired entry.

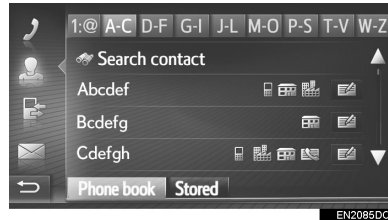

- If there are 2 or more phone numbers, select the desired number in the list.
- “**Search contact**”: Select to search by the contact’s name.

- Select  to display and edit the entry information. (→P.85)
- 4 Check that the connecting screen is displayed.
 - To cancel a call, select “**End call**”.

INFORMATION

- When a phone is connected for the first time, its phone book must be downloaded. If the phone book can not be downloaded, a pop-up window will be displayed.
- If the contact does not have phone number stored, the entry will be dimmed.
- The phone book list can be updated. (→P.148)

BY CALL LISTS

Each call list (missed, received, and dialed) stores up to 15 entries.

- 1 Display the “Phone” menu screen and select “**Call lists**”. (→P.76)
- 2 Select the desired tab.

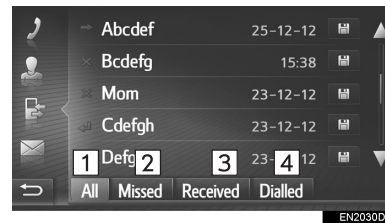

No.	Function
1	Select to display all numbers.
2	Select to display missed calls.
3	Select to display received calls.
4	Select to display dialed numbers.

- The state of a call is shown by the following icons.

 : Missed

 : Received

 : Dialed

3

Bluetooth® HANDS-FREE SYSTEM

2. PHONE OPERATION

- When  is selected, the entry is registered in the “Stored” list on the “Contacts” screen. (→P.84)

- 3 Select the desired entry.
 - 4 Check that the connecting screen is displayed.
- To cancel a call, select “End call”.

CALLING USING A SHORT MESSAGE

Calls can be made to a short message sender’s phone number. (→P.97)

- 1 Select “Call sender”.

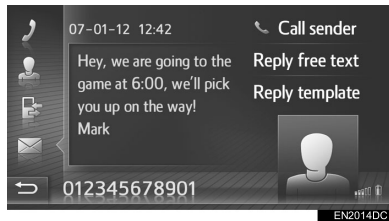

- 2 Check that the connecting screen is displayed.
- To cancel a call, select “End call”.

BY POI CALL *

Calls can be made to a POI when its details are displayed on the screen. (→P.184, 191)

- 1 Select .

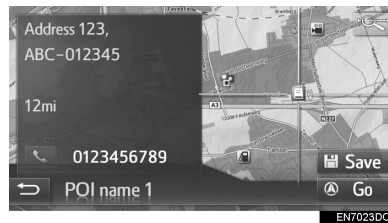

- 2 Check that the connecting screen is displayed.

- To cancel a call, select “End call”.

*: Navigation system only

BY SELECTING SOS SCREEN BUTTON*

112 EMERGENCY CALL SUPPORT

This feature is used to make a 112 emergency call with the select of a button.

This function is not available when the hands-free system is not connected.

This call can only be placed in a country where the 112 emergency call service is available.

- 1 Display the "Phone" menu screen and select "Dial". (→P.76)
- 2 Select "SOS".

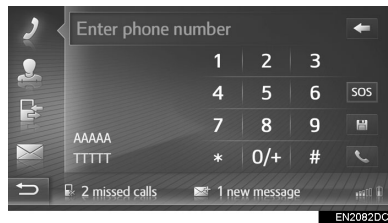

- 3 Select "Yes" when the confirmation screen appears.
- 4 The following screen will be displayed.

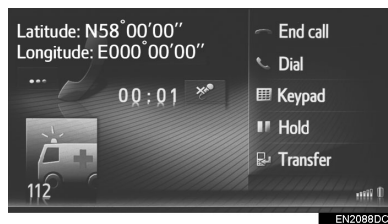

- The geographic coordinates of the current location will be displayed at the top-left corner of the screen.

- When "..." appears on the screen, select to display the following position details.
On freeways: Freeway number, driving direction and next exit.
On other roads: Address information.
Each time "..." is selected, the screen changes between the geographical coordinates and position details.

3

Bluetooth® HANDS-FREE SYSTEM

*: Navigation system only

2. PHONE OPERATION

2. RECEIVING CALLS ON A Bluetooth® PHONE

When a call is received, this screen is displayed and a sound is heard.

- 1 Press the  switch on the steering wheel.

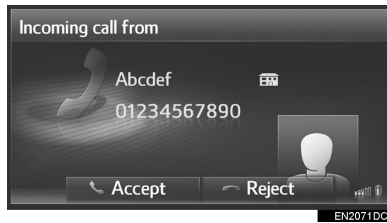

“**Accept**”: Select to talk on the phone.

“**Reject**”: Select to reject the call.

- The layout of the incoming call screen may differ depending on the information available from the connected phone.
- Pressing the  switch on the steering wheel also reject a call.
- Ringtone volume can be adjusted by turning the power/volume knob.

- 2 The following screen is displayed.

► Single call

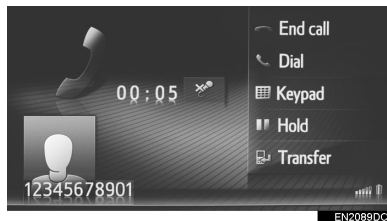

- For details about this screen: →P.93

► Call waiting

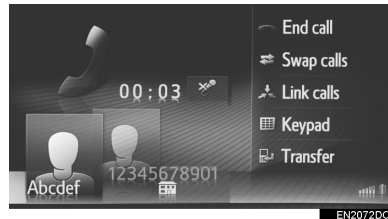

- The first call is put on hold and the information of the party will be dimmed.
- For details about this screen: →P.93

INFORMATION

- During international telephone calls, the other party's name or number may not be displayed correctly depending on the type of cellular phone you have.
- Ringtone and ringtone volume can also be set. (→P.148)
- Navigation system only: The contact's image will be displayed on the screen, if an image from the phone is available. In case no contact's image is available, a dummy image will be displayed.

2. PHONE OPERATION

3. TALKING ON A Bluetooth® PHONE

While you are talking on a Bluetooth® phone, a telephone conversation screen is displayed. The operations outlined below can be performed on this screen.

► Single call



► Call waiting

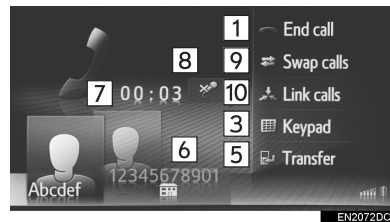

No.	Function
1	Select to hang up the phone. • The  switch on the steering wheel can also be pressed to hang up the phone.
2	Select to dial a second number. (→P.95)
3	Select to send a tone. (→P.94)
4	Select to put a call on hold. To cancel this function, select “Continue” .
5	Select to transfer the call. Select “Transfer” to change from a hands-free call to a cellular phone call. Select “Hands-free” to change from cellular phone call to hands-free call.
6	Displays the other party's information. The information shown here may differ depending on the information available from your phone.
7	Displays a call duration.
8	Select to mute your voice to the other party. The icon will be highlighted during mute mode. To cancel muting your voice, select this icon again.
9	Select to change parties.
10	Select to change to a conference call.

3

Bluetooth® HANDS-FREE SYSTEM

INFORMATION

- When you change from a cellular phone call to a hands-free call, the hands-free screen will be displayed and the call can be operated on the screen.
- Depending on the cellular phone connected, the Bluetooth® connection may be canceled if and when a call is transferred to the cellular phone.
- Transferring methods will be different depending on the type of cellular phone which you have.
- For the operation of the cellular phone, see the manual that comes with your cellular phone.

SENDING TONES

- 1 Select **“Keypad”**.
- 2 Enter the numbers.



- Select  to return the previous screen.

DIALING A SECOND NUMBER

- 1 Select **“Dial”**.
- 2 Select the desired method to call.

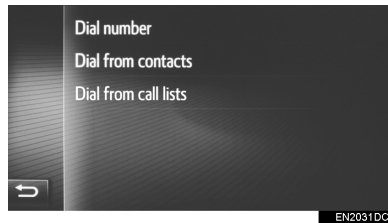

- When **“Dial number”** is selected
- 3 Enter the number and then select



- When **“Dial from contacts”** is selected

- 3 Select the desired list and then select the desired entry.

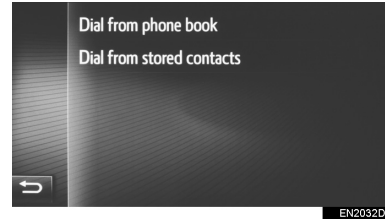

- When **“Dial from call lists”** is selected

- 3 Select the desired list and then select the desired entry.

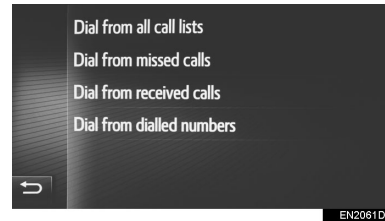

- 4 Check that the connecting screen is displayed.

- To cancel a call, select **“End call”**.

- 5 When a new call has been established, the following screen will be displayed.

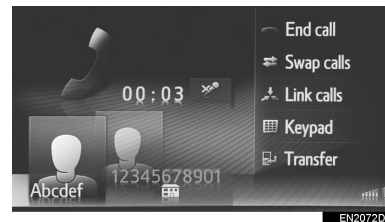

- The first call is put on hold and the information of the party will be dimmed.
- The second call's information is displayed below the first call information.

3

Bluetooth® HANDS-FREE SYSTEM

■ CHANGING PARTIES

1 Select “**Swap calls**”.

- Every time “**Swap calls**” is selected, the party who is on hold will be switched.
- The other party can also be switched by selecting the picture of the desired party (navigation system only) or pressing the  switch on the steering wheel.

■ CHANGING TO A CONFERENCE CALL

1 Select “**Link calls**”.

INFORMATION

- Interrupt call operation may differ depending on your phone company and cellular phone.

ADJUSTING THE RECEIVER VOLUME

1 Turn the power/volume knob to adjust the volume of the other party’s voice.

INFORMATION

- The receiver volume can also be adjusted using the volume control switch on the steering wheel.

3. SHORT MESSAGE FUNCTION

1. SHORT MESSAGE FUNCTION

Received short messages can be forwarded from the connected Bluetooth® phone, enabling checking and replying using this system.

Depending on the type of Bluetooth® phone connected, received short message may not be transferred to the message inbox.

If the phone does not support the short message function, this function cannot be used.

RECEIVING A SHORT MESSAGE

When a new short message is received, a pop-up window is displayed on the screen.

- 1 Select **“Show”** to check a received short message.
- 2 Check that the message is displayed.

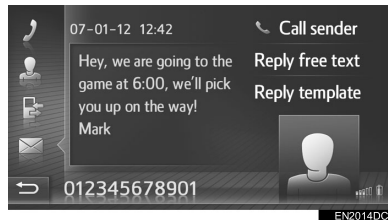

INFORMATION

- This function can be set to on or off. (→P.148)

CHECKING RECEIVED SHORT MESSAGES

- 1 Display the “Phone” menu screen and select **“Messages”**. (→P.76)
- 2 Select the **“Inbox”** tab.
- 3 Select the desired short message.

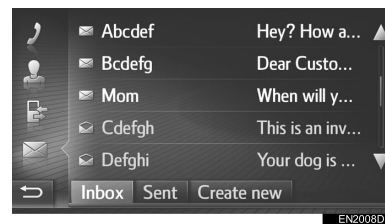

- The state of a message is shown by the following icons.

 : Read message

 : Unread message

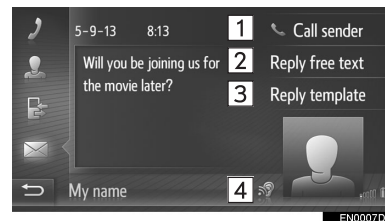

- 4 Check that the message is displayed.



3

Bluetooth® HANDS-FREE SYSTEM

3. SHORT MESSAGE FUNCTION

No.	Function
1	Select to call the sender.
2	Select to reply to the short message by free text.
3	Select to reply to the short message by template.
4*	Select  to have the short message read out. To cancel this function, select  .

*: If equipped

INFORMATION

- While the vehicle is driving the message will be read automatically.

REPLYING TO A SHORT MESSAGE

- 1 Select **“Reply free text”** or **“Reply template”**.
 - When **“Reply template”** is selected, select the desired template.
- 2 Enter the message and then select **“OK”**.
 - The short message will be sent.

INFORMATION

- “Reply free text” function is not available while driving.

CHECKING SENT SHORT MESSAGES

- 1 Display the “Phone” menu screen and select **“Messages”**. (→P.76)
- 2 Select the **“Sent”** tab.
- 3 Select the desired short message.

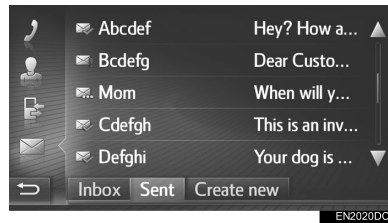

- Navigation system only: The state of a message is shown by the following icons.

 : Sent succeeded

 : Sent failed

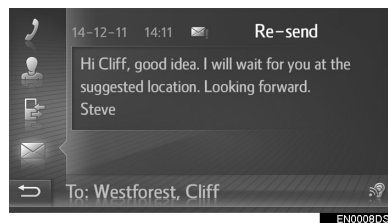

 : Sending

- 4 Check that the message is displayed.



- “Re-send”** (Navigation system only): Select to re-send the message. **“Re-send”** is displayed if sending the text message has failed.

 (If equipped):

When  is selected, the short message is read out. To cancel this function, select .

SENDING A NEW SHORT MESSAGE

- 1 Display the "Phone" menu screen and select "**Messages**". (→P.76)
- 2 Select the "**Create new**" tab.
- 3 Select "**Create message**" or "**Use template**".

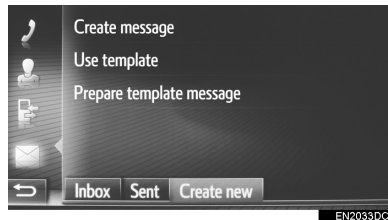

- 4 Enter the message and then select "**OK**". (→P.100)
- 5 Select the desired number/contact to whom the short message should be sent.

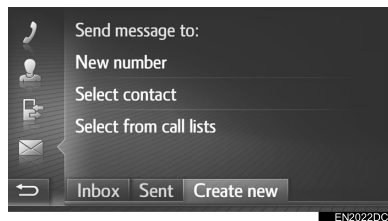

▶ When "**New number**" is selected

- 6 Enter the number and then select "**OK**".

- The short message will be sent.

▶ When "**Select contact**" or "**Select from call lists**" is selected

- 6 Select the desired list.

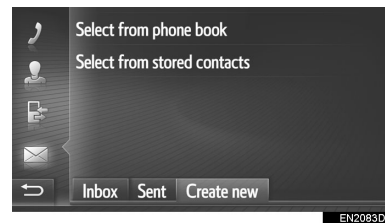

- 7 Select the desired contact.

- If there are 2 or more phone numbers, select the desired number in the list.
- The short message will be sent.

INFORMATION

- The "Create message" and "Prepare template message" functions are not available while driving.

3

Bluetooth® HANDS-FREE SYSTEM

3. SHORT MESSAGE FUNCTION

CREATE A NEW SHORT MESSAGE

■ WHEN “Create message” IS SELECTED

- 1 Enter the message and then select “OK”.



■ WHEN “Use template” IS SELECTED

- 1 Select the desired template.

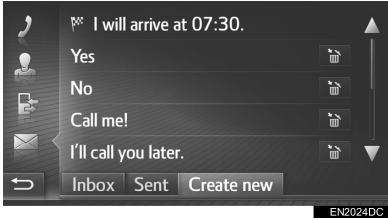

 : Select to delete the template.

- 2 Edit the short message and then select “OK”.



INFORMATION

- 10 messages have already been registered to the message template screen.
- Navigation system only: When route guidance is currently active, “I will arrive at XX:XX.” template is available. (“XX:XX” is the current estimated time of arrival.) This template cannot be deleted.
- The cursor’s position can be moved by selecting the desired location in the enter screen.
- The short messages can contain up to 160 characters. If the entered text exceeds the characters available for one short message, a new short message will begin automatically. This is indicated by a separation line and an icon in the enter field, which is shown as soon as there are only 10 characters left for the short message.



- The number of characters left for the short message is displayed.
- A maximum of 3 short messages can be written in series.
- Entering the text function is not available while driving.

REGISTER NEW TEMPLATES

New templates can be created. Up to 15 templates can be registered.

- 1 Select **“Prepare template message”**.

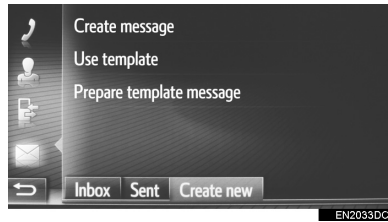

- 2 Enter the message and then select **“OK”**.
 - The message is registered in the template list.

4. WHAT TO DO IF...

1. TROUBLESHOOTING

If there is a problem with the hands-free system or a Bluetooth® device, first check the table below.

► When using the hands-free system with a Bluetooth® device

Symptom	Likely cause	Solution	Page	
			Cellular phone	This system
The hands-free system or Bluetooth® device does not work.	The connected device may not be a compatible Bluetooth® cellular phone.	For a list of specific devices which operation has been confirmed on this system, check with your Toyota dealer.	*	—
	The Bluetooth® version of the connected cellular phone may be older than the specified version.	Use a cellular phone with Bluetooth® version 1.1 or higher (recommended: Ver. 3.0 +EDR or higher).	*	128, 138

► When pairing/connecting a cellular phone

Symptom	Likely cause	Solution	Page	
			Cellular phone	This system
A cellular phone cannot be paired.	An incorrect passcode was entered on the cellular phone.	Enter the correct passcode on the cellular phone.	*	—
	The pairing operation has not been completed on the cellular phone side.	Complete the pairing operation on the cellular phone (approve pairing on the telephone).	*	—
	Old pairing information remains on either this system or the cellular phone.	Delete the existing pairing information from both this system and the cellular phone, then pair the cellular phone you wish to connect to this system.	*	130, 140

3

Bluetooth® HANDS-FREE SYSTEM

4. WHAT TO DO IF...

Symptom	Likely cause	Solution	Page	
			Cellular phone	This system
A Bluetooth® connection cannot be made.	Another Bluetooth® device is already connected.	Manually connect the cellular phone you wish to use to this system.	—	130, 140
	Bluetooth® function is not enabled on the cellular phone.	Enable the Bluetooth® function on the cellular phone.	*	—
	Automatic Bluetooth® connection on this system is set to off.	<p>▶ Vehicles without smart entry & start system</p> <p>Set automatic Bluetooth® connection on this system to on when the engine switch is turned to the “ACC” or “ON” position.</p> <p>▶ Vehicles with smart entry & start system</p> <p>Set automatic Bluetooth® connection on this system to on when the engine switch is turned to ACCESSORY or IGNITION ON mode.</p>	—	125, 133
	Old registration information remains on either this system or the cellular phone.	Delete the existing registration information from both this system and the cellular phone, then register the cellular phone you wish to connect to this system.	*	130, 140

▶ When making/receiving a call

Symptom	Likely cause	Solution	Page	
			Cellular phone	This system
A call cannot be made/received.	Your vehicle is in a no service area.	Move to an area where the service signal appears on the display.	—	—

3

▶ When using the phone book

Symptom	Likely cause	Solution	Page	
			Cellular phone	This system
Phone book data cannot be transferred manually/automatically.	The profile version of the connected cellular phone may not be compatible with transferring phone book data.	For a list of specific devices which operation has been confirmed on this system, check with your Toyota dealer.	*	—
	Transfer operation on the cellular phone has not completed.	Complete transfer operation on the cellular phone (approve transfer operation on the phone).	*	—

Bluetooth® HANDS-FREE SYSTEM

4. WHAT TO DO IF...

► When using the Bluetooth® message function

Symptom	Likely cause	Solution	Page	
			Cellular phone	This system
Messages cannot be viewed.	Message transfer is not enabled on the cellular phone.	Enable message transfer on the cellular phone (approve message transfer on the telephone).	*	—
New message notifications are not displayed.	Notification of SMS/E-mail reception on this system is set to off.	Set notification of SMS/E-mail reception on this system to on.	*	148

► In other situations

Symptom	Likely cause	Solution	Page	
			Cellular phone	This system
Even though all conceivable measures have been taken, the symptom status does not change.	The cellular phone is not close enough to this system.	Bring the cellular phone closer to this system.	—	—
	Radio interference has occurred.	Turn off Wi-Fi® devices or other devices that may emit radio waves.	—	—
	The cellular phone is the most likely cause of the symptom.	Turn the cellular phone off, remove and reinstall the battery pack, and then restart the cellular phone.	*	—
		Enable the cellular phone's Bluetooth® connection.	*	—
		Disable the Wi-Fi® connection of the cellular phone.	*	—
		Stop the cellular phone's security software and close all applications.	*	—
		Before using an application installed on the cellular phone, carefully check its source and how its operation might affect this system.	*	—

3

Bluetooth® HANDS-FREE SYSTEM

*: For details, refer to the owner's manual that came with the cellular phone.

4. WHAT TO DO IF...

4

SPEECH COMMAND SYSTEM

1 SPEECH COMMAND SYSTEM OPERATION

1. SPEECH COMMAND SYSTEM	110
USING THE SPEECH COMMAND SYSTEM	110
SPEECH COMMAND SYSTEM OPERATION.....	111

1

2

3

4

5

6

7

8

9

1. SPEECH COMMAND SYSTEM OPERATION

1. SPEECH COMMAND SYSTEM*

The speech command system enables the navigation, audio and hands-free systems to be operated using speech commands.

INFORMATION

- Voice recognition language can be changed. →P.120
- This function is compatible with the following languages:
 - English
 - French
 - German
 - Spanish
 - Italian
 - Dutch
 - Portuguese
 - Polish
 - Czech
 - Danish
 - Swedish
 - Finnish
 - Russian
 - Greek
 - Turkish

USING THE SPEECH COMMAND SYSTEM

STEERING SWITCHES FOR THE SPEECH COMMAND SYSTEM

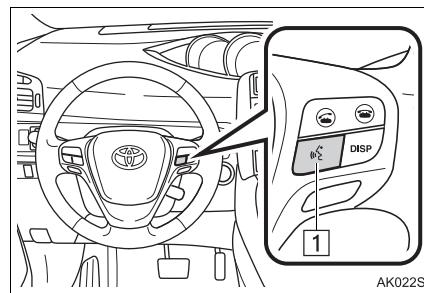

1 Talk switch

- Press the talk switch to start the speech command system.
- Press and hold the talk switch to cancel the speech command system.

*: If equipped

MICROPHONE

It is unnecessary to speak directly into the microphone when giving a command.

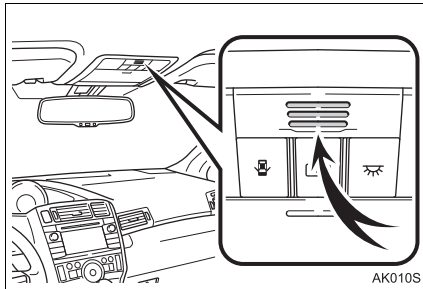

INFORMATION

- Wait for the confirmation beep before speaking a command.
- Speech commands may not be recognized if:
 - Spoken too quickly.
 - Spoken at a low or high volume.
 - The windows are open.
 - Passengers are talking while speech commands are spoken.
 - The air conditioning speed is set high.
 - The air conditioning vents are turned towards the microphone.
- In the following conditions, the system may not recognize the command properly and using speech commands may not be possible:
 - The command is incorrect or unclear. Note that certain words, accents or speech patterns may be difficult for the system to recognize.
 - There is excessive background noise, such as wind noise.

SPEECH COMMAND SYSTEM OPERATION

1 Press the talk switch.

- The speech command system is activated.

- Press the talk switch to stop the currently played prompt and skip to the next dialog step.
- In case of an activated speech recognizer waiting for input, press the talk switch to restart the speech recognizer. (The recognizer drops the previous input and waits for new input from the user.)

2 After a beep sounds, say the desired command or select the desired command.



 : This icon will be displayed if the user can speak a command.

1. SPEECH COMMAND SYSTEM OPERATION

■ DISPLAYING THE COMMAND LIST SCREEN

- 1 Say **“More commands”** or select **“More commands”** on the speech command main menu screen.
- 2 Say the desired command or select the desired command.

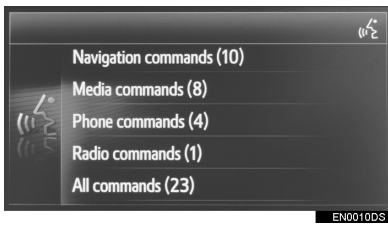

- 3 Say the desired command or select the desired command.

▶ Navigation commands

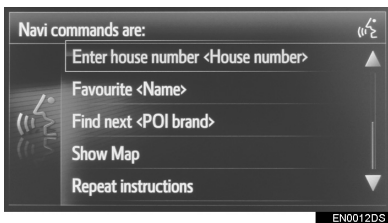

▶ Media commands

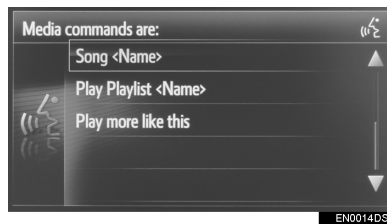
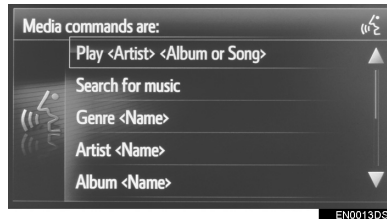

▶ Phone commands

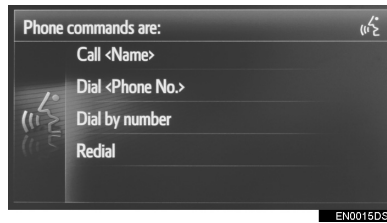

▶ Radio commands

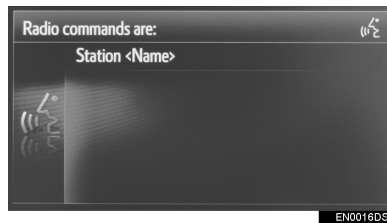

- The command list is read out and the corresponding command is highlighted. To cancel this function, press the talk switch.

5

VEHICLE INFORMATION

1 VEHICLE INFORMATION

- 1. QUICK REFERENCE 114
- 2. FUEL CONSUMPTION 115
 - TRIP INFORMATION 115
 - PAST RECORD 115

1
2
3
4
5
6
7
8
9

1. VEHICLE INFORMATION

1. QUICK REFERENCE

Fuel consumption information can be displayed. To access the vehicle information system, press the “**CAR**” button.

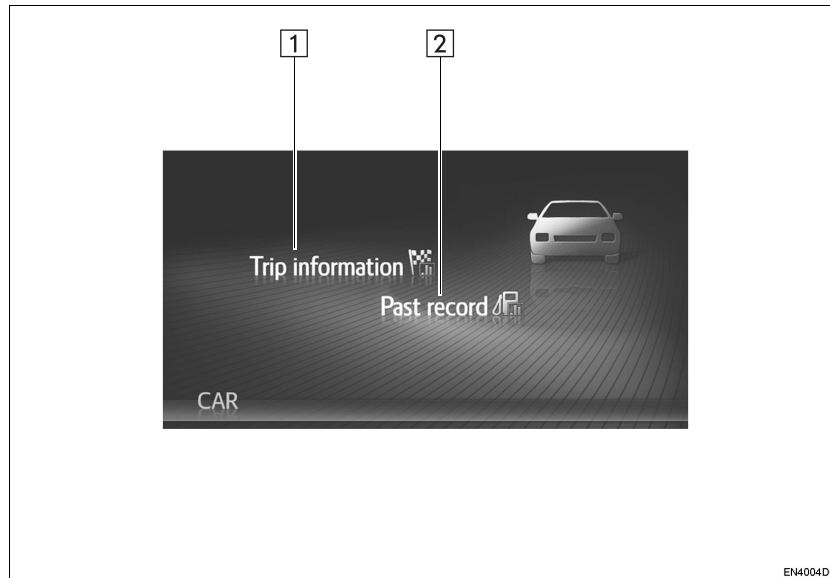

No.	Function	Page
1	Displays the “Trip information” screen	115
2	Displays the “Past record” screen	115

1. VEHICLE INFORMATION

2. FUEL CONSUMPTION

TRIP INFORMATION

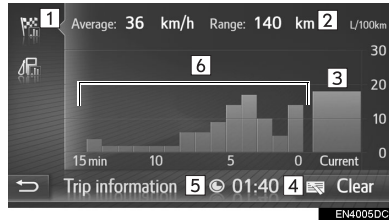

No.	Information/Function
1	Average speed
2	Cruising range
3	Current fuel consumption per minute
4	Select to delete trip information data.
5	Elapsed time
6	Previous fuel consumption per minute

INFORMATION

- The trip information display indicates general driving conditions. Accuracy varies with driving habits and road conditions.
- The image is an example only, and may vary slightly from actual conditions.

PAST RECORD

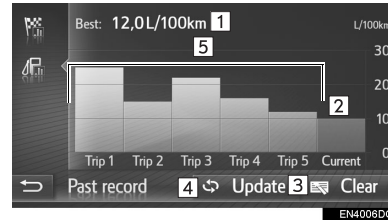

No.	Information/Function
1	Best recorded fuel economy
2	Current fuel economy
3	Select to delete past record data.
4	Select to update the average fuel consumption data.*
5	Previous fuel economy record

*: The average fuel consumption displayed on the multi-information display will also be updated.

INFORMATION

- The image is an example only, and may vary slightly from actual conditions.

5

VEHICLE INFORMATION

1. VEHICLE INFORMATION

6

SETUP

1 SETUP OPERATION

1. QUICK REFERENCE	118
2. GENERAL SETTINGS.....	120
GENERAL SETTINGS SCREEN	120
3. DISPLAY SETTINGS.....	123
4. Bluetooth® SETTINGS	125
Bluetooth® FUNCTION ON/OFF	125
PAIRING A Bluetooth® DEVICE	126
PAIRED DEVICE LIST	130
EDITING THE SYSTEM NAME	131
SETTING PIN.....	131
5. CONNECTIVITY SETTINGS	132
Bluetooth® SETTINGS	132
Wi-Fi® SETTINGS.....	142
QUICK SETUP OF AN INTERNET CONNECTION.....	145
TOYOTA WEB ACCOUNT SETTINGS.....	146
6. TELEPHONE SETTINGS	148
7. AUDIO SETTINGS.....	149
8. VEHICLE SETTINGS.....	151

1
2
3
4
5
6
7
8
9

Some of the functions cannot be operated while driving.

1. SETUP OPERATION

1. QUICK REFERENCE

To customise the function settings, press the “**SETUP**” button.

■ “Setup” SCREEN

► Multimedia system

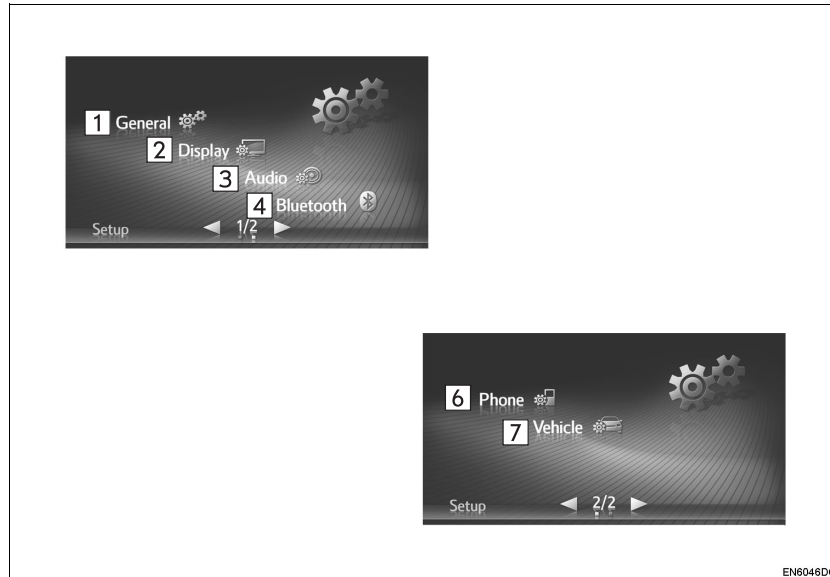

► Navigation system



No.	Function	Page
1	Select to set language, operation sound, etc.	120
2	Select to adjust the contrast and brightness of the screens, turn the screen off, etc.	123
3	Select to adjust sound.	149
4	Select to connect to Bluetooth® devices. Settings are available for Bluetooth® phones and Bluetooth® audio devices.	125
5	Select to setup connections. Settings are available for Bluetooth® devices, Wi-Fi® connections, internet connection methods and Toyota web account.	132
6	Select to adjust phone sound, set a phone book, etc.	148
7	Select to customise the vehicle.	151

1. SETUP OPERATION

2. GENERAL SETTINGS

Settings are available for language selection, operation sounds, etc.

1 Display the "Setup" screen. (→P.118)

2 Select "General".

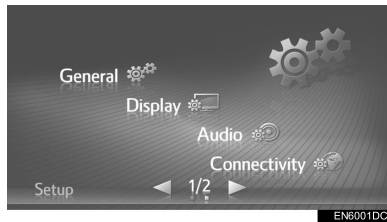

3 Select items to be set.

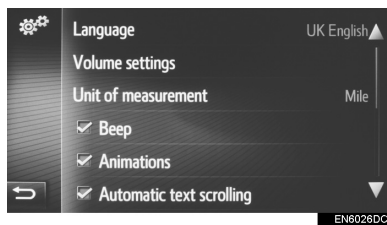

GENERAL SETTINGS SCREEN

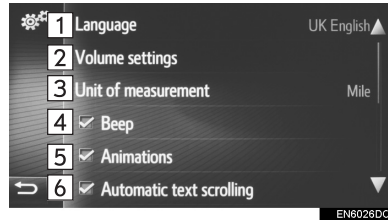

No.	Function
1	Select to change the language.
2	Select to set the volume for the phone/navigation. (→P.122)
3 ^{*1}	Select to change the unit of measure for distance.
4	Select to set the sounds beeps on/off.
5 ^{*2}	Select to set animations on/off.
6	Select to set the automatic text scrolling on/off. This function is not available while driving.
7 ^{*1}	The entries stored in the "Stored" list on the "My destinations" screen and "Contacts" screen (→P.83, 210) can be transferred to a USB memory. (→P.219)
8 ^{*1}	"vCard" formatted data can be transferred from a USB memory to this system. Transferred addresses and numbers will be stored in the "Stored" list on the "My destinations" screen and "Contacts" screen. (→P.220)
9	Select to delete all personal data stored in this system. (→P.122)
10	<p>▶ Multimedia system Select to display the system information.</p> <p>▶ Navigation system Select to display the system information. Select the "Audio information" on the screen to switch the second page.</p>

No.	Function
11	Select to display the open source information. Notices related to third party software used in this product are enlisted. (This includes instructions for obtaining such software, where applicable.)

*1: Navigation system only
*2: Multimedia system only

INFORMATION

- The current setting of each item is displayed on its right.

VOLUME SETTINGS

Volume is shown numerically for each of the different functions.

- 1 Display the general settings screen. (→P.120)
- 2 Select “**Volume settings**”.
- 3 Select “+” or “-” to adjust the a volume.

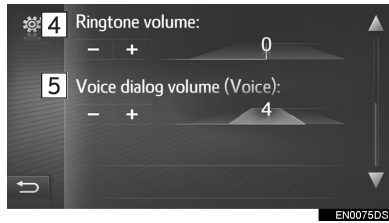
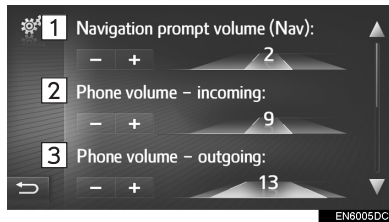

No.	Item
1*1	Navigation prompt volume
2	Reception volume for phone calls
3	Sending volume for phone calls
4	Ringtone volume
5*2	Voice recognition dialog volume

*1: Navigation system only
 *2: If equipped

DELETE ALL PERSONAL DATA

- 1 Display the general settings screen. (→P.120)
 - 2 Select “**Delete all personal data**”.
 - 3 Select “**Yes**” when the confirmation screen appears.
- Registered or changed personal settings will be deleted or returned to their default conditions.

1. SETUP OPERATION

3. DISPLAY SETTINGS

The contrast and brightness of the screen display and the image of the camera display can be adjusted. The screen can also be turned off, and/or changed to either day or night mode.

- 1 Display the "Setup" screen. (→P.118)
- 2 Select "Display".

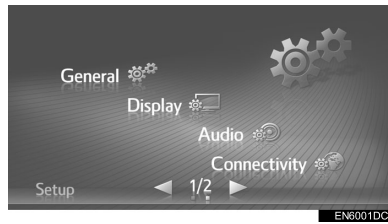

- 3 Select items to be set.

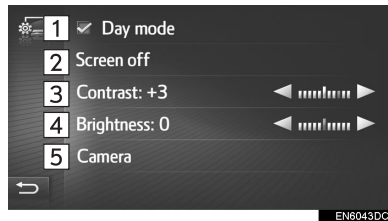

No.	Function	Page
1	Select to set day mode on/off.	124
2	Select to turn the screen off. To turn it on, press any button on the audio panel.	—
3	Select ◀ or ▶ to adjust the contrast of display. <ul style="list-style-type: none"> • ▶: Increases the contrast of the screen • ◀: Decreases the contrast of the screen 	—
4	Select ◀ or ▶ to adjust the brightness of display. <ul style="list-style-type: none"> • ▶: Brightens the screen • ◀: Darkens the screen 	—
5	Select to adjust the camera display.	124

INFORMATION

- Contrast and brightness can be adjusted by touching and dragging the marker on the screen with your finger or touching the desired position on the scale.

6

SETUP

1. SETUP OPERATION

CHANGING BETWEEN DAY AND NIGHT MODE

Depending on the position of the headlight switch, the screen changes to day or night mode. This feature is available when the headlight is switched on.

- 1 Display the display settings screen. (→P.123)
- 2 Select “Day mode”.

INFORMATION

- If the screen is set to day mode with the headlight switch turned on, this condition is memorized even when the engine switch is in the following status.
 - ▶ Vehicles without a smart entry & start system
The engine switch is turned to the “LOCK” position.
 - ▶ Vehicles with a smart entry & start system
The engine switch is turned off.

ADJUSTING THE CAMERA DISPLAY

The contrast and brightness of the camera display can be adjusted.

- 1 Display the display settings screen. (→P.123)
- 2 Select “Camera”.
- 3 Select ◀ or ▶ to adjust the contrast or brightness.

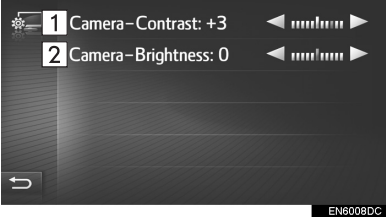

No.	Function	
1	Contrast	▶: Increases the contrast of the screen
		◀: Decreases the contrast of the screen
2	Bright-ness	▶: Brightens the screen
		◀: Darkens the screen

INFORMATION

- Contrast and brightness can be adjusted by touching and dragging the marker on the screen with your finger or touching the desired position on the scale.

1. SETUP OPERATION

4. Bluetooth® SETTINGS

- 1 Display the “Setup” screen. (→P.118)
- 2 Select “**Bluetooth***”.
- 3 The following screen will be displayed.

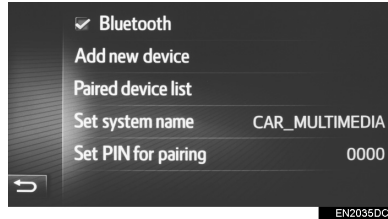

Function	Page
Bluetooth® function on/off	125
Pairing a Bluetooth® device	126
Paired device list	130
Editing the system name	131
Setting PIN	131

Bluetooth® FUNCTION ON/ OFF

- 1 Display the Bluetooth® settings screen. (→P.125)

- 2 Select “**Bluetooth***”.

When “**Bluetooth***” is on:

- ▶ Vehicles without smart entry & start system

The Bluetooth® device is automatically connected when the engine switch is turned to the “ACC” or “ON” position.

- ▶ Vehicles with smart entry & start system

The Bluetooth® device is automatically connected when the engine switch is turned to ACCESSORY or IGNITION ON mode.

When “**Bluetooth***” is off:

The Bluetooth® device is disconnected, and the system will not connect to it next time.

- Even if the Bluetooth® function is set to off, it will turn on automatically when a phone or other Bluetooth® device is connected.

*: Bluetooth is a registered trademark of Bluetooth SIG, Inc.

1. SETUP OPERATION

PAIRING A Bluetooth® DEVICE

Up to 4 Bluetooth® devices can be paired. A paired device can be connected to any of its supported profiles such as phone (HFP), music (A2DP).

ADDING A NEW DEVICE

- 1 Display the Bluetooth® settings screen. (→P.125)
- 2 Select “Add new device”.
 - ▶ When another Bluetooth® device is connected
 - To disconnect the Bluetooth® device, select “YES”.
 - ▶ When 4 Bluetooth® devices have already been paired
 - A paired device needs to be replaced. Select “OK”, and select the device to be replaced.
- 3 When this screen is displayed, search for the device on the screen of your Bluetooth® device.

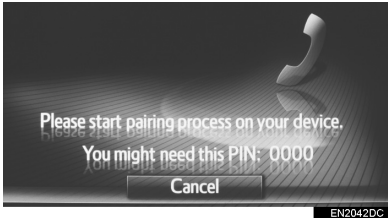

- To cancel the registration, select “Cancel”.

- 4 Pairing the Bluetooth® device using your Bluetooth® device.
 - A PIN code is not required for SSP (Secure Simple Pairing) compatible Bluetooth® devices. Depending on the type of Bluetooth® device being connected a message confirming registration may be displayed on the Bluetooth® device’s screen. Respond and operate the Bluetooth® device according to the confirmation message.

- 5 Check that the following screen is displayed.

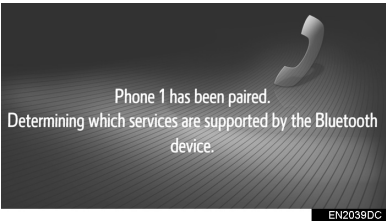

- ▶ If the automatic connection failed, the following screen will be displayed. Select the desired profile to be connected.

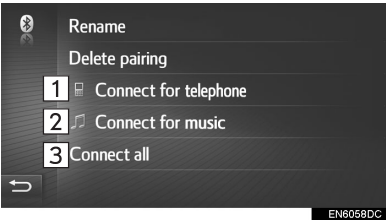

No.	Function	Page
1	Select to connect the phone profile.	130
2	Select to connect the music profile.	130
3	Select to connect all profiles.	130

- Once you have connected the Bluetooth® device, it is automatically connected whenever the engine switch is in the following status.

▶ Vehicles without smart entry & start system

The engine switch is turned to the “ACC” or “ON” position.

▶ Vehicles with smart entry & start system

The engine switch is turned to ACCESSORY or IGNITION ON mode.

INFORMATION

- For details on device detection and the operation of your Bluetooth® device, see the manual that comes with the Bluetooth® device.

RECONNECTING Bluetooth® DEVICE

If a Bluetooth® device is disconnected due to poor reception from the Bluetooth® network when the engine switch is in the following status, the system will automatically reconnect the Bluetooth® device.

▶ Vehicles without smart entry & start system

The engine switch is turned to the “ACC” or “ON” position.

▶ Vehicles with smart entry & start system

The engine switch is turned to ACCESSORY or IGNITION ON mode.

- If the Bluetooth® device is disconnected on purpose, such as it was turned off, this does not happen. Reconnect it manually using either of the following methods:
 - Select a Bluetooth® device again. (→P.130)
 - Connect the audio profile/phone profile. (→P.130)

PROFILES

This system supports the following services.

Bluetooth® device	Specification	Function	Requirements	Recommendations
Bluetooth® Phone/ Bluetooth® Audio Player	Bluetooth® Specification	Registering a Bluetooth® device	Ver. 1.1	Ver. 3.0 +EDR
Bluetooth® device	Profile	Function	Requirements	Recommendations
Bluetooth® Phone	HFP (Hands-Free Profile)	Hands-free system	Ver. 1.0	Ver. 1.6
	PBAP (Phone Book Access Profile)	Transferring the contacts	Ver. 1.0	Ver. 1.1
	MAP (Message Access Profile)	Bluetooth® phone message	Ver. 1.0	—
Bluetooth® Audio Player	A2DP (Advanced Audio Distribution Profile)	Bluetooth® audio system	Ver. 1.0	Ver. 1.2
	AVRCP (Audio/Video Remote Control Profile)		Ver. 1.0	Ver. 1.4

INFORMATION

- If your cellular phone does not support HFP, registering the Bluetooth® phone or using PBAP or MAP profiles individually will not be possible.
- If the connected Bluetooth® device version is older than recommended or incompatible, the Bluetooth® device function may not work properly.



Bluetooth is a registered trademark of Bluetooth SIG, Inc.

STATUS DISPLAY

The condition of the Bluetooth® connection, as well as the level of reception and the amount of device battery charge left, are displayed on the status bar.

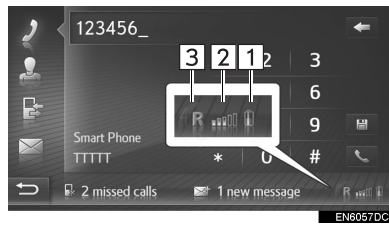

INFORMATION

- An antenna for the Bluetooth® connection is built into the instrument panel. The system may not function when you use the Bluetooth® device in the following conditions and places:
 - When the device is obstructed by certain objects (such as when it is behind the seat or in the glove box and console box).
 - When the device touches or is covered with metal materials.

No.	Function
1	<p>Displays the charge level of the device's battery</p> <ul style="list-style-type: none"> • The amount displayed does not always correspond with the amount displayed on the device. The amount of battery charge left may not be displayed depending on the device. This system does not have a charging function. • If this information is not available from the connected device, the icon will be shown with a question mark.
2	<p>Displays the level of reception</p> <ul style="list-style-type: none"> • The level of reception does not always correspond with the level displayed on the device. • The level of reception may not be displayed depending on the device. • If this information is not available from the connected device, the icon will be shown with a question mark.
3	<p>"R" is displayed when receiving in a roaming area.</p> <ul style="list-style-type: none"> • The receiving area may not be displayed depending on the phone.

1. SETUP OPERATION

PAIRED DEVICE LIST

Each profile connection status can be changed from the "Paired device list".

- 1 Display the Bluetooth® settings screen. (→P.125)
- 2 Select "Paired device list".
- 3 Select the desired device.

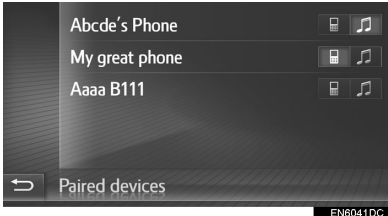

- Dimmed icons can be selected to connect to the function directly.
- The tone of the icons show which profiles the device supports. (Dimmed icons are not available.)
- The device's currently connected profiles are highlighted.

- 4 Check that the following screen is displayed.

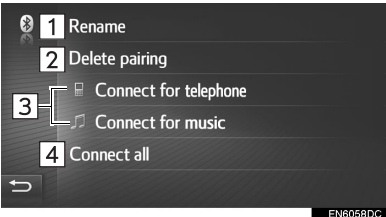

No.	Function	Page
1	Select to change the device name.	130
2	Select to delete the paired device.	130
3	Select to connect/disconnect individually a paired device's profiles.	—
4	<ul style="list-style-type: none"> ▶ When "Connect all" displayed <ul style="list-style-type: none"> • Select to connect all supported profiles. ▶ When "Disconnect all" displayed <ul style="list-style-type: none"> • Select to disconnect all supported profiles. 	—

CHANGING THE DEVICE NAME

- 1 Select "Rename".
- 2 Enter the device name and then select "OK".

DELETING A PAIRED DEVICE

- 1 Select "Delete pairing".
- 2 Select "Yes" when the confirmation screen appears.

EDITING THE SYSTEM NAME

- 1 Display the Bluetooth® settings screen. (→P.125)
- 2 Select **“Set system name”**.
- 3 Enter a name and then select **“OK”**.

SETTING PIN

- 1 Display the Bluetooth® settings screen. (→P.125)
 - 2 Select **“Set PIN for pairing”**.
 - 3 Enter the desired number and then select **“OK”**.
- A PIN code must be 4 digits.

1. SETUP OPERATION

5. CONNECTIVITY SETTINGS*

Settings are available for Bluetooth® devices, Wi-Fi® connections, internet connection methods and Toyota web account.

- 1 Display the “Setup” screen. (→P.118)
- 2 Select “Connectivity”.

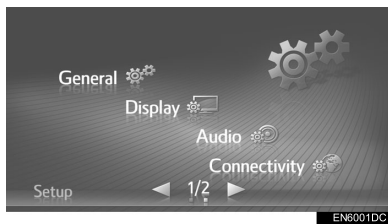

- 3 Select items to be set.

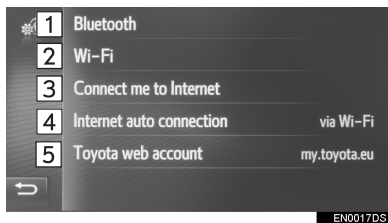

No.	Function	Page
1	Select to display a sub-menu for Bluetooth® where you can connect phone, audio devices and internet devices via Bluetooth®.	132
2*	Select to display a sub-menu for Wi-Fi® where you can connect internet devices via Wi-Fi®.	142
3	Select to search for available internet connection methods.	145
4	Enable to automatically connect to internet.	—

No.	Function	Page
5	Select to add or change your Toyota web account.	146

*: If equipped

Bluetooth® SETTINGS

- 1 Display the connectivity settings screen. (→P.132)
- 2 Select “Bluetooth”.
- 3 Select items to be set.

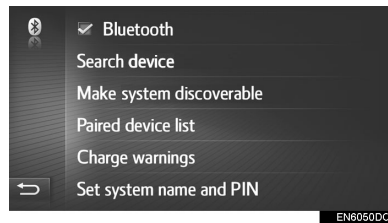

Function	Page
Bluetooth® function on/off	133
Pairing a Bluetooth® device	133
Paired device list	140
Setting charge warnings	141
Setting the system name and PIN	141

*: Bluetooth is a registered trademark of Bluetooth SIG, Inc.

*: Navigation system only

Bluetooth® FUNCTION ON/OFF**1** Select “**Bluetooth***”.

When “**Bluetooth***” is on:

- ▶ Vehicles without smart entry & start system

The Bluetooth® device is automatically connected when the engine switch is turned to the “ACC” or “ON” position.

- ▶ Vehicles with smart entry & start system

The Bluetooth® device is automatically connected when the engine switch is turned to ACCESSORY or IGNITION ON mode.

When “**Bluetooth***” is off:

The Bluetooth® device is disconnected, and the system will not connect to it next time.

- Even if the Bluetooth® function is set to off, it will turn on automatically when a phone or other Bluetooth® device is connected.

*: Bluetooth is a registered trademark of Bluetooth SIG, Inc.

PAIRING A Bluetooth® DEVICE

Up to 4 Bluetooth® devices can be paired. A paired device can be connected to any of its supported profiles such as phone (HFP), music (A2DP) and/or internet (DUN/PAN).

PAIRING FROM THE SYSTEM**1** Select “**Search device**”.

- ▶ When another Bluetooth® device is connected

- To disconnect the Bluetooth® device, select “**YES**”.

- ▶ When 4 Bluetooth® devices have already been paired

- A paired device needs to be replaced. Select “**OK**”, and select the device to be replaced.

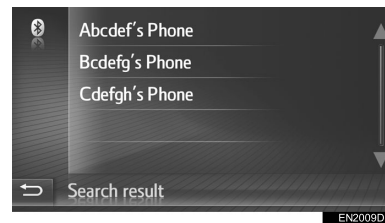
2 Select the desired device.

- Connectable Bluetooth® devices will be displayed in the list.

6

SETUP

1. SETUP OPERATION

3 Confirm the PIN.

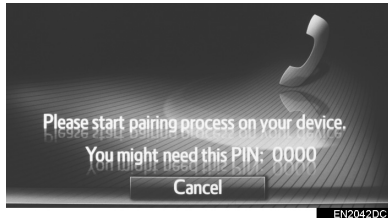

- A PIN code is not required for SSP (Secure Simple Pairing) compatible Bluetooth® devices. Depending on the type of Bluetooth® device being connected a message confirming registration may be displayed on the Bluetooth® device's screen. Respond and operate the Bluetooth® device according to the confirmation message.

4 Check that the following screen is displayed.

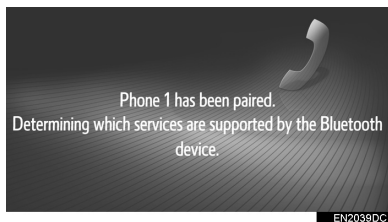

- The system waits for connection requests coming from the paired device. All requested profiles are connected automatically.
- Internet profile is not connected automatically. For details on connecting internet profile (→P.136).

▶ If the automatic connection failed, the following screen will be displayed. Select the desired profile to be connected.

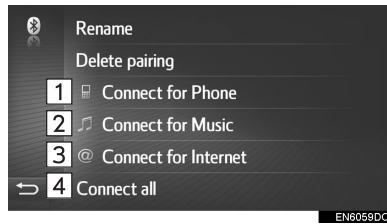

No.	Function	Page
1	Select to connect the phone profile.	140
2	Select to connect the music profile.	140
3	Select to connect the internet profile.	136, 140
4	Select to connect all profiles.	140

- Once you have connected the Bluetooth® device, it is automatically connected whenever the engine switch is in the following status.

▶ Vehicles without smart entry & start system

The engine switch is turned to the “ACC” or “ON” position.

▶ Vehicles with smart entry & start system
The engine switch is turned to ACCESSORY or IGNITION ON mode.

INFORMATION

- For details on device detection and the operation of your Bluetooth® device, see the manual that comes with the Bluetooth® device.
- The music profiles the paired device supports can be connected individually as desired. Some devices do not allow individual profiles to be connected. In that case, a pop-up window is displayed.

■ PAIRING FROM THE DEVICE

1 Select “Make system discoverable”.

▶ When another Bluetooth® device is already connected, a message will appear.

- To disconnect the Bluetooth® device, select “YES”.

▶ When 4 Bluetooth® devices have already been paired, a message will appear.

- A paired device needs to be replaced. Select “OK”, and select the device to be replaced.

2 When this screen is displayed, search for the system on the screen of your Bluetooth® device.

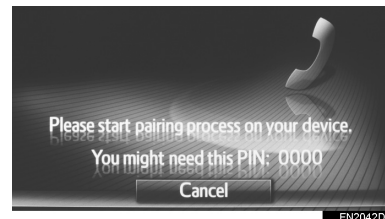

- To cancel the registration, select “Cancel”.

3 Pairing the Bluetooth® device using your Bluetooth® device.

- A PIN code is not required for SSP (Secure Simple Pairing) compatible Bluetooth® devices. Depending on the type of Bluetooth® device being connected a message confirming registration may be displayed on the Bluetooth® device's screen. Respond and operate the Bluetooth® device according to the confirmation message.

1. SETUP OPERATION

■ LOGIN PROCESS INTERNET PROFILE

▶ If “Connect for Internet” is selected

1 Select “Connect for Internet”.

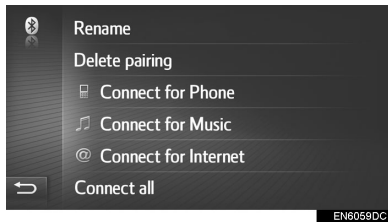

● If the automatic connection failed, the following screen will be displayed. Select the desired provider to be connected.

2 Select the desired provider.

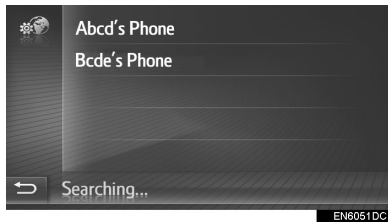

3 Select “Provider username”, “Provider password” or “APN” and enter the name, password or APN.

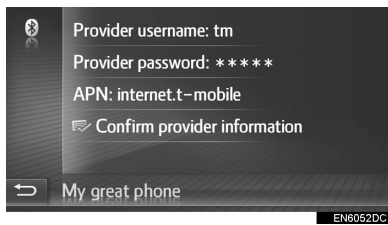

4 Select “Confirm provider information”.

▶ If  is selected

1 Select .

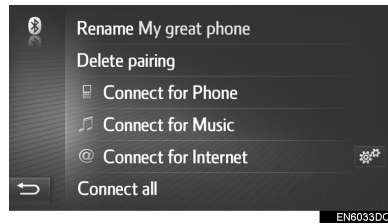

2 Follow the steps “LOGIN PROCESS INTERNET PROFILE” from “STEP 2”. (→P.136)

■ RECONNECTING Bluetooth® DEVICE

If a Bluetooth® device is disconnected due to poor reception from the Bluetooth® network when the engine switch is in the following status, the system will automatically reconnect the Bluetooth® device.

▶ Vehicles without smart entry & start system

The engine switch is turned to the “ACC” or “ON” position.

▶ Vehicles with smart entry & start system

The engine switch is turned to ACCESSORY or IGNITION ON mode.

- If the Bluetooth® device is disconnected on purpose, such as it was turned off, this does not happen. Reconnect it manually using either of the following methods:
 - Select a Bluetooth® device again. (→P.140)
 - Connect the audio profile/phone profile. (→P.140)

■ PROFILES

This system supports the following services.

Bluetooth® device	Specification	Function	Requirements	Recommendations
Bluetooth® Phone/ Bluetooth® Audio Player	Bluetooth® Specification	Registering a Bluetooth® device	Ver. 1.1	Ver. 3.0 +EDR
Bluetooth® device	Profile	Function	Requirements	Recommendations
Bluetooth® Phone	HFP (Hands-Free Profile)	Hands-free system	Ver. 1.0	Ver. 1.6
	PBAP (Phone Book Access Profile)	Transferring the contacts	Ver. 1.0	Ver. 1.1
	MAP (Message Access Profile)	Bluetooth® phone message	Ver. 1.0	—
	DUN (Dial-up Networking Profile)	Connected service	Ver. 1.1	—
	PAN (Personal Area Networking)		Ver. 1.0	—
Bluetooth® Audio Player	A2DP (Advanced Audio Distribution Profile)	Bluetooth® audio system	Ver. 1.0	Ver. 1.2
	AVRCP (Audio/Video Remote Control Profile)		Ver. 1.0	Ver. 1.4

INFORMATION

- If your cellular phone does not support HFP, registering the Bluetooth® phone or using PBAP, MAP, DUN or PAN profiles individually will not be possible.
- If the connected Bluetooth® device version is older than recommended or incompatible, the Bluetooth® device function may not work properly.



Bluetooth is a registered trademark of Bluetooth SIG, Inc.

■ STATUS DISPLAY

The condition of the Bluetooth® connection, as well as the level of reception and the amount of device battery charge left, are displayed on the status bar.

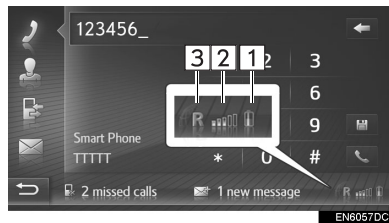

INFORMATION

- An antenna for the Bluetooth® connection is built into the instrument panel. The system may not function when you use the Bluetooth® device in the following conditions and places:
 - When the device is obstructed by certain objects (such as when it is behind the seat or in the glove box and console box).
 - When the device touches or is covered with metal materials.

No.	Function
1	<p>Displays the charge level of the device's battery</p> <ul style="list-style-type: none"> • The amount displayed does not always correspond with the amount displayed on the device. The amount of battery charge left may not be displayed depending on the device. This system does not have a charging function. • If this information is not available from the connected device, the icon will be shown with a question mark.
2	<p>Displays the level of reception</p> <ul style="list-style-type: none"> • The level of reception does not always correspond with the level displayed on the device. • The level of reception may not be displayed depending on the device. • If this information is not available from the connected device, the icon will be shown with a question mark.
3	<p>"R" is displayed when receiving in a roaming area.</p> <ul style="list-style-type: none"> • The receiving area may not be displayed depending on the phone.

1. SETUP OPERATION

PAIRED DEVICE LIST

Each profile connection status can be changed from the “Paired device list”.

- 1 Select “**Paired device list**”.
- 2 Select the desired device.

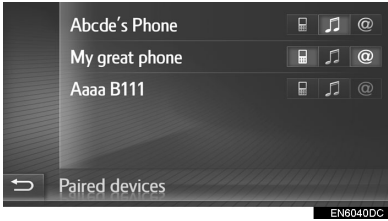

- Dimmed icons can be selected to connect to the function directly.
- The tone of the icons show which profiles the device supports. (Dimmed icons are not available.)
- The device’s currently connected profiles are highlighted.

- 3 Check that the following screen is displayed.

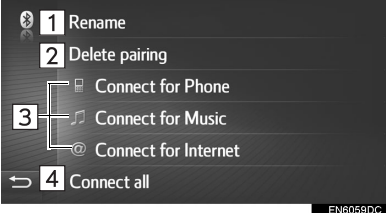

No.	Function	Page
1	Select to change the device name.	140
2	Select to delete the paired device.	140
3	Select to connect/disconnect individually a paired device’s profiles.	—
4	<ul style="list-style-type: none"> ▶When “Connect all” displayed <ul style="list-style-type: none"> • Select to connect all supported profiles. ▶When “Disconnect all” displayed <ul style="list-style-type: none"> • Select to disconnect all supported profiles. 	—

■ CHANGING THE DEVICE NAME

- 1 Select “**Rename**”.
- 2 Enter the device name and then select “**OK**”.

■ DELETING A PAIRED DEVICE

- 1 Select “**Delete pairing**”.
- 2 Select “**Yes**” when the confirmation screen appears.

SETTING CHARGE WARNINGS

- 1 Select "Charge warnings".
- 2 Select items to be set.



No.	Function
1	Enable to set the cost warnings function on/off. When set to on, a pop-up window will be displayed.
2	Enable to set the roaming warning function on/off.

SETTING THE SYSTEM NAME AND PIN

- 1 Select "Set system name and PIN".
- 2 Select item to be set.

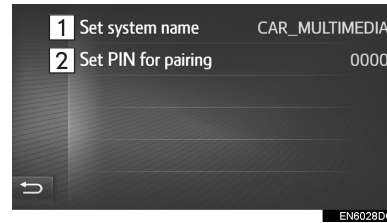

No.	Function
1	Select to enter a name. To confirm, select "OK".
2	Select to enter a desired number. To confirm, select "OK". • A PIN code must be 4 digits.

6

SETUP

Wi-Fi® SETTINGS*

- 1 Display the connectivity settings screen. (→P.132)
- 2 Select “Wi-Fi”.

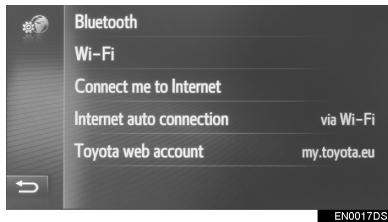

- 3 Select the items to be set.

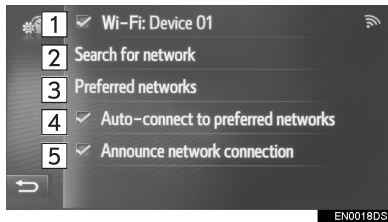

No.	Function	Page
1	Select to turn the Wi-Fi® function on/off.	142
2	Select to start a search for available Wi-Fi® networks.	143
3	Select to edit the list of preferred networks.	144
4	Enable to automatically connect to preferred networks.	—
5	Enable to display when a network connection is made.	—

TURNING Wi-Fi® FUNCTION ON/OFF

- 1 Display the Wi-Fi® settings screen. (→P.142)
 - 2 Select “Wi-Fi:”.
- When set to on, the name of the connected network is shown and the signal strength is indicated by an icon.



*: If equipped

CONNECTING TO A NETWORK

Available networks can be searched for and connected to.

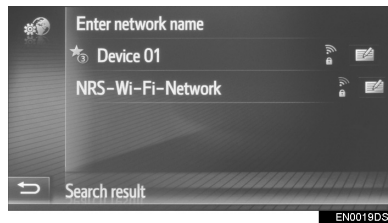
- 1 Display the Wi-Fi® settings screen. (→P.142)
- 2 Select **“Search for network”**.
- 3 Select the desired network. Connection to the selected network is established.



- When a network with  is selected and the password entry screen is displayed, enter the password then select **“OK”**
- The networks, that were added to list of preferred networks, are marked with .
- Select  to show details about the network or add the selected network to the list of preferred networks.

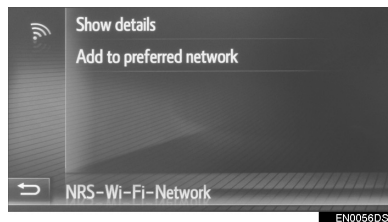

“Show details”: Select to display details about the network.

“Add to preferred networks”: Select to add a Wi-Fi® network to the list of preferred networks.

ADDING A Wi-Fi® NETWORK

Available networks which are not displayed by searching can be added.

- 1 Select **“Enter network name”**.

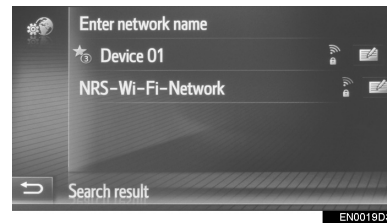

- 2 Enter the network name and select **“OK”**.
- 3 Select the security type.
- 4 Enter the password and select **“OK”**.

6

SETUP

PREFERRED NETWORKS

The list of preferred networks is displayed. The priority of the networks to connect to can be changed.

- 1 Display the Wi-Fi® settings screen. (→P.142)
- 2 Select “Preferred networks”.
- 3 Drag and drop the desired network on the screen to change the connection priority of the network.

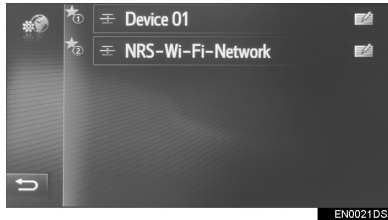

- If the name of one of the preferred network is selected, the connection to the network is established.

- Selecting  of a network, a sub-menu with the following entries is shown:

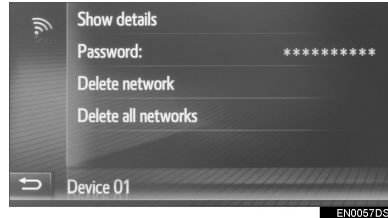

“Show details”: A screen is shown with details of the network.

“Password:”: The password can be re-entered.

“Delete network”: Removes the network from the list of preferred networks.

“Delete all networks”: Removes all networks from the list of preferred networks.

INFORMATION

- If a network is being connected to, preferred network settings cannot be changed.

Wi-Fi® FUNCTION OPERATING HINTS

CAUTION

- Use Wi-Fi® devices only when safe and legal to do so.
- Your audio unit is fitted with Wi-Fi® antennas. People with implantable cardiac pacemakers, cardiac resynchronization therapy-pacemakers or implantable cardioverter defibrillators should maintain a reasonable distance between themselves and the Wi-Fi® antennas.
The radio waves may affect the operation of such devices.
- Before using Wi-Fi® devices, users of any electrical medical device other than implantable cardiac pacemakers, cardiac resynchronization therapy-pacemakers or implantable cardioverter defibrillators should consult the manufacturer of the device for information about its operation under the influence of radio waves.
Radio waves could have unexpected effects on the operation of such medical devices.

SPECIFICATIONS

INFORMATION

- Communication standards
 - 802.11b
 - 802.11g
 - 802.11n
- Security
 - WEP
 - WPA™
 - WPA2™
 - Wi-Fi Protected Setup™
 - WPA, WPA2 and Wi-Fi Protected Setup are registered mark of the Wi-Fi Alliance®.

QUICK SETUP OF AN INTERNET CONNECTION

This function is a shortcut for an internet connection.

- 1 Display the connectivity settings screen. (→P.132)
- 2 Select **“Connect me to Internet”**.
 - When an Internet connection is already active, a popup window is displayed. To return to the previous screen, select the **“OK”**.
- 3 Select the desired device.

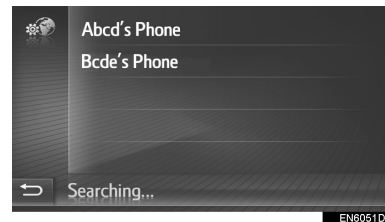

- The system search for devices which support the Internet profile.
- 4 Select **“Provider username”**, **“Provider password”** or **“APN”** and enter the name, password or APN.

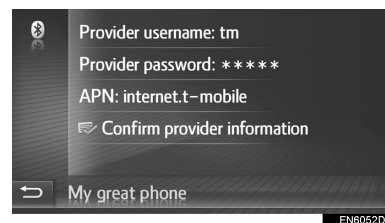

- 5 Select **“Confirm provider information”**.

6

SETUP

1. SETUP OPERATION

TOYOTA WEB ACCOUNT SETTINGS

The following detailed Toyota web account settings can be set.

- 1 Display the connectivity settings screen. (→P.132)
- 2 Select “Toyota web account”.
- 3 Select items to be set.

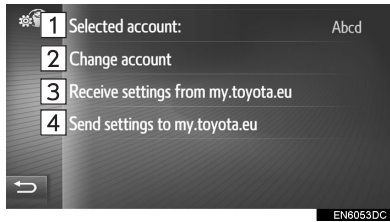

No.	Function
1	Shows active account
2	Select to add a new account or change to another account. (→P.146)
3	Select to receive the remotely customised vehicle settings data from the Toyota portal site.
4	Select to send the vehicle's settings data that can be customised remotely to the Toyota portal site.

ADDING A NEW ACCOUNT OR CHANGING AN ACCOUNT DETAILS

- 1 Display the Toyota web account settings screen. (→P.146)
- 2 Select “Change account”.
- 3 Select “New account” or  .

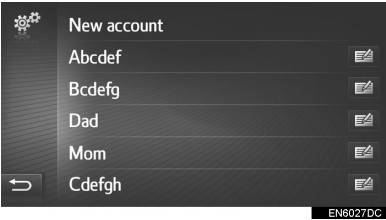

4 Select items to be set.

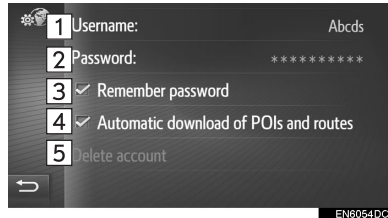

No.	Function
1	Select to enter a username. To confirm, select “OK” .
2	Select to enter a password. To confirm, select “OK” .
3	Select to turn the remember user login information function on or off. When this function is activated, the entered user login information will be remembered for every user login.
4	Select to turn the automatic download of POIs and routes function on or off. When this function is activated, the POIs and routes from the server will be downloaded automatically and saved in the “Stored” list on the “My destinations” screen. (→P.210)
5	Select to delete your Toyota web account from the navigation system. (→P.147)

■ DELETING USER NAME AND PASSWORD

- 1 Select **“Delete account”**.
- 2 Select **“Yes”** when the confirmation screen appears.

1. SETUP OPERATION

6. TELEPHONE SETTINGS

Settings are available for ringtone selection, announcing incoming short messages and e-mails etc.

1 Display the "Setup" screen. (→P.118)

2 Select "Phone".

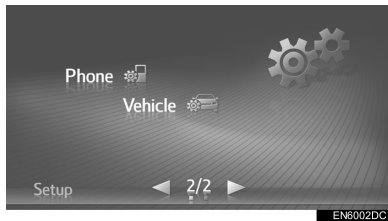

3 Select items to be set.

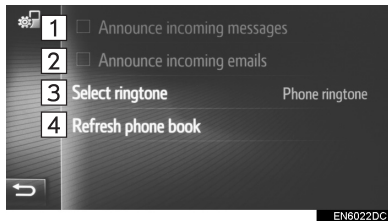

No.	Function
1	Select to set the incoming short message announcement function on/off.
2	Select to set the incoming e-mail announcement function on/off.
3	Select to set the desired ringtone.
4	Select to update the phone book of the connected phone manually. The updating takes place by referring to the phone book lists in the navigation/multimedia system and phone. (→P.83, 210)

INFORMATION

- The current setting of each item is displayed on its right.

1. SETUP OPERATION

7. AUDIO SETTINGS

- 1 Display the “Setup” screen. (→P.118)
- 2 Select “Audio”.

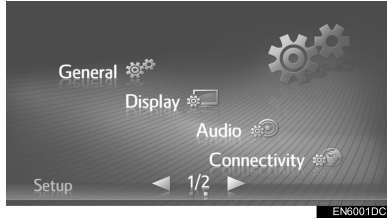

- 3 Select items to be set.

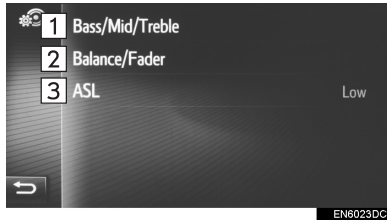

No.	Function	Page
1	Select to adjust the bass/mid/treble.	149
2	Select to adjust the balance/fader.	150
3	Select to set the ASL to low, mid, high or off.	150

TONE

How good an audio program sounds is largely determined by the mix of the treble, mid and bass levels. In fact, different kinds of music and vocal programs usually sound better with different mixes of treble, mid and bass.

- 1 Display the audio settings screen. (→P.149)
- 2 Select “Bass/Mid/Treble”.
- 3 Adjust the level of the bass, mid and treble selecting ◀ or ▶.

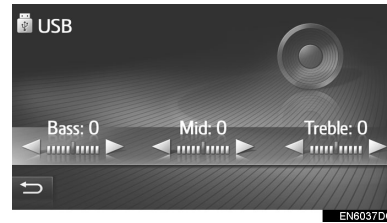

6

SETUP

1. SETUP OPERATION

BALANCE

A good balance of the left and right stereo channels and of the front and rear sound levels is also important.

Keep in mind that when listening to a stereo recording or broadcast, changing the right/left balance will increase the volume of one group of sounds while decreasing the volume of another.

- 1 Display the audio settings screen. (→P.149)
- 2 Select “Balance/Fader”.
- 3 Adjust the balance or fader selecting arrows.

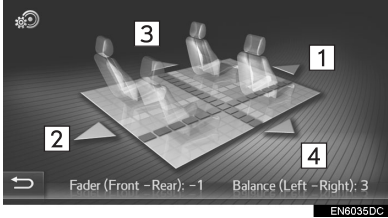

No.	Function	
1	Fader	Increases the volume to the front side
2	Fader	Increases the volume to the rear side
3	Balance	Increases the volume to the left side
4	Balance	Increases the volume to the right side

INFORMATION

- Sound balance can also be adjusted by touching and dragging the marker on the screen with your finger or touching the quadrants.

AUTOMATIC SOUND LEVELIZER (ASL)

The system adjusts to the optimum volume and tone quality according to vehicle speed to compensate for increased vehicle noise.

1. SETUP OPERATION

8. VEHICLE SETTINGS

Vehicle customisation settings can be changed.

- 1 Display the “Setup” screen. (→P.118)
- 2 Select “**Vehicle**”.

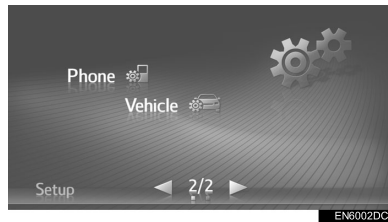

- 3 Select “**Vehicle customisation**”.
- 4 Check that the “Vehicle customisation” list is displayed.
- 5 Select the desired item.
 - For a list of the settings that can be changed, refer to “*Owner’s manual*”.
 - A message indicating that the settings are being saved will appear. Do not perform any other operations while this message is displayed.

1. SETUP OPERATION

7

REAR VIEW MONITOR SYSTEM

1 REAR VIEW MONITOR SYSTEM

- 1. REAR VIEW MONITOR SYSTEM 154
 - REAR VIEW MONITOR SYSTEM 154
 - DRIVING PRECAUTIONS 154
 - SCREEN DESCRIPTION 156
- 2. REAR VIEW MONITOR SYSTEM PRECAUTIONS 158
 - AREA DISPLAYED ON SCREEN 158
 - THE CAMERA 159
 - DIFFERENCES BETWEEN THE SCREEN AND THE ACTUAL ROAD 160
 - WHEN APPROACHING THREE-DIMENSIONAL OBJECTS 162
- 3. THINGS YOU SHOULD KNOW 164
 - IF YOU NOTICE ANY SYMPTOMS 164

- 1
- 2
- 3
- 4
- 5
- 6
- 7
- 8
- 9

Some of the functions cannot be operated while driving.

1. REAR VIEW MONITOR SYSTEM

1. REAR VIEW MONITOR SYSTEM

REAR VIEW MONITOR SYSTEM

The rear view monitor system assists the driver by displaying an image of the view behind the vehicle with fixed guide lines on the screen while backing up, for example while parking.

INFORMATION

- The screen illustrations used in this text are intended as examples, and may differ from the image that is actually displayed on the screen.

DRIVING PRECAUTIONS

The rear view monitor system is a supplemental device intended to assist the driver when backing up. When backing up, be sure to visually check all around the vehicle both directly and using the mirrors before proceeding. If you do not, you may hit another vehicle, and could possibly cause an accident.

Pay attention to the following precautions when using the rear view monitor system.

! CAUTION

- Never depend on the rear view monitor system entirely when backing up. The image and the position of the guide lines displayed on the screen may differ from the actual state.
Use caution, just as you would when backing up any vehicle.
- Be sure to back up slowly, depressing the brake pedal to control vehicle speed.
- The instructions given are only guidelines. When and how much to turn the steering wheel will vary according to traffic conditions, road surface conditions, vehicle condition, etc. when parking. It is necessary to be fully aware of this before using the rear view monitor system.
- When parking, be sure to check that the parking space will accommodate your vehicle before maneuvering into it.

! CAUTION

- Do not use rear view monitor system in the following cases:
 - On icy or slick road surfaces, or in snow
 - When using tyre chains or emergency tyres
 - When the back door is not closed completely
 - On roads that are not flat or straight, such as curves or slopes.
- In low temperatures, the screen may darken or the image may become faint. The image could distort when the vehicle is moving, or you may become unable to see the image on the screen. Be sure to visually check all around the vehicle both directly and using the mirrors before proceeding.
- If the tyre sizes are changed, the position of the fixed guide lines displayed on the screen may change.
- The camera uses a special lens. The distances between objects and pedestrians that appear in the image displayed on the screen will differ from the actual distances.(→P.160)

1. REAR VIEW MONITOR SYSTEM

SCREEN DESCRIPTION

- ▶ Vehicles without smart entry & start system
The rear view monitor system screen will be displayed if the shift lever is shifted to the “R” position while the engine switch is in the “ON” position.
- ▶ Vehicles with smart entry & start system
The rear view monitor system screen will be displayed if the shift lever is shifted to the “R” position while the engine switch is in IGNITION ON mode.

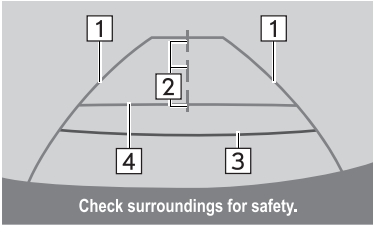

EN5010DC

No.	Display	Function
1	Vehicle width guide lines	Displays a guide path when the vehicle is being backed straight up. <ul style="list-style-type: none"> • The displayed width is wider than the actual vehicle width.
2	Vehicle centre guide lines	These lines indicate the estimated vehicle centre on the ground.
3	Distance guide line	Shows distance behind the vehicle. <ul style="list-style-type: none"> • Displays a point approximately 0.5 m (1.5 ft.) (red) from the edge of the bumper.
4	Distance guide line	Shows distance behind the vehicle. <ul style="list-style-type: none"> • Displays a point approximately 1 m (3 ft.) (blue) from the edge of the bumper.

CANCELING REAR VIEW MONITOR SYSTEM

The rear view monitor system is canceled when the shift lever is shifted into any position other than the “R” position.

- When the shift lever is shifted to the “R” position and any mode button (such as “**MEDIA**”) is pressed
 - ➔ The rear view monitor system is canceled, and the screen is switched to the mode of the button that was pressed.

1. REAR VIEW MONITOR SYSTEM

2. REAR VIEW MONITOR SYSTEM PRECAUTIONS

AREA DISPLAYED ON SCREEN

The rear view monitor system displays an image of the view from the bumper of the rear area of the vehicle.

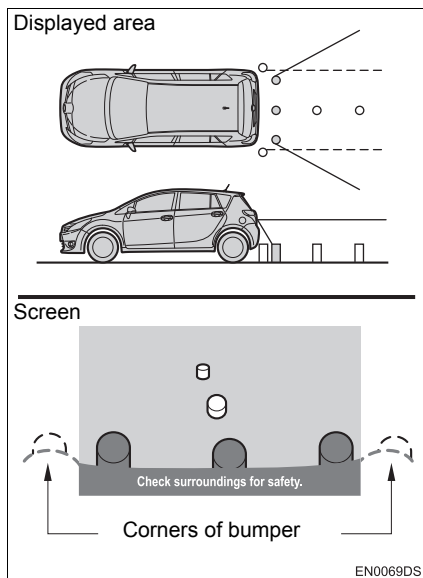

INFORMATION

- The area displayed on the screen may vary according to vehicle orientation conditions.
- Objects which are close to either corner of the bumper or under the bumper cannot be displayed.
- The camera uses a special lens. The distance of the image that appears on the screen differs from the actual distance.
- Items which are located higher than the camera may not be displayed on the monitor.

- The image adjustment procedure for the rear view monitor system screen is the same as the procedure for adjusting the navigation/multimedia system screen. (→P.123)

THE CAMERA

The camera for the rear view monitor system is located as shown in the illustration.

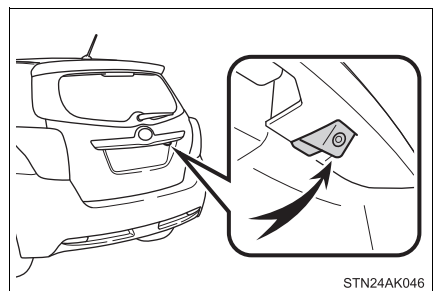
**USING THE CAMERA**

If the camera lens becomes dirty, it cannot transmit a clear image. If water droplets, snow or mud adhere to the lens, rinse with water and wipe with a soft cloth. If the lens is extremely dirty, wash it with a mild cleanser and rinse.

NOTICE

- The rear view monitor system may not operate properly in the following cases.
 - If the back of the vehicle is hit, the position and mounting angle of the camera may change.
 - As the camera has a water proof construction, do not detach, disassemble or modify it. This may cause incorrect operation.
 - Do not strongly rub the camera lens. If the camera lens is scratched, it cannot transmit a clear image.
 - Do not allow organic solvent, car wax, window cleaner or glass coat to adhere to the camera. If this happens, wipe it off as soon as possible.
 - If the temperature changes rapidly, such as when hot water is poured on the vehicle in cold weather, the system may not operate normally.
 - When washing the vehicle, do not apply intensive bursts of water to the camera or camera area. Doing so may result in the camera malfunctioning.
- Do not expose the camera to strong impact as this could cause a malfunction. If this happens, have the vehicle inspected by your Toyota dealer or another duly qualified and equipped professional as soon as possible.

DIFFERENCES BETWEEN THE SCREEN AND THE ACTUAL ROAD

- The distance guide lines and the vehicle width guide lines may not actually be parallel with the dividing lines of the parking space, even when they appear to be so. Be sure to check visually.
- The distances between the vehicle width guide lines and the left and right dividing lines of the parking space may not be equal, even when they appear to be so. Be sure to check visually.
- The distance guide lines give a distance guide for flat road surfaces. In any of the following situations, there is a margin of error between the fixed guide lines on the screen and the actual distance /course on the road.

WHEN THE GROUND BEHIND THE VEHICLE SLOPES UP SHARPLY

The distance guide lines will appear to be closer to the vehicle than the actual distance. Because of this, objects will appear to be farther away than they actually are. In the same way, there will be a margin of error between the guidelines and the actual distance/course on the road.

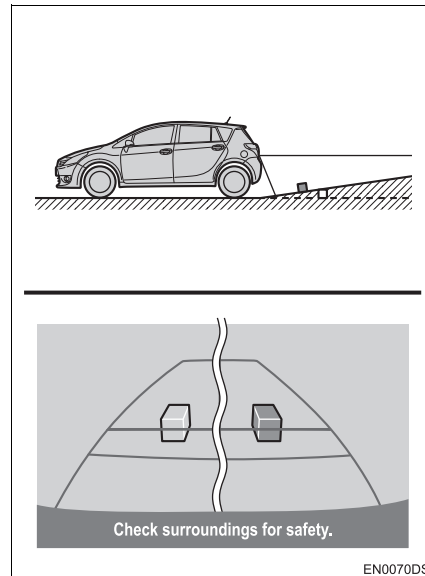

WHEN THE GROUND BEHIND THE VEHICLE SLOPES DOWN SHARPLY

The distance guide lines will appear to be further from the vehicle than the actual distance. Because of this, objects will appear to be closer than they actually are. In the same way, there will be a margin of error between the guide-lines and the actual distance/course on the road.

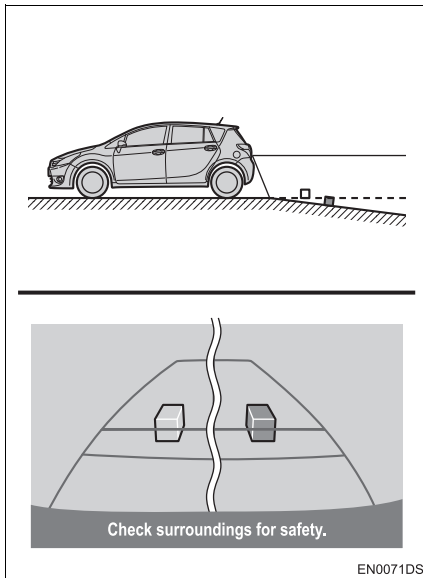

WHEN ANY PART OF THE VEHICLE SAGS

When any part of the vehicle sags due to the number of passengers or the distribution of the load, there is a margin of error between the fixed guide lines on the screen and the actual distance/course on the road.

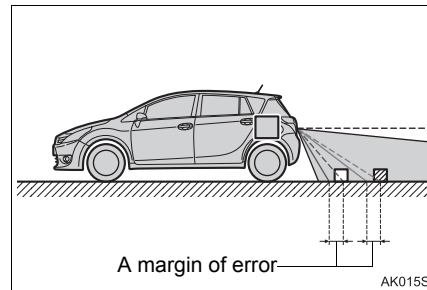

WHEN APPROACHING THREE-DIMENSIONAL OBJECTS

The distance guide lines are displayed according to flat surfaced objects (such as the road). It is not possible to determine the position of three-dimensional objects (such as vehicles) using the distance guide lines. When approaching a three-dimensional object that extends outward (such as the flat-bed of a truck), be careful of the following.

VEHICLE WIDTH GUIDE LINES

Visually check the surroundings and the area behind the vehicle. In the case shown below, the truck appears to be outside of the vehicle width guide lines and the vehicle does not look as if it hits the truck. However, the rear body of the truck may actually cross over the vehicle width guide lines. In reality if you back up as guided by the vehicle width guide lines, the vehicle may hit the truck.

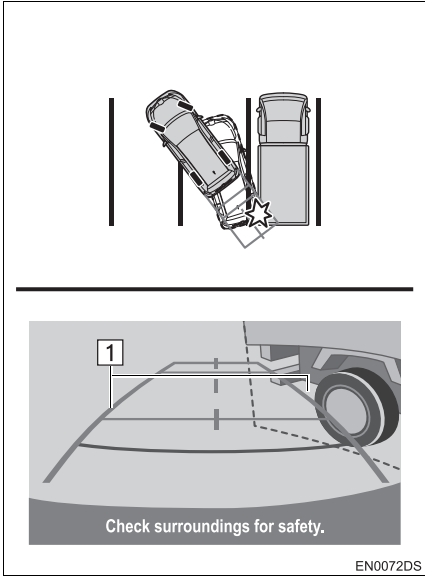

▶ 1 Vehicle width guide lines

DISTANCE GUIDE LINES

Visually check the surroundings and the area behind the vehicle. On the screen, it appears that a truck is parking at point B. However, in reality if you back up to point A, you will hit the truck. On the screen, it appears that A is closest and C is furthest away. However, in reality, the distance to A and C is the same, and B is farther than A and C.

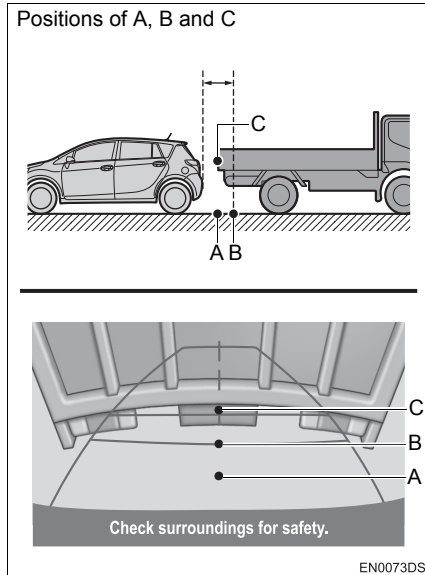

1. REAR VIEW MONITOR SYSTEM

3. THINGS YOU SHOULD KNOW

IF YOU NOTICE ANY SYMPTOMS

If you notice any of the following symptoms, refer to the likely cause and the solution, and re-check.

If the symptom is not resolved by the solution, have the vehicle inspected by your Toyota dealer or another duly qualified and equipped professional.

Symptom	Likely cause	Solution
The image is difficult to see	<ul style="list-style-type: none"> • The vehicle is in a dark area • The temperature around the lens is either high or low • The outside temperature is low • There are water droplets on the camera • It is raining or humid • Foreign matter (mud etc.) is adhering to the camera • Sunlight or headlights are shining directly into the camera • The vehicle is under fluorescent lights, sodium lights, mercury lights etc. 	<p>Back up while visually checking the vehicle's surroundings. (Use the monitor again once conditions have been improved.)</p> <p>The procedure for adjusting the picture quality of the rear view monitor system is the same as the procedure for adjusting the navigation/multimedia system screen. (→P.123)</p>
The image is blurry	Dirt or foreign matter (such as water droplets, snow, mud etc.) is adhering to the camera.	<p>Rinse the camera lens with water and wipe it clean with a soft cloth.</p> <p>Wash with a mild soap if the dirt is stubborn.</p>
The image is out of alignment	The camera or surrounding area has received a strong impact.	Have the vehicle inspected by your Toyota dealer or another duly qualified and equipped professional.
The fixed guide lines are very far out of alignment	The camera position is out of alignment.	Have the vehicle inspected by your Toyota dealer or another duly qualified and equipped professional.
	<ul style="list-style-type: none"> • The vehicle is tilted (there is a heavy load on the vehicle, tyre pressure is low due to a tyre puncture, etc.) • The vehicle is used on an incline. 	<p>If this happens due to these causes, it does not indicate a malfunction.</p> <p>Back up while visually checking the vehicle's surroundings.</p>

1. REAR VIEW MONITOR SYSTEM

7

REAR VIEW MONITOR SYSTEM

1 BASIC INFORMATION BEFORE OPERATION

1. QUICK REFERENCE..... 168

2. DISPLAYING THE NAVIGATION SCREEN 173

 DISPLAYING MAP SCREEN 173

 DISPLAYING THE NAVIGATION MENU SCREEN 173

3. NAVIGATION SYSTEM FUNCTION INDEX..... 175

2 MAP SCREEN OPERATION AND MAP ICONS

1. MAP SCREEN OPERATION 177

 CURRENT VEHICLE POSITION DISPLAY..... 177

 SCREEN SCROLL OPERATION..... 178

 MAP CONFIGURATIONS 178

2. MAP ICONS 180

 DISPLAYING VARIOUS INFORMATION ON THE MAP 180

 POI* ICONS 181

 TRAFFIC MESSAGES 185

3 DESTINATION SEARCH

1. DESTINATION SEARCH INDEX..... 188

2. SEARCH OPERATION 189

 SEARCHING BY REGISTERED POINTS..... 189

 SEARCHING FROM PREVIOUS DESTINATIONS..... 189

 SEARCHING BY PHONE BOOK 190

 SEARCHING BY ADDRESS 190

 SEARCHING BY POIs* 191

 SEARCHING ON THE MAP 194

 SEARCHING BY COORDINATES 194

4 ROUTE GUIDANCE

1. STARTING ROUTE GUIDANCE 196

 STARTING ROUTE GUIDANCE SCREEN 196

 ADJUSTING THE ROUTE..... 197

2. ROUTE GUIDANCE 199

 ROUTE GUIDANCE SCREEN 199

 VOICE GUIDANCE..... 200

8

NAVIGATION SYSTEM

3. SETTING AND DELETING THE ROUTE..... 202	6 NAVIGATION SETTING
STOPPING ROUTE GUIDANCE..... 203	1. MAP SETTINGS 221
ADDING AND EDITING STOPOVERS..... 203	SETTING THE MAP..... 221
DISPLAYING ROUTE INFORMATION..... 205	2. ROUTE SETTINGS..... 224
DISPLAYING THE TURN LIST..... 206	SETTING THE ROUTE OPTIONS..... 224
BLOCKING ROAD AHEAD..... 206	3. TRAFFIC MESSAGE SETTINGS 225
DETOURING A SEGMENT ON THE ROUTE..... 207	TRAFFIC MESSAGE SETTINGS 225
RECALCULATING THE ROUTE BY THE TRAFFIC MESSAGES 209	
5 MY DESTINATIONS	7 NAVIGATION SYSTEM INFORMATION
1. REGISTERING AN ENTRY..... 210	1. LIMITATIONS OF THE NAVIGATION SYSTEM 228
REGISTERING A NEW ENTRY 210	
2. DISPLAYING AND EDITING THE ENTRY INFORMATION..... 216	2. NAVIGATION DATABASE UPDATES..... 230
DISPLAYING AND EDITING THE ENTRY INFORMATION..... 216	UPDATING NAVIGATION DATABASE..... 230
3. SENDING AND RESTORING STORED CONTACTS USING A USB MEMORY 219	
SENDING STORED CONTACTS TO A USB MEMORY 219	
RESTORING STORED CONTACTS FROM A USB MEMORY..... 220	

Some of the functions cannot be operated while driving.

*: Point of Interest

1. BASIC INFORMATION BEFORE OPERATION

1. QUICK REFERENCE

■ “Navigation” MENU SCREEN

To display the “Navigation” menu screen, select “NAV” on the map or press the “MAP/NAV” button. When “NAV” is selected or the “MAP/NAV” button is pressed, the screen that was last displayed is returned to. Select  or press the “MAP/NAV” button again to display the “Navigation” menu screen. From this screen, destinations can be entered and route-related settings can be changed.

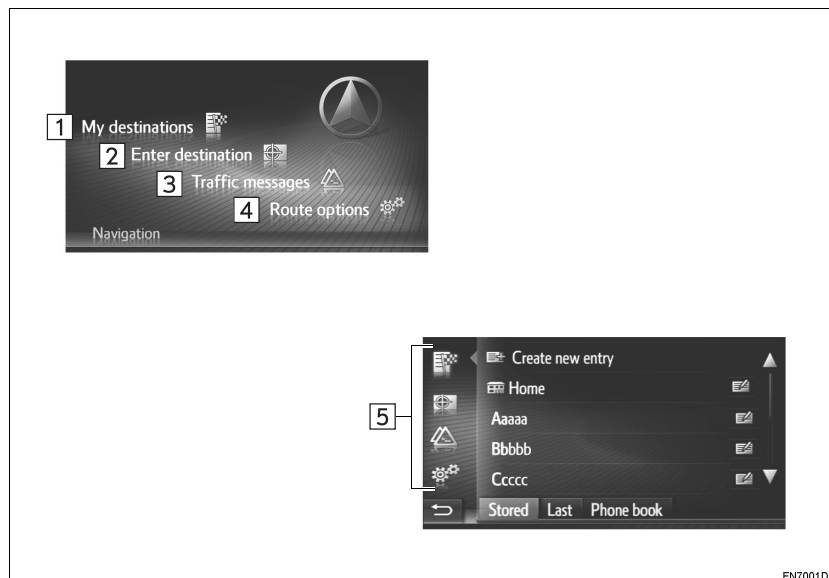

1. BASIC INFORMATION BEFORE OPERATION

No.	Function	Page
1	Select to display the "My destinations" screen. A destination can be entered by selecting an item from the list of stored destinations, previous destinations or the addresses from the connected phone's phone book.	174
2	Select to display the "Enter destination" screen. A destination can be entered by address, POI or using advanced options.	174
3	Select to display the "Traffic messages" screen. It contains a list of traffic messages relating to the set route, all traffic messages and warnings.	174
4	Select to display the "Route options" screen. The route preferences and avoidance criteria can be adjusted.	174
5	Select the corresponding icon to change to the "My destinations", "Enter destination", "Traffic messages" or "Route options" screen.	—

1. BASIC INFORMATION BEFORE OPERATION

OVERVIEW GUIDANCE SCREEN

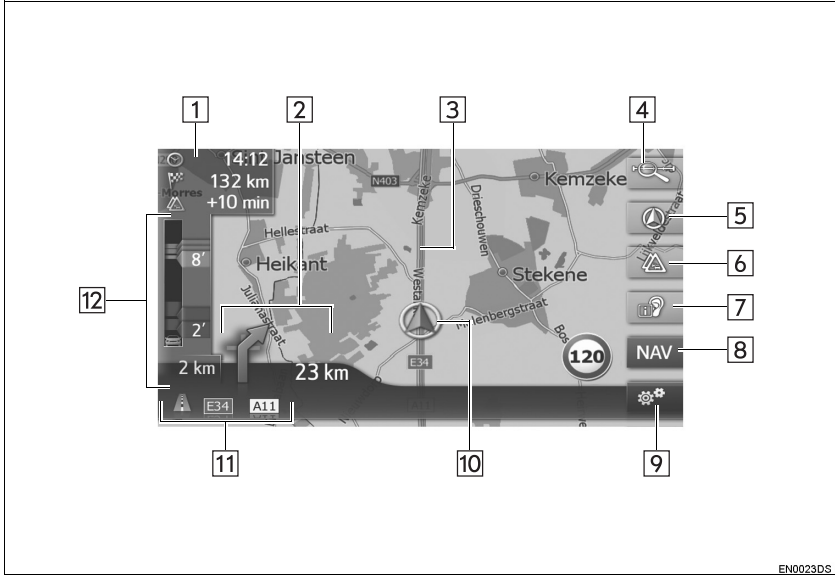

1. BASIC INFORMATION BEFORE OPERATION

No.	Function	Page
1	Displays the distance, the estimated arrival time or remaining time to the destination.	199
2	Displays the distance to the next turn with the arrow indicating the turn direction.	199
3	Guidance route	—
4	Select to change the map scale.	178
5	This symbol indicates a map layout. Selecting this symbol changes the map layout.	179
6	Select to change map modes between the normal map and traffic map.	185
7	Select to repeat the last navigation announcement.	200
8	Select to display the "Navigation" menu screen.	168
9	Select to display the options screen.	172
10	Current position	177
11	Displays the name of the current street or the next street. (when approaching a maneuver point)	—
12	Displays traffic message icon and traffic congestion.	—

■ **OPTIONS SCREEN**

To display the options screen, select  on the map.

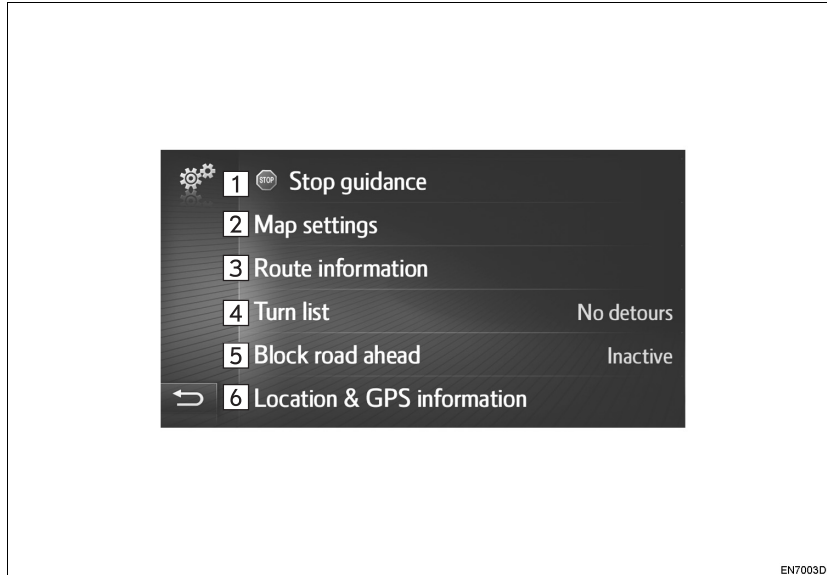

No.	Function	Page
1*	Select to stop the current route guidance.	203
2	Select to change the map setting.	221
3*	Select to display the destination and stopover information. The route preferences and the avoidance criteria for the route calculation can be changed.	205
4*	Select to display a list of the different segments of the route. It is also possible to define a detour.	206
5*	Select to block a fixed distance on the road ahead.	206
6	Select to display the current location, geo-coordinates and GPS information.	177

*: During route guidance

1. BASIC INFORMATION BEFORE OPERATION

2. DISPLAYING THE NAVIGATION SCREEN

DISPLAYING MAP SCREEN

- 1 Press the **"MAP/NAV"** button.

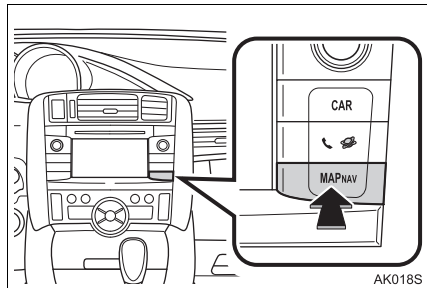

- When the **"MAP/NAV"** button is pressed, any of the navigation screens is displayed, press the **"MAP/NAV"** button again.

- 2 Select **"Confirm"**.



- After about a few seconds, the caution screen automatically switches to the map screen.

INFORMATION

- ▶ Vehicles without smart entry & start system
 - The caution screen will be displayed when the screen is changed to the map screen for the first time after the engine switch is turned to the "ACC" or "ON" position.
- ▶ Vehicles with smart entry & start system
 - The caution screen will be displayed when the screen is changed to the map screen for the first time after the engine switch is turned to ACCESSORY or IGNITION ON mode.

DISPLAYING THE NAVIGATION MENU SCREEN

- 1 Select **"NAV"** on the map or press the **"MAP/NAV"** button.

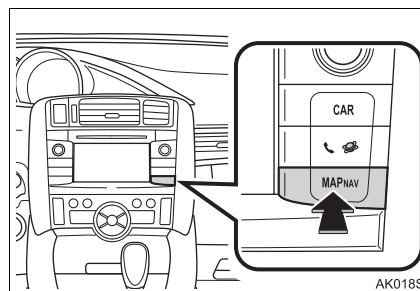

1. BASIC INFORMATION BEFORE OPERATION

2 Check that the “Navigation” menu is displayed.



No.	Function
1	Select to display the “My destinations” screen.
2	Select to display the “Enter destination” screen.
3	Select to display the “Traffic messages” screen.
4	Select to display the “Route options” screen.

- When “NAV” is selected or the “MAP/NAV” button is pressed, the screen that was last displayed is returned to. Select or press the “MAP/NAV” button to display the “Navigation” menu screen.

■ “My destinations” screen

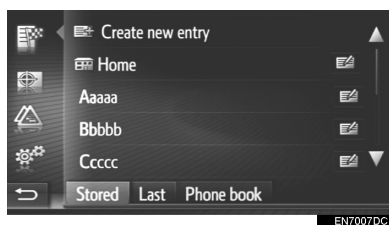

- This screen can be displayed by selecting on any of the navigation screens.

■ “Enter destination” screen



- This screen can be displayed by selecting on any of the navigation screens.

■ “Traffic messages” screen



- This screen can be displayed by selecting on any of the navigation screens.

■ “Route options” screen

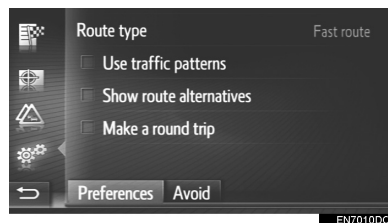

- This screen can be displayed by selecting on any of the navigation screens.

1. BASIC INFORMATION BEFORE OPERATION

3. NAVIGATION SYSTEM FUNCTION INDEX

► Map

Displaying maps	Page
Viewing the map screen	173
Displaying the current vehicle position	177
Viewing the current vehicle position vicinity map	178
Changing the scale	178
Changing the map layout	179
Displaying various information on the map	180
Displaying Point of Interest Icons	181
Viewing traffic messages	185
Searching destination	Page
Searching the destination	189
Setting the entry registered with the system as the destination	189

► Route guidance

Before starting route guidance	Page
Recalculating the route	197
Viewing alternative routes	196
Starting route guidance	196
Before starting or during route guidance	Page
Viewing the route	205
Adding destinations	203
Recalculating the route	197
Changing the estimated arrival time and remaining time display	199
During route guidance	Page
Stopping route guidance	203
Adjusting route guidance volume	200
Displaying the entire route map	205

1. BASIC INFORMATION BEFORE OPERATION

▶ Memory point

Memory point	Page
Registering the entry	210
Editing the entry	216
Loading the entry from external devices	214

2. MAP SCREEN OPERATION AND MAP ICONS

1. MAP SCREEN OPERATION

CURRENT VEHICLE POSITION DISPLAY

When starting the navigation system, the current position is displayed first. This screen displays the current vehicle position and a map of the surrounding area.



- The current vehicle position mark  appears in the centre of the map screen.

INFORMATION

- While driving, the current vehicle position mark is fixed on the screen and the map moves.
- The current position is automatically set as the vehicle receives signals from the GPS (Global Positioning System). If the current position is not correct, it is automatically corrected after the vehicle receives signals from the GPS.
- After battery disconnection, or on a new vehicle, the current position may not be correct. As soon as the system receives signals from the GPS, the correct current position is displayed.

CURRENT LOCATION AND GPS INFORMATION

- 1 Select  on the map.
- 2 Select “Location & GPS information”.

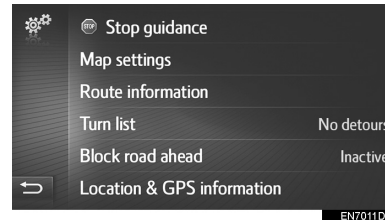

- 3 Check that current location information is displayed.



No.	Information
1	The information provided varies, depending whether the road currently being travelled on is a motorway or a street.
2	Latitude and Longitude
3	Amount of available satellites and the altitude.
4	Select to register the current position in the “Stored” list on the “My destinations” screen. (→P.210)



8

NAVIGATION SYSTEM

SCREEN SCROLL OPERATION

When any point on the map is selected, that point moves to the centre of the screen and is shown by the cursor mark .



- If a finger is continuously held on the screen, the map will continue scrolling in that direction until the finger is removed.
- A street name or geo-coordinates of the selected point will be shown, depending on the scale of the map.
- After the screen is scrolled, the map remains centred at the selected location until another function is activated. The current vehicle position mark will continue to move along your actual route and may move off the screen. When  is selected, the current vehicle position mark returns to the centre of the screen and the map moves as the vehicle proceeds along the designated route.
- When the scroll feature is used, the current vehicle position mark may disappear from the screen. Select  to display the current vehicle position on the map screen.

- When “Go” is selected, the starting route guidance screen is displayed. (→P.196)
- When “Save” is selected, the point is registered in the “Stored” list on the “My destinations” screen. (→P.210)

MAP CONFIGURATIONS

CHANGING MAP SCALE

- 1 Select the zoom bar button.



- 2 Select “+” or “-” to change the scale of the map screen.



- The scale of the map screen can also be changed the following ways:
 - Selecting the desired scale point.
 - Dragging the scale bar marking to the desired point.
 - Turning the tune/scroll knob.

INFORMATION

- The scale range is from 10 m to 500 km (150 ft. to 250 miles).
- The scale has been changed, the new scale indicator will be displayed for a while.

CHANGING MAP LAYOUT

1 Select the map layout button.



- Each time the map layout button is selected, the map layout changes as follows:

3D heading () → 2D heading () → 2D north ()

▶ 3D heading



▶ 2D heading

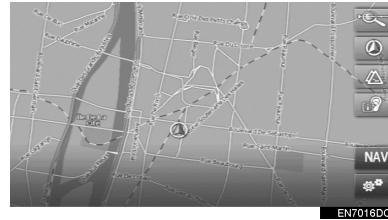

▶ 2D north

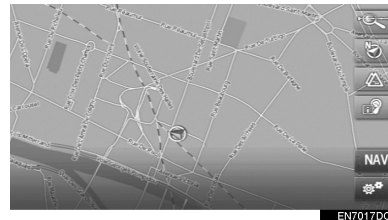

INFORMATION

- Map layout can be also changed by selecting  then "Map settings". (→P.221)

2. MAP SCREEN OPERATION AND MAP ICONS

2. MAP ICONS

DISPLAYING VARIOUS INFORMATION ON THE MAP

Various information can be displayed on the map.

SPEED LIMITS

The speed limit of the road currently being travelled on can be displayed.



3D BUILDINGS*

Buildings can be displayed in 3D on the map.



3D LANDMARKS*

Landmarks can be displayed in 3D on the map.



SAFETY CAMERAS

Safety cameras can be displayed as icons on the map.

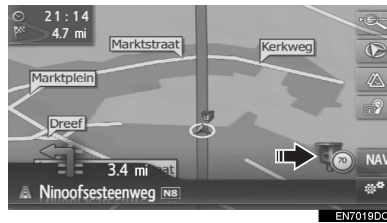

INFORMATION

- The above items will be displayed depending on the map scale.
- The above items will be displayed depending on the available map data.
- The displaying of the above items can be switched off. (→P.221)

*: If equipped

POI ICONS

DISPLAYING POI ICONS

Points of Interest such as petrol stations and restaurants can be displayed on the map screen. Their location can also be set as a destination.

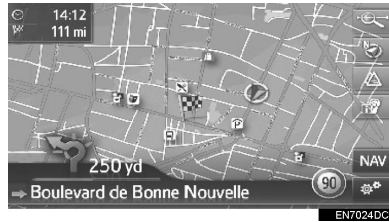

INFORMATION







- A particular type of POI icons displayed on the screen can be selected. (→P.222)

LIST OF POI ICONS









► Public









Icon	Name
	Library
	College/University
	School
	Tourist office
	Cemetery, funeral director
	Government Office, Institution, City hall, Community gen.
	Community
	Court house
	Place of worship
	Accommodation, Hotel/Motel
	Pharmacy
	Convention Centre, Exhibition Centre
	Finance, Bank
	Cash Dispenser
	Post Office
	Business, B. Company, B. General, B. facility

2. MAP SCREEN OPERATION AND MAP ICONS

Icon	Name
	Medical, Doctor, Health & Care
	Ambulance, Hospital/Polyclinic
	Fire Station
	Police Station
	Phone Box, Communication
	Dentist
	Veterinarian

► Traffic

Icon	Name
	Car Dealer/Repairer, Repair Facility, Repair General, Car Wash, Tyre Repair
	Car Dealer
	Highway Exit
	Airport, Dep. /Arrival, Ground, International, Domestic
	Bus Terminal, Bus Stop, Transportation, Public Transp. Stop, Transport general
	Railway Station
	Metropolitan Train
	Petrol Station







Icon	Name
	Rent-a-Car,-Facility, -Parking
	Ferry Terminal
	Parking, Open Parking Area, P. Area general
	Parking Garage
	Open P.A. P+R
	Rest Area
	Motoring Organization, Automobile Club
	Mover, Moving Company
	Motorcycle Dealer

► Clubbing





Icon	Name
	Multiple POI
	Bar, Nightlife
	Leisure, Cultural Centre, Theater, Music Centre, Concert Hall
	Cinema
	Casino
	Cafe/Bar, Cafe















Icon	Name
	Restaurant, French, Belgian, Chinese, German, Greek, Vegetarian, Fast Food, Grill, Sea Food, Sandwich, Steak...

► Sport

Icon	Name
	Sport, Sport General, sport activities
	Golf Course
	Race Track
	Stadium, Sports Centre, Hippodrome
	Water Sports
	Bowling
	Ski resorts

► Leisure

Icon	Name
	Amusement Park
	Winery
	Museum
	Shopping, Market Place, Shopping Centre, Factory Outlet
	Shop, Department Store, Drive-through-bottle-shop

Icon	Name
	Tourist Attractions, Important Tourist Attractions
	Park/Recreational Area
	Yacht Basin, Harbour
	Camping Ground
	Grocery Store
	Historical Monument
	RV Park, Camping
	Bookstore
	Hair & Beauty
	Photography
	Shoestore
	Wine & Liquor
	Clothing
	Cleaning & Laundry

2. MAP SCREEN OPERATION AND MAP ICONS

DISPLAYING POI INFORMATION

1 Select the desired POI icon on the map.

2 Select .

► One POI

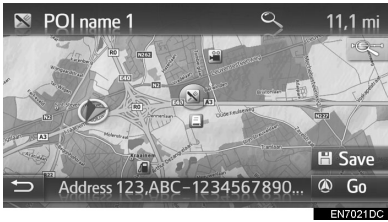

► Multiple POI

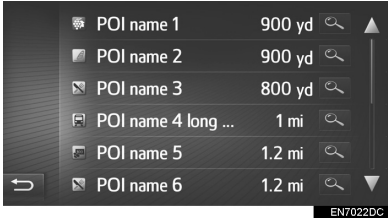

3 Check that the POI information is displayed.

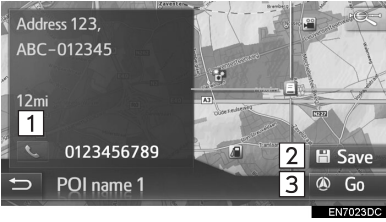

No.	Function	Page
1	Select to call the registered telephone number.	90
2	Select to register the point in the "Stored" list on the "My destinations" screen.	210
3	Select to display the starting route guidance screen.	196

TRAFFIC MESSAGES

CHANGING TO TRAFFIC MAP MODE

The map screen can change modes to normal map mode or traffic map mode.

- 1 Select the traffic icon.



- Each time the traffic icon is selected, the map mode changes.

▶ Normal map mode



▶ Traffic map mode



- Traffic message icons and speed limit display are shown.
- Traffic flow information is highlighted.

DISPLAYING DETAILED TRAFFIC INFORMATION

DISPLAYING DETAILED TRAFFIC MESSAGE ICONS

- 1 Select the desired traffic message icon on the map.



- 2 Check that the traffic message information is displayed.

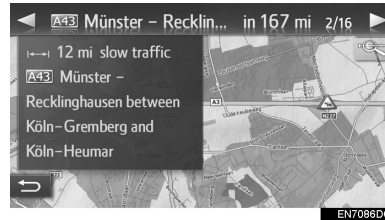

2. MAP SCREEN OPERATION AND MAP ICONS

■ DISPLAYING TRAFFIC MESSAGE LIST



- 1 Display the “Navigation” menu screen and select “Traffic messages”. (→P.173)
- 2 Select the desired tab to select the list.

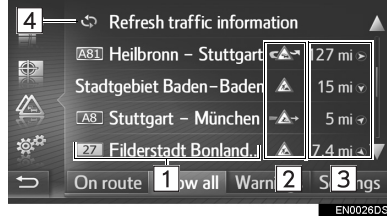

No.	Function
1	Select to display the traffic messages relating to the set route.
2	Select to display all traffic messages.
3	Select to display traffic messages with warnings.

- 3 Select the desired message.



No.	Information
1	Route segment If route segment is not available, information such as street name, city name, region or country will be displayed.
2	 : Icon of an incident  : Icon of an incident on the route  : Icon of an incident on the detoured route
3	Distance to incident and direction from vehicle
4	Select to update the traffic information. This function is available when “Refresh setting” is set to “Manual”.(→P.227)

- 4 Check that the traffic message is displayed.

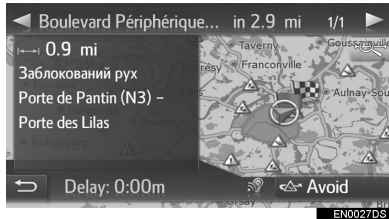

- **“Avoid”**: Select to adjust the avoidance criteria of current route before starting the route guidance. (→P.197)
- (If equipped):
When is selected, the short message is read out. To cancel this function, select .

■ LIST OF TRAFFIC MESSAGE ICONS

Icon	Name
	Slippery
	Bad weather
	Wind
	Snow fall
	Traffic
	Heavy traffic
	Accident
	Road construction
	Narrow track
	Warning
	Blockage
	Security checkpoint
	Information

3. DESTINATION SEARCH

1. DESTINATION SEARCH INDEX

There are several ways to search for a destination.

How to search a destination list	Page
Searching by registered points in the system.	189
Searching from previously set destinations.	189
Searching by the phone book of a connected cellular phone.	190
Searching by address.	190
Searching by POIs.	191
Searching on the map.	194
Searching by coordinates.	194

3. DESTINATION SEARCH

2. SEARCH OPERATION

SEARCHING BY REGISTERED POINTS

To use this function, it is necessary to register the entry. (→P.210)

- 1 Display the “Navigation” menu screen and select “**My destinations**”. (→P.173)
- 2 Select the “**Stored**” tab.
- 3 Select the desired entry.

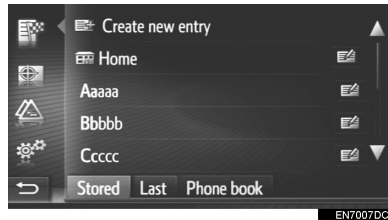

- Select  to display and edit the entry information. (→P.216)
- The route will be calculated.

INFORMATION

- If “**Home**” has not been registered, a message will be displayed and the setting screen will automatically appear. (→P.211)
- Transferred POIs and routes from an external device or the server will be stored in this list. (→P.214, 258)
- Transferred routes are marked by the specific icon.

SEARCHING FROM PREVIOUS DESTINATIONS

- 1 Display the “Navigation” menu screen and select “**My destinations**”. (→P.173)
- 2 Select the “**Last**” tab.
- 3 Select the desired entry.

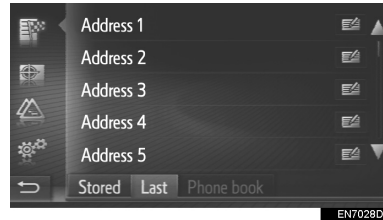

- Select  to display and edit the entry information. (→P.216)
- The route will be calculated.

INFORMATION

- The list can contain a maximum of 100 entries. When the maximum is reached, the oldest destination is deleted, making room for the new destination to be stored in the list.

SEARCHING BY PHONE BOOK

Before using this function, connect a Bluetooth® phone with a phone profile. (→P.133)

If a contact does not have address information stored, the entry will be dimmed.

- 1 Display the “Navigation” menu screen and select **“My destinations”** (→P.173)
- 2 Select the **“Phone book”** tab.
- 3 Select the desired entry.

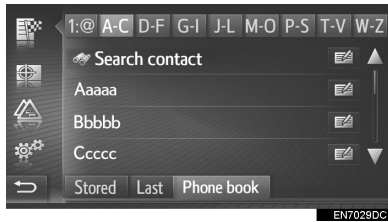

“Search contact”: Select to search by the contact’s name.

- Select  to display and edit the entry information. (→P.216)
- The route will be calculated.

SEARCHING BY ADDRESS

- 1 Display the “Navigation” menu screen and select **“Enter destination”**. (→P.173)
- 2 Select the **“Address”** tab.
- 3 Select **“Country”** to enter the desired country.



- 4 Select **“Town”** or **“Code”** to enter the town name or postal code.
 - When either a **“Town”** or **“Code”** is entered, the other will be entered automatically.
- 5 Select **“Street”** to enter the street name.
- 6 Select **“No.”** or **“Intersection”** to enter a house number or intersection name.
 - It is not possible to enter a house number and intersection at the same time.
- 7 Select **“Calculate route”**.
 - The route will be calculated.

INFORMATION

- **“Calculate route”** can be selected once a **“Town”** or **“Code”** has been entered. If **“Calculate route”** is selected when only **“Town”** or **“Code”** has been entered, a route search starts with the centre of the town entered as the destination.
- If  is selected, entered data other than **“Country”** will be deleted.

SEARCHING BY POIs

- 1 Display the “Navigation” menu screen and select **“Enter destination”**. (→P.173)
- 2 Select the **“POI”** tab.
- 3 Select the desired item.

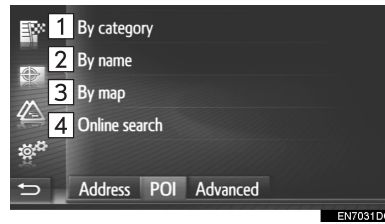

No.	Function	Page
1	Select to search by category.	192
2	Select to search by name.	193
3	Select to search by map.	193
4	Select to search by online search.	251

3. DESTINATION SEARCH

■ SEARCHING BY CATEGORY

- 1 Select **“By category”**.
- 2 Select the desired item to search the area.

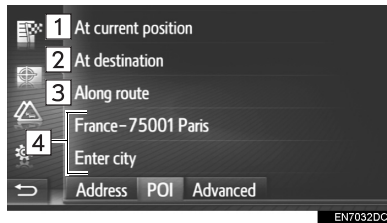

No.	Function
1	Select to set around the current position.
2	Select to set around the main destination. POIs around stopovers will not be searched.
3	Select to set around the current route.
4	Select to set the desired city. Select “Enter city” to enter the city name and then select “OK” .

- 3 Select the desired category.

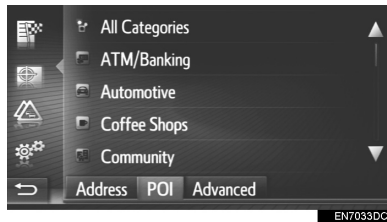

- 4 Select the desired subcategory.

- 5 Select  for the desired POI.

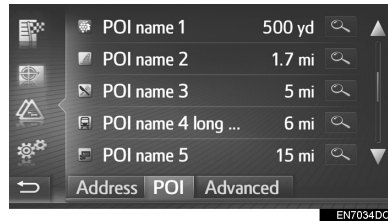

- If you select the desired POI, the route will be calculated.

- 6 Select **“Go”**.

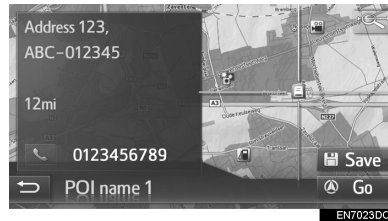

- When **“Save”** is selected, the point is registered in the **“Stored”** list on the **“My destinations”** screen. (→P.212)
- Depending on the POI information, **“Details”** will be displayed. To display detailed POI information, select **“Details”**.
- When  is selected, the registered telephone number is called.
- The route will be calculated.

INFORMATION

- Search areas are available as follows.
Search by **“At current position”**, **“At destination”** or a town name:
Search radius is 50km (30 miles).
Search by **“Along route”**:
Search area is within 500m (0.3 mile) on both sides of the route.
- The POI search result list is sorted by the distance to the POI from the following points.
Search by **“At current position”** or **“Along route”**:
The distance will be calculated from the current position to the POI.
Search by **“At destination”**: The distance will be calculated from the destination to the POI.
Search by a town name: The distance will be calculated from town centre to the POI.

SEARCHING BY NAME

- 1 Select **“By name”**.
- 2 Select the desired area to search. (→P.192)
- 3 Enter POI name and then select **“OK”**.
- 4 Follow the steps “SEARCHING “By category”” from “STEP 5”. (→P.192)

SEARCHING BY MAP

- 1 Select **“By map”**.
- 2 Select the desired POI icon on the map.
- 3 Follow the steps “SEARCHING “By category”” from “STEP 5”. (→P.192)

INFORMATION

- Depending on the current map scale, not all POI icons will be available for selection.

3. DESTINATION SEARCH

SEARCHING ON THE MAP

- 1 Display the “Navigation” menu screen and select **“Enter destination”**. (→P.173)
- 2 Select the **“Advanced”** tab.
- 3 Select **“Select point on map”**.
- 4 Select the desired point on the map.
- 5 Select **“Go”**.



- When **“Save”** is selected, the point is registered in the “Stored” list on the “My destinations” screen. (→P.212)

- The route will be calculated.

SEARCHING BY COORDINATES

Geo coordinates can be entered in DMS format (Degrees°, Minutes', Seconds"). Only coordinate values that can potentially exist are able to be entered. Impossible coordinate values and their relevant screen buttons will be dimmed.

- 1 Display the “Navigation” menu screen and select **“Enter destination”**. (→P.173)
- 2 Select the **“Advanced”** tab.
- 3 Select **“Enter geo-coordinates”**.
- 4 Select **“N”** or **“S”**.

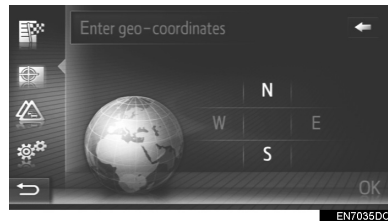

- 5 Enter the latitude.
- 6 Select **“W”** or **“E”**.
- 7 Enter the longitude.
- 8 Select **“OK”**.

9 Select “Go”.

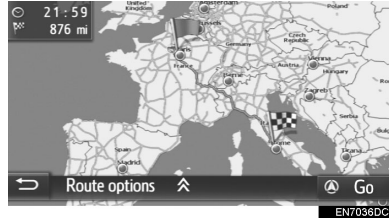

- The route will be calculated.

INFORMATION

- If a destination that is not located on a road is set, the vehicle will be guided to the point on a road nearest to the destination.

4. ROUTE GUIDANCE

1. STARTING ROUTE GUIDANCE

STARTING ROUTE GUIDANCE SCREEN

After searching the destination, the starting route guidance screen will be displayed.

According to the setting, either the recommended route screen or route alternatives screen will be displayed. (→P.224)

CAUTION

- Be sure to obey traffic regulations and keep road conditions in mind while driving. If a traffic sign on the road has been changed, the route guidance may not indicate such changed information.

RECOMMENDED ROUTE SCREEN

The recommended route will be displayed on the map.

1 Select “Go”.

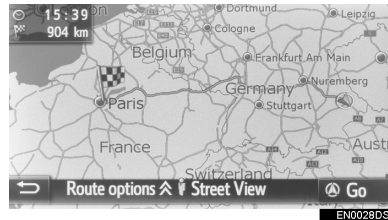

- **“Route options”**: Select to adjust the route preferences for current route and the avoidance criteria of current route before starting the route guidance. (→P.197)
- **“Street View”**: Select to display the Street View. (→P.256)
- Starts route guidance. (→P.199)

INFORMATION

- The default recommended route can be changed. (→P.224)
- The arrival time or the remaining time will be displayed in the upper left area of the map. Each time the area is selected, the display switches between displaying the arrival time and remaining time.
- Distance of the entire route is displayed on the map.
- The starting route guidance screen will always be displayed in 2D north.
- If **“Go”** is selected and held, demo mode will start. Select **“Quit”** to end demo mode.

ROUTE ALTERNATIVES SCREEN

Three route alternatives are displayed on the map.

- 1 Select one of the three route alternatives to select it.

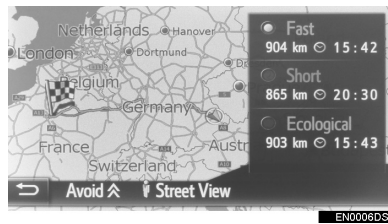

- **“Avoid”**: Select to adjust the avoidance criteria of current route before starting the route guidance. (→P.197)
- **“Street View”**: Select to display the Street View. (→P.256)
- Starts route guidance. (→P.199)

INFORMATION

- The default avoidance criteria can be changed. (→P.224)
- The arrival time and distance of the entire route will be displayed in the list.
- The starting route guidance screen will always be displayed in 2D north.

ADJUSTING THE ROUTE

► The recommended route screen

- 1 Select **“Route options”**.
- 2 Select the desired item to adjust the route preferences and the avoidance criteria.

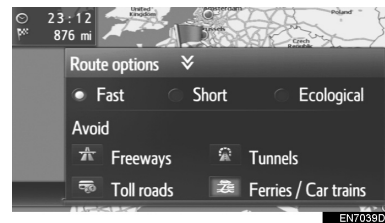

- 3 Select **“Route options”**.
- The route will be recalculated and then the starting route guidance screen will be displayed.

4. ROUTE GUIDANCE

► The route alternatives screen

- 1 Select **“Avoid”**.
- 2 Select the desired item to adjust the avoidance criteria.

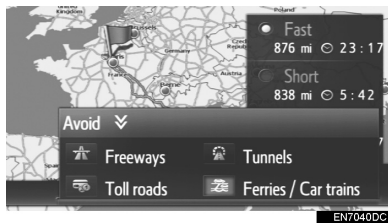

- 3 Select **“Avoid”**.
- The route will be recalculated and then the starting route guidance screen will be displayed.

INFORMATION

- Adjusting the route preference and avoidance in the above method affects current route only. Route option defaults can be changed from the “Route options” screen. (→P.224)

4. ROUTE GUIDANCE

2. ROUTE GUIDANCE

ROUTE GUIDANCE SCREEN

While guiding the route, the route guidance screen will be displayed.

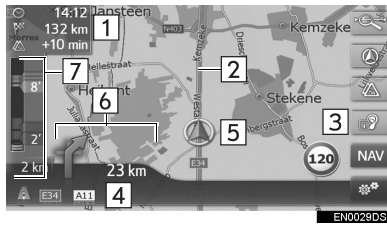

No.	Information
1	Distance and arrival or remaining time to the destination Each time information box is selected, the screen will change between arrival time and remaining time to the destination.
2	Guidance route
3	Select to repeat the last navigation announcement.
4	The name of the current street or the next street (when approaching a maneuver point)
5	Current position
6	Distance to the next turn with the arrow indicating the turn direction
7	Traffic bar indicates traffic message icon and traffic congestion.

SIGNPOSTS

When approaching the turn, a signpost will automatically be displayed.

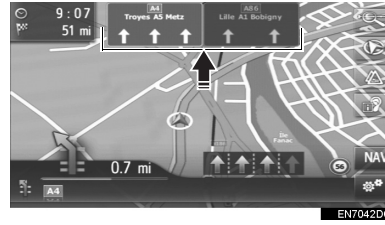

MOTORWAY JUNCTION SCREEN

When approaching a motorway junction, junction view images will automatically be displayed.



TUNNEL JUNCTION SCREEN

When approaching a tunnel junction, tunnel junction view images will automatically be displayed.

8

NAVIGATION SYSTEM

4. ROUTE GUIDANCE

LANE RECOMMENDATION

When approaching a maneuver point, the lane recommendation will automatically be displayed.

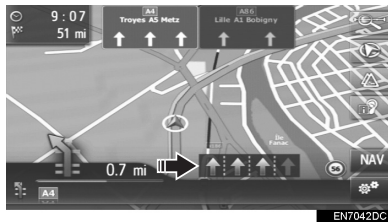

INFORMATION

- If the vehicle goes off the guided route, the route will be recalculated.
- For some areas, the roads have not been completely digitized in our database. For this reason, the route guidance may select a road that should not be traveled on.
- The above items will be displayed depending on the map scale.
- The displaying of the above items can be switched off. (→P.221)

VOICE GUIDANCE

The voice guidance provides various messages as you approach an intersection, or other points where maneuvering the vehicle is necessary.



- The voice guidance volume can be adjusted by turning the power/volume knob.
- If  is selected, the last navigation announcement will be repeated.

INFORMATION

- The voice guidance may not pronounce certain street names correctly or clearly due to the limitations of the text-to-speech function.
- On motorways, interstates or other highways with higher speed limits, the voice guidance will be made at earlier points than on city streets in order to allow time to maneuver the vehicle.
- If the system cannot determine the current vehicle position correctly (in cases of poor GPS signal reception), the voice guidance may be early or delayed.
- The voice guidance volume can also be changed. (→P.122)



CAUTION

- Be sure to obey the traffic regulations and keep the road condition in mind especially when you are driving on IPD roads (roads that are not completely digitized in our database). The route guidance may not have the updated information such as the direction of a one way street.

4. ROUTE GUIDANCE

3. SETTING AND DELETING THE ROUTE

During route guidance, routes can be checked, changed or recalculated.

Information	Page
Stopping route guidance	203
Adding and editing stopovers	203
Displaying route information	205
Displaying the turn list	206
Avoiding a road on the route	206
Detouring a maneuver point on the route	207
Recalculating the route by traffic information	209

STOPPING ROUTE GUIDANCE

- 1 Select  on the map.
- 2 Select **“Stop guidance”**.

ADDING AND EDITING STOPOVERS

ADDING STOPOVERS

In addition to the main destination, a maximum of 9 stopovers can be set.

- 1 Search for an additional stopover in the same way as a destination search. (→P.188)
- 2 Select the desired item.



No.	Function
1	Select to replace the existing destination or a stopover with a new one.
2	Select to add a stopover.
3	Select to return to the last displayed screen.

- ▶ If **“Replace”** is selected
 - The route will be recalculated.
- ▶ If **“Add”** is selected

- 3 Select **“Go”**.

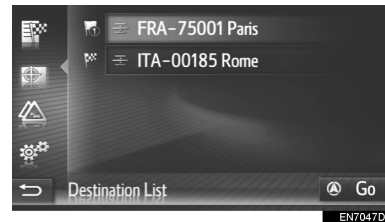

- The route will be recalculated.
- The last entered stopover is added as the first stopover and highlighted.
- The order of stopovers and destination can be changed by dragging the entry to the desired position in the list.
- If the maximum number of stopovers have already been set, a confirmation screen will appear. To delete a stopover, select **“Yes”** and select  next to the desired stopover to delete it.

EDITING STOPOVERS

DELETING STOPOVERS

- 1 Display the route information screen. (→P.205)
- 2 Select  next to the desired stopover.



- 3 Select the desired item.

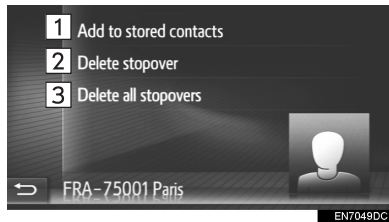

No.	Function
1	Select to register the stopover in the "Stored" list on the "My destinations" screen. (→P.210)
2	Select to delete the stopover.
3	Select to delete all stopovers.

- When the stopover(s) is deleted, the route will be recalculated

CHANGING THE ORDER OF THE STOPOVERS

- 1 Display the route information screen. (→P.205)
- 2 Drag a stopover to the desired position.
 - The route will be recalculated.

INFORMATION

- If the main destination is deleted, the last stopover before the deleted destination will become the new main destination.

DISPLAYING ROUTE INFORMATION

- 1 Select  on the map.
 - 2 Select **"Route information"**.
 - 3 Check that the destination information screen is displayed.
- Destination information (displayed when no stopovers are set)

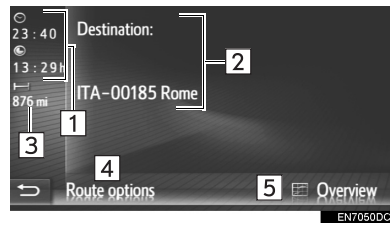

- Route information for stopovers

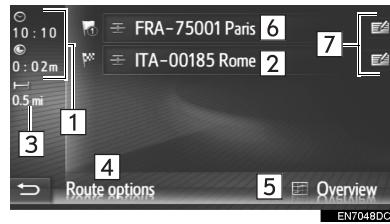

No.	Information
1	Arrival time, remaining time and distance to destination
2	Address of destination
3	Distance to the destination
4	Select to change the route preference and avoidance criteria. (→P.197)
5	Select to display route overview.
6	Address of stopovers
7	Select to edit the stopover/destination. (→P.204)

DISPLAYING THE TURN LIST

- 1 Select  on the map.
- 2 Select “Turn list”.
- 3 Select the desired item to display the segment.

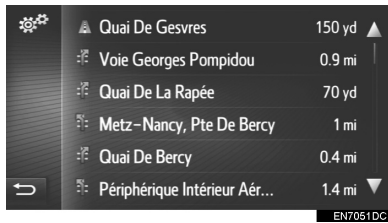

- Guidance arrow, street name, distance to the point are displayed.

- 4 Check that the detail of the segment is displayed.



- “Detour”: Select to detour the segment. (→P.207)

BLOCKING ROAD AHEAD

A fixed distance on the road ahead can be blocked.

- 1 Select  on the map.
- 2 Select “Block road ahead”.
- 3 Select the desired item to select the desired detour distance.



No.	Function
1	Select to deactivate the function.
2	Select to detour the next 2 km ~ 20 km (1 mile ~ 12 miles) of the current route (road).

- The route will be recalculated.
- A blocked route will be marked in the map.
- After the blocked route has been detoured, the block road ahead function will automatically be deactivated.

DETOURING A SEGMENT ON THE ROUTE

DETOURING A SEGMENT FROM THE TURN LIST

DETOURING THE SEGMENT

- 1 Display the turn list. (→P.206)
- 2 Select the desired segment to detour.

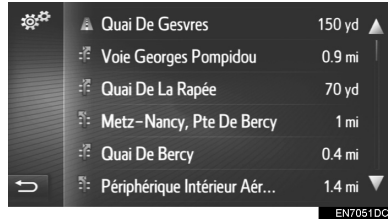

- 3 Select "Detour".



- The route will be recalculated.

CANCELLING THE DETOURED SEGMENT

- 1 Display the turn list. (→P.206)
- 2 Select "Detours".



- 3 Select "Detour off".



- If there is more than one point to detour, a list of points to detour will be displayed. Select points from the list to cancel detouring them.
- The route will be recalculated.

DETOURING A SEGMENT FROM THE TRAFFIC MESSAGE LIST

DETOURING THE SEGMENT

- 1 Display the traffic message list. (→P.185)
- 2 Select the “On route” tab.
- 3 Select the desired segment to detour.

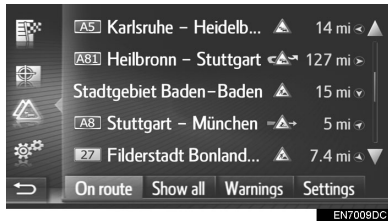

- 4 Select “Detour”.



- The route will be recalculated.
- The mark of the TMC on the “On route” screen changes into .

CANCELLING THE DETOURED SEGMENT

- 1 Display the traffic message list. (→P.185)
- 2 Select the “On route” tab.
- 3 Select the detoured segment.



- 4 Select “Detour off”.



- The route will be recalculated.
- The mark of the TMC on the “On route” screen changes to .

RECALCULATING THE ROUTE BY THE TRAFFIC MESSAGES

You will be informed about relevant traffic messages on the route by a pop-up window.

A pop-up window may differ depending on the traffic message settings. (→P.225)

► If “Automatic” is selected

- 1 Check that the confirmation screen is displayed.

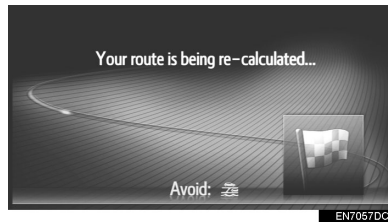

- The route will be recalculated automatically.

► If “Manual” is selected

- 1 Check that the confirmation screen is displayed.

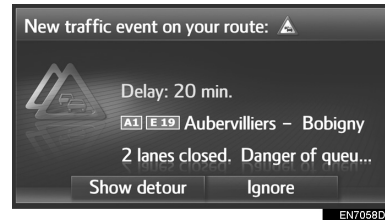

- 2 Select “Show detour”.
- Select “Ignore” to return to the previous screen.
- 3 Select “Detour”.

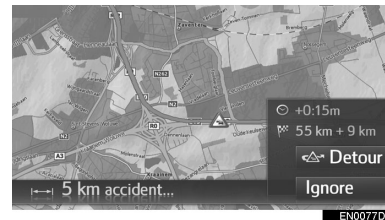

- The route will be recalculated.
- Select “Ignore” to return to the previous screen.

5. MY DESTINATIONS

1. REGISTERING AN ENTRY

REGISTERING A NEW ENTRY

Up to 200 entries can be registered with this system.

REGISTERING FROM THE “Stored” LIST

- 1 Display the “Navigation” menu screen and select “**My destinations**”. (→P.173)
- 2 Select the “**Stored**” tab.
- 3 Select “**Create new entry**”.

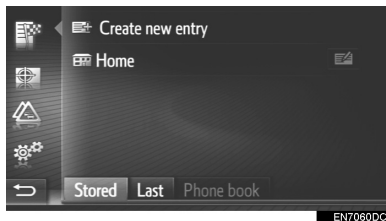

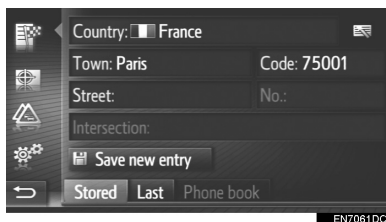

- 4 Enter the entry address (→P.190) and then select “**Save new entry**”.

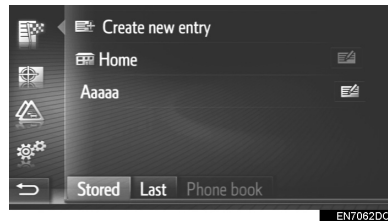

- 5 Enter the entry name and then select “**OK**”.

- 6 Check that the entry is registered in the “Stored” list.



- Select  to display and edit the entry information. (→P.216)

■ REGISTERING “Home”

If “**Home**” has not been registered, selecting “**Home**” allows a home address to be registered.

- 1 Select “**Home**”.

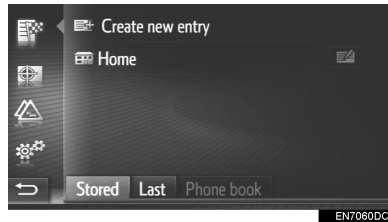

- 2 Select “**Yes**” when the confirmation screen appears.
- 3 Select the desired method to search the point.

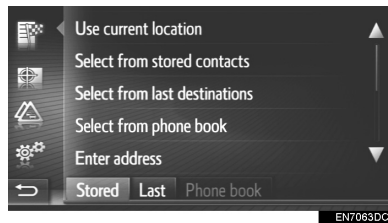

- For details about searching the point on the map: →P.189.

- ▶ If you select “**Use current location**”

- The entry is registered as “Home” in the “Stored” list.

- ▶ If you search the destination by “**Enter address**”

- 4 Enter the address and then select “**Save as Home address**”.

- ▶ If you search the destination by “**Select point on map**”

- 4 Select the desired point on the map and then select “**Save**”.

- ▶ If you search the destination by “**Enter geo-coordinates**”.

- 4 Enter geo-coordinates and then select “**Save**”.

- ▶ If you search the destination by the other methods

- 4 Select the desired entry from the list.

- Select  to display and edit the entry information. (→P.216)

REGISTERING FROM THE MAP

- 1 Select the desired point on the map.
- 2 Select **“Save”**.



- 3 Follow the steps **“REGISTERING FROM THE “Stored” LIST”** from **“STEP 5”**. (→P.210)

REGISTERING THE CURRENT POSITION

- 1 Display location & GPS information screen. (→P.177)
- 2 Select **“Save current location”**.

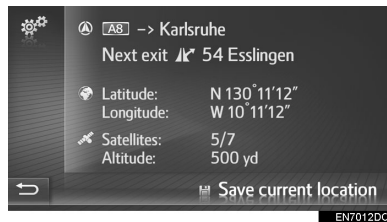

- 3 Follow the steps **“REGISTERING FROM THE “Stored” LIST”** from **“STEP 5”**. (→P.210)

REGISTERING FROM POI

- 1 Search the point by **“POI”**. (→P.191)
- 2 Select **“Save”**.

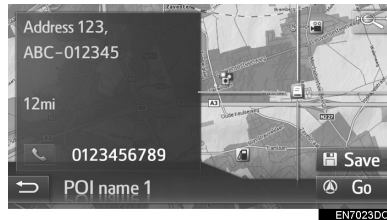

- 3 Follow the steps **“REGISTERING FROM THE “Stored” LIST”** from **“STEP 5”**. (→P.210)

REGISTERING FROM ENTRY OPTIONS SCREEN

- 1 Display entry options screen. (→P.216)
- 2 Select “Add to stored contacts”.

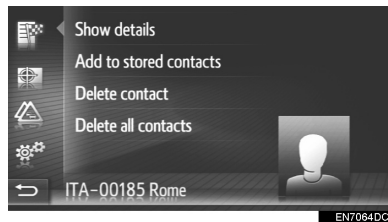

- 3 Follow the steps “REGISTERING FROM THE “Stored” LIST” from “STEP 5”. (→P.210)

INFORMATION

- If the contact includes an address and a phone number, they will be stored in the “Stored” list on the “My destinations” screen and “Contacts” screen. (→P.88, 210)

REGISTERING FROM THE ROUTE INFORMATION SCREEN

- 1 Display the route information screen. (→P.205)
- 2 Select  next to the desired stop-over or main destination.



- 3 Select “Add to stored contacts”.

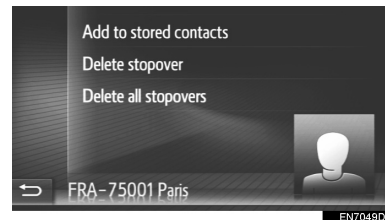

- 4 Follow the steps “REGISTERING FROM THE “Stored” LIST” from “STEP 5”. (→P.210)

REGISTERING FROM AN EXTERNAL DEVICE

LOADING POIs AND ROUTES VIA A USB MEMORY

“vCards” formatted data can be transferred from a USB memory to this system. Transferred POIs and routes will be stored in the “Stored” list on the “My destinations” screen. (→P.210)

- 1 Open the cover of the USB/AUX port.

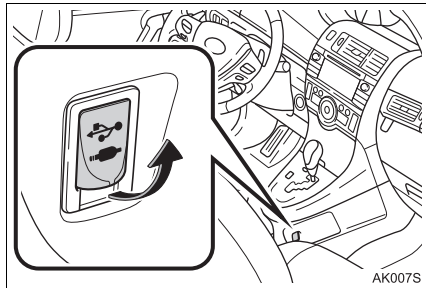

- 2 Connect a USB memory.
- 3 Display the “Navigation” menu screen and select “Enter destination”. (→P.173)
- 4 Select the “Advanced” tab.
- 5 Select “Load POIs and routes from USB”.

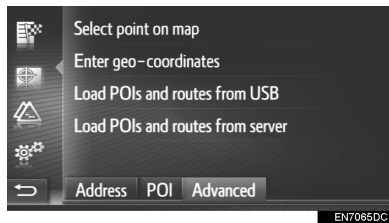

- 6 Check that a progress bar is being displayed while the data loading is in progress.
 - To cancel this function, select “Cancel”.
- 7 Check that a confirmation screen is displayed when the operation is complete.
- 8 Check that the entry is registered in the “Stored” list on the “My destinations” screen. (→P.210)

INFORMATION

- Downloading may not complete correctly in the following cases:
 - Vehicles without a smart entry & start system: If the engine switch is turned to the “LOCK” position during downloading.
 - Vehicles with a smart entry & start system: If the engine switch is turned off during downloading.
 - If the USB memory is removed before downloading is complete
- If the maximum number of possible stored contacts has been reached, a confirmation screen appears. Delete contact(s) to make room for new contact(s). (→P.85)

■ **LOADING POIs AND ROUTES
FROM A SERVER**

POIs and routes can be added by downloading from the Toyota portal site. They will be stored in the “Stored” list on the “My destinations” screen. (→P.210) For detailed information about connected service: →P.244

5. MY DESTINATIONS

2. DISPLAYING AND EDITING THE ENTRY INFORMATION

DISPLAYING AND EDITING THE ENTRY INFORMATION

- 1 Display the “Navigation” menu screen and select “**My destinations**”. (→P.173)
- 2 Select the desired tab.
- 3 Select  next to the desired entry.

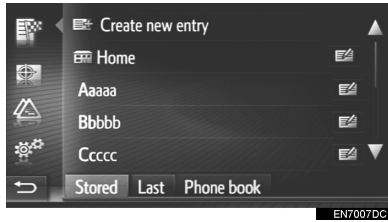

- ▶ The entry options screen of “Stored” list. (When the entry is selected)

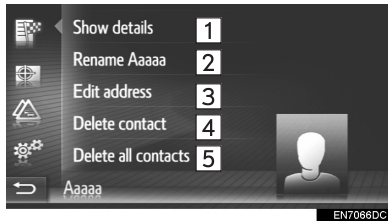

- ▶ The entry options screen of “Stored” list. (When the route is selected)

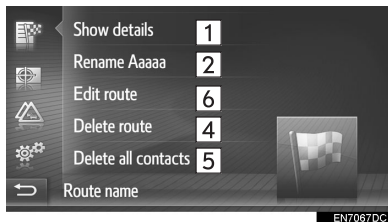

- ▶ The entry options screen of “Last” list

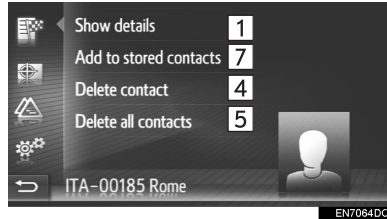

- ▶ The entry options screen of “Phone book” list

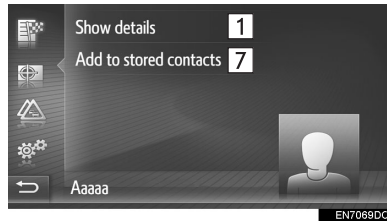

No.	Function	Page
1	Select to display detailed entry information.	217
2	Select to change the entry name.	217
3	Select to edit the address.	217
4	Select to delete the entry/route/destination.	—
5	Select to delete all entries/routes/destinations.	—
6	Select to edit the route.	218
7	Select to register the entry in the “Stored” list on the “My destinations” screen and “Contacts” screen.	213

INFORMATION

- If an entry that is transferred from a cellular phone is edited, the change will affect the entry in the "Stored" list on the "My destinations" screen and "Contacts" screen. (→P.88, 210)

DISPLAYING DETAILS OF THE ENTRY INFORMATION

- 1 Display the entry options screen. (→P.216)
- 2 Select **"Show details"**.
- 3 Check the details of the entry information.



- The address will be marked on the map.
 - The address and a picture, if available, of the contact from the system's phone book will be displayed.
- When **"Go"** is selected, the starting route guidance screen will be displayed.

CHANGING THE ENTRY NAME

- 1 Display the entry options screen. (→P.216)
- 2 Select **"Rename"**.
- 3 Enter the new name and then select **"OK"**.

EDITING THE ADDRESS

- 1 Display the entry options screen. (→P.216)
- 2 Select **"Edit address"**.
- 3 Enter the new address. (→P.190)

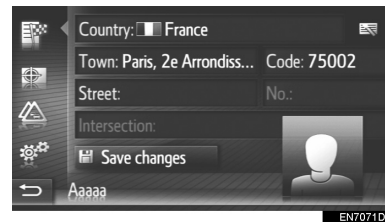

- 4 Select **"Save changes"**.

EDITING THE ROUTE

- 1 Display the entry options screen. (→P.216)
- 2 Select “Edit route”.
- 3 Select  next to the desired entry.



- The order of stopover can be changed by dragging a destination to the desired position.
- 4 Select the desired item.

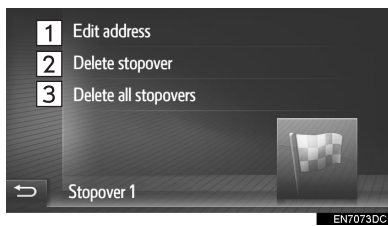

No.	Function
1	Select to edit address. (→P.217)
2	Select to delete stopover.
3	Select to delete all stopovers.

5. MY DESTINATIONS

3. SENDING AND RESTORING STORED CONTACTS USING A USB MEMORY

SENDING STORED CONTACTS TO A USB MEMORY

The entries stored in the “Stored” list on the “My destinations” screen and “Contacts” screen (→P.88, 210) can be transferred to a USB memory.

- 1 Open the cover of the USB/AUX port.

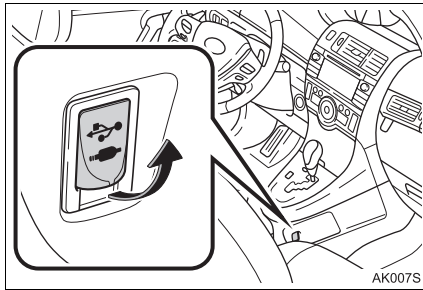

- 2 Connect a USB memory.

- 3 Press the “SETUP” button.

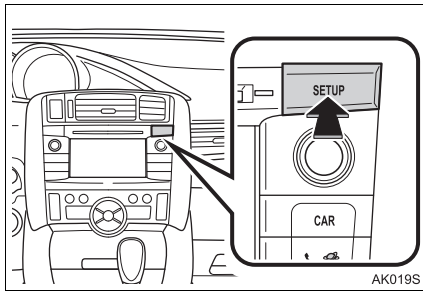

- 4 Select “General”.

- 5 Select “Backup stored contacts to USB”.



- 6 Check that a progress bar is being displayed while the data sending is in progress.

- 7 Check that a confirmation screen is displayed when the operation is complete.

INFORMATION

- Downloading may not complete correctly in the following cases:
 - Vehicles without a smart entry & start system: If the engine switch is turned to the “LOCK” position during downloading.
 - Vehicles with a smart entry & start system: If the engine switch is turned off during downloading.
 - If the USB memory is removed before downloading is complete

RESTORING STORED CONTACTS FROM A USB MEMORY

Backed-up data can be transferred from a USB memory to this system. Transferred entries will be stored in the “Stored” list on the “My Destinations” screen and “Contacts” screen. (→P.88, 210)

- 1 Open the cover of the USB/AUX port.

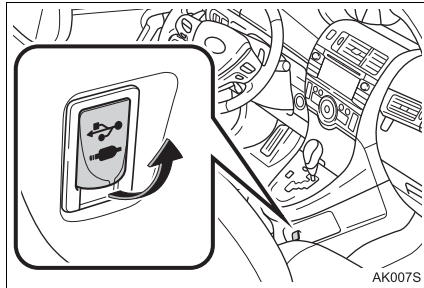

- 2 Connect a USB memory.
- 3 Press the “SETUP” button.

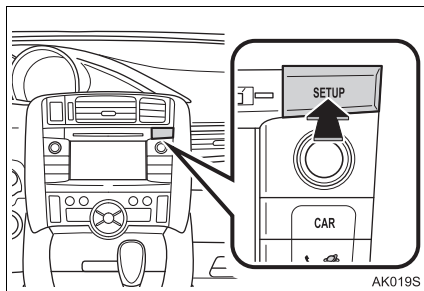

- 4 Select “General”.
- 5 Select “Restore contact backup from USB”.

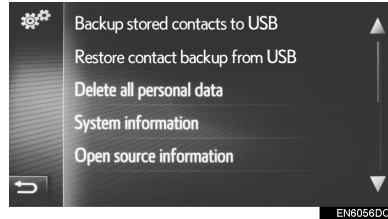

- 6 Check that a progress bar is being displayed while the data loading is in progress.
- 7 Check that a confirmation screen is displayed when the operation is complete.

INFORMATION

- Downloading may not complete correctly in the following cases:
 - Vehicles without a smart entry & start system: If the engine switch is turned to the “LOCK” position during downloading.
 - Vehicles with a smart entry & start system: If the engine switch is turned off during downloading.
 - If the USB memory is removed before downloading is complete

6. NAVIGATION SETTING

1. MAP SETTINGS

SETTING THE MAP

1 Select  on the map.

2 Select “Map settings”.

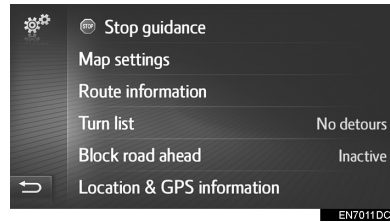

3 Select the item to be set.

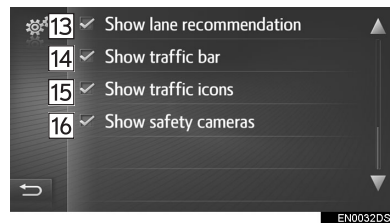
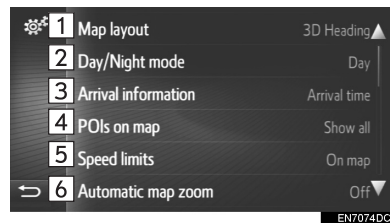

No.	Function	Page
1	Select to set the map layout to 3D heading, 2D heading or 2D north.	179
2	Select to set the screen mode to “Automatic”, “Day” or “Night”.	223
3	Select to set the arrival information display to arrival time, remaining time to the destination, or off.	—
4	Select to set displayed POI icon categories.	222
5	Select to set speed limit information on/off.	223
6	Select to set the automatic zooming function (when approaching a guidance point) on/off.	—
7	Select to set the display of the route guidance arrow with distance to the next maneuver point on/off.	199
8	Select to set the display of the name of the current street or the next street (when approaching a maneuver) on/off.	199
9*	Select to set the display of 3D building icons on or off.	180
10*	Select to set the display of 3D landmark icons on or off.	180
11	Select to set the display of signposts on/off.	199
12	Select to set the display of the junction view on/off.	199
13	Select to set the recommended lane display on/off.	200

6. NAVIGATION SETTING

No.	Function	Page
14	Select to set the traffic bar display on/off.	199
15	Select to set the display of the traffic message icons on/off.	185
16	Select to set the display of the safety cameras icons on/off.	180

*: If equipped

INFORMATION

- The current setting of each item is displayed on its right.

POIs ON MAP

- 1 Display the "Map settings" screen. (→P.221)
- 2 Select "POIs on map".
- 3 Select the desired POI categories.

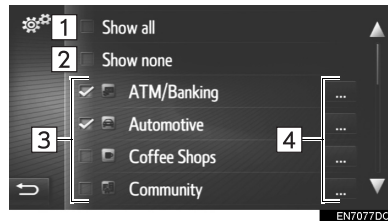

No.	Function
1	Select to display all categories.
2	Select to hide all icons.
3	Select to select main categories.
4	Select to select subcategories.

DAY/NIGHT MODE

- 1 Display the “Map settings” screen. (→P.221)
- 2 Select “**Day/Night mode**”.
- 3 Select the desired item.

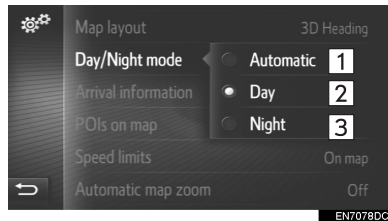

No.	Function
1	Select to change the screen to day or night mode depending on the position of the headlight switch.
2	Select to always display the map in day mode.
3	Select to always display the map in night mode.

SPEED LIMITS

- 1 Display the “Map settings” screen. (→P.221)
- 2 Select “**Speed limits**”.
- 3 Select the desired item.

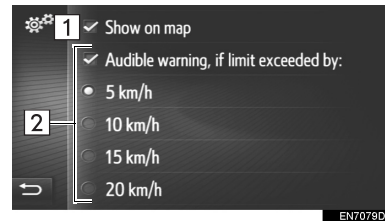

No.	Function
1	Select to display the speed limits on the map.
2	Select to receive an audible warning, if the speed limit will be exceeded by a certain range.

6. NAVIGATION SETTING

2. ROUTE SETTINGS

SETTING THE ROUTE OPTIONS

SETTING THE ROUTE CALCULATION

- 1 Display the “Navigation” menu screen and select “Route options”. (→P.173)
- 2 Select the “Preferences” tab.
- 3 Select the desired item.

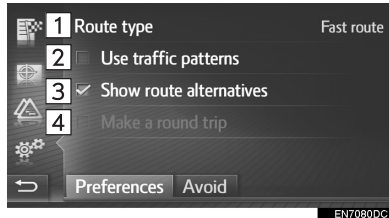

No.	Function
1	Select to select “Fast route”, “Short route” or “Ecological route” route type.
2	Select to include the traffic information history in the route calculation.
3	Select to display the 3 routes (fastest, shortest and ecological) on the map after route calculation.
4	Select to have the route automatically calculated back to the starting point after the set destination has been reached. Entered stopovers will also be considered on the way back to the starting point.

INFORMATION

- “Show route alternatives” and “Make a round trip” are not selectable at the same time.

SETTING THE AVOIDANCE CRITERIA FOR THE ROUTE CALCULATION

- 1 Display the “Navigation” menu screen and select “Route options”. (→P.173)
- 2 Select the “Avoid” tab.
- 3 Select the desired item.

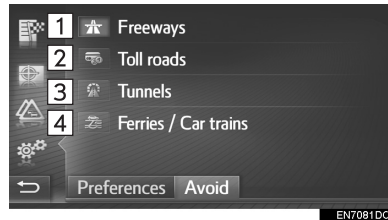

No.	Function
1	Select to avoid motorways.
2	Select to avoid toll roads.
3	Select to avoid tunnels.
4	Select to avoid ferries and car trains.

6. NAVIGATION SETTING

3. TRAFFIC MESSAGE SETTINGS

TRAFFIC MESSAGE SETTINGS

- 1 Display the “Navigation” menu screen and select “**Traffic messages**”. (→P.173)
- 2 Select the “**Settings**” tab.
- 3 Select the desired item.

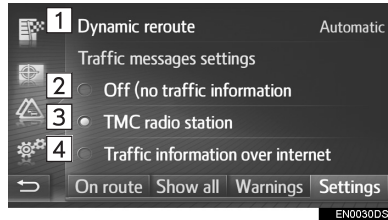

No.	Function	Page
1	Select to set the reroute method.	225
2	Select to turn off traffic message.	—
3	Select to receive traffic information via the TMC radio station.	226
4	Select to receive traffic information via the internet.	227

SETTING REROUTE METHOD

- 1 Display the “Settings” screen. (→P.225)
- 2 Select “**Dynamic reroute**”.
- 3 Select the desired item.

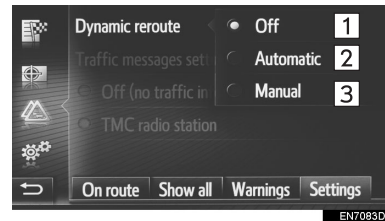

No.	Function
1	Select to disable receiving traffic messages and no reroute will be calculated.
2	Select to enable relevant traffic messages on the route to be displayed as a pop-up window and activate automatic reroute calculation.
3	Select to enable relevant traffic messages on the route to be displayed as a pop-up window but disable automatic reroute calculation. The user decides if reroute calculation is desirable or not.

RECEIVING TRAFFIC INFORMATION VIA THE TMC RADIO STATION

- 1 Display the “Settings” screen. (→P.225)
- 2 Select “TMC radio station”.
- 3 Select the desired item.

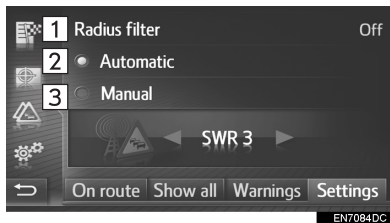

No.	Function
1	Select to set the radius for displaying traffic messages.
2	Select to allow the system to automatically tune to a TMC station with the best reception.
3	Select to manually tune to a TMC station. Select ◀ or ▶ when these buttons are made available.

INFORMATION

- When the manually tuned station can no longer be received, the station with the best reception is selected by the system and the manually tuned station will be dimmed. Once the manually tuned station can be received again, it will be used as the TMC station.

SETTING RADIUS FILTER

- 1 Select “Radius filter”.
- 2 Select desired item.

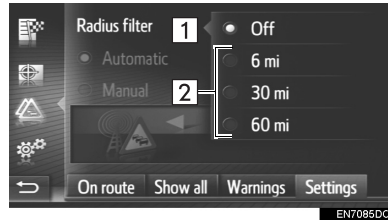

No.	Function
1	Select to deactivate the function.
2	Select to set the radius from 10 km to 100 km (6 miles to 60 miles).

RECEIVING TRAFFIC INFORMATION VIA THE INTERNET

- 1 Display the “Settings” screen. (→P.225)
- 2 Select “Traffic information over internet”.
- 3 Select the desired item.

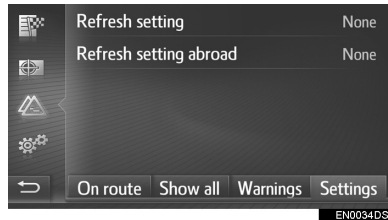

“**Refresh setting**”: Refreshing of traffic information via the internet when the vehicle is in your home country.

“**Refresh setting abroad**”: Refreshing of traffic information via the internet while the vehicle is abroad.

- 4 Select the desired item.

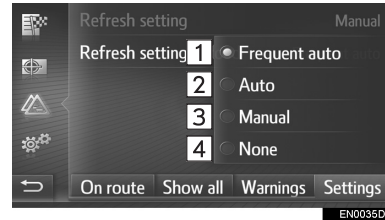

No.	Function
1	Select to update automatically every 3 minutes.
2	Select to update automatically every 6 minutes.
3	Select to update manually.
4	Select to turn off updates.

7. NAVIGATION SYSTEM INFORMATION

1. LIMITATIONS OF THE NAVIGATION SYSTEM

This navigation system calculates the current vehicle position using satellite signals, various vehicle signals, map data, etc. However, an accurate position may not be shown depending on satellite condition, road configuration, vehicle condition or other circumstances.

The Global Positioning System (GPS) developed and operated by the U.S. Department of Defense provides an accurate current vehicle position, normally using 4 or more satellites, and in some case 3 satellites. The GPS system has a certain level of inaccuracy. While the navigation system will compensate for this most of the time, occasional positioning errors of up to 100 m (300 feet) can and should be expected. Generally, position errors will be corrected within a few seconds.



The GPS signal may be physically obstructed, leading to inaccurate vehicle position on the map display. Tunnels, tall buildings, trucks, or even the placement of objects on the instrument panel may obstruct the GPS signals.

The GPS satellites may not send signals due to repairs or improvements being made to them.

Even when the navigation system is receiving clear GPS signals, the vehicle position may not be shown accurately or inappropriate route guidance may occur in some cases.

NOTICE

- The installation of window tinting may obstruct the GPS signals. Most window tinting contains some metallic content that will interfere with GPS signal reception of the antenna. We advise against the use of window tinting on vehicles equipped with navigation systems.
- Accurate current vehicle position may not be shown in the following cases:
 - When driving on a small angled Y-shaped road.
 - When driving on a winding road.
 - When driving on a slippery road such as in sand, gravel, snow, etc.
 - When driving on a long straight road.
 - When motorway and surface streets run in parallel.
 - After moving by ferry or vehicle carrier.
 - When a long route is searched during high speed driving.
 - When driving without setting the current position calibration correctly.
 - After repeating a change of direction by going forward and backward, or turning on a turntable in the parking lot.
 - When leaving a covered parking lot or parking garage.
 - When a roof carrier is installed.
 - When driving with tyre chains installed.
 - When the tyres are worn.
 - After replacing a tyre or tyres.
 - When using tyres that are smaller or larger than the factory specifications.
 - When the tyre pressure in any of the four tyres is not correct.

- Inappropriate route guidance may occur in the following cases:
 - When turning at an intersection off the designated route guidance.
 - If you set more than one destination but skip one of them, auto reroute will display a route returning to the destination that was skipped.
 - When turning at an intersection for which there is no route guidance.
 - When passing through an intersection for which there is no route guidance.
 - During auto reroute, the route guidance may not be available for the next turn to the right or left.
 - It may take a long time to operate auto reroute during high speed driving. In auto reroute, a detour route may be shown.
 - After auto reroute, the route may not be changed.
 - An unnecessary U-turn may be shown or announced.
 - A location may have multiple names and the system will announce one or more.
 - Some routes may not be searched.
 - If the route to your destination includes gravel, unpaved roads or alleys, the route guidance may not be shown.
 - Your destination point might be shown on the opposite side of the street.
 - When a portion of the route has regulations prohibiting the entry of the vehicle that vary by time or season or other reasons.
 - The road and map data stored in the navigation system may not be complete or may not be the latest version.

INFORMATION

- This navigation system uses tyre turning data and is designed to work with factory-specified tyres for the vehicle. Installing tyres that are larger or smaller than the originally equipped diameter may cause inaccurate display of the current vehicle position. The tyre pressure also affects the diameter of the tyres so make sure the tyre pressure of all four tyres is correct.

7. NAVIGATION SYSTEM INFORMATION

2. NAVIGATION DATABASE UPDATES

UPDATING NAVIGATION DATABASE

Navigation database which contains system software, map data, Gracenote database, etc., can be updated using a USB memory.

For details, contact Toyota dealer or refer to Toyota portal site (www.my.toyota.eu).

- 1 Open the cover of the USB/AUX port.

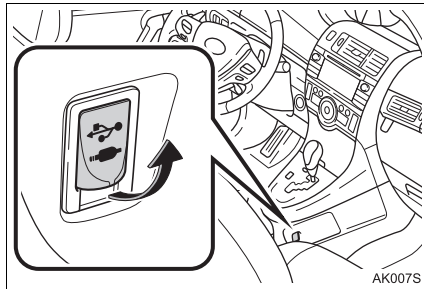

- 2 Connect a USB memory.
- 3 Select **“Yes”** when the confirmation screen appears.
- 4 Enter license key.
 - If the license key is invalid, the navigation database will not be updated.
- 5 Select **“Confirm”**.
- 6 Check that the updating screen is displayed.

INFORMATION

- Updating may not complete correctly in the following cases:
 - Vehicles without a smart entry & start system: If the engine switch is turned to the “LOCK” position during updating.
 - Vehicles with a smart entry & start system: If the engine switch is turned off during updating.
 - If the USB memory is removed before updating is complete
- The amount of time required to complete the update process depends on the size of the data.

9

APPLICATION

1 APPLICATIONS OPERATION	2 CONNECTED SERVICE
1. QUICK REFERENCE 232	1. CONNECTED SERVICE OVERVIEW..... 244
2. PICTURE SLIDESHOW 235 DISPLAYING THE PICTURES 235 OPERATING A PICTURE SLIDESHOW 236	2. BEFORE USING CONNECTED SERVICE 248 OBTAINING A PORTAL SITE ACCOUNT 248 LOGIN PROCESS CONNECTED SERVICES 249
3. E-MAIL 237 RECEIVING AN E-MAIL 237 CHECKING E-MAIL 238	3. ONLINE SEARCH 251 ONLINE SEARCH 251 VIEWING POI* DETAILS 254 SELECTING A SEARCH ENGINE 255
4. CALENDAR..... 239 CHECKING CALENDAR 239	4. Street View 256
5. MirrorLink™ 241	5. Panoramio..... 257
6. TOYOTA EUROCARE 242 REGISTERING A COUNTRY 242 USING THE TOYOTA EUROCARE 243	6. LOADING POIs*/ROUTE 258 DOWNLOADING VIA A CELLULAR PHONE 258 DOWNLOADING FROM A USB MEMORY 258
	7. OPERATING AN APPLICATION USING CONNECTED SERVICE 259 DOWNLOADING AN APPLICATION TO THE SYSTEM 259 OPERATING AN APPLICATION 260

Not all connected services may be available in all countries.

Some of the functions cannot be operated while driving.



*: Point of Interest

1. APPLICATIONS OPERATION

1. QUICK REFERENCE

The applications can be accessed by pressing the  button.

Each time the  button is pressed, the screen will change between the "Phone" menu screen and the "Extras"/"Toyota online" menu screen.

When the  button is pressed, the screen that was last displayed is returned to. Select  to display the "Extras"/"Toyota online" menu screen.

► Multimedia system

■ "Extras" MENU SCREEN

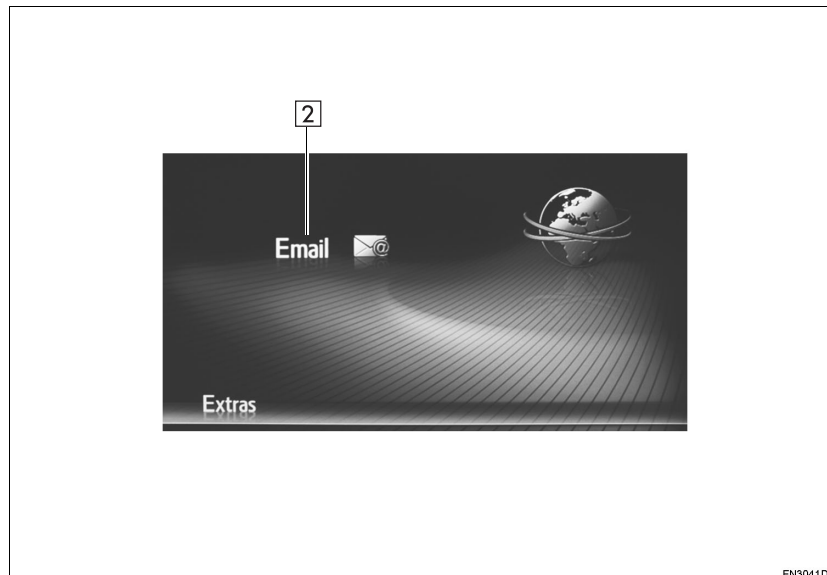

► Navigation system

■ “Toyota online” MENU SCREEN

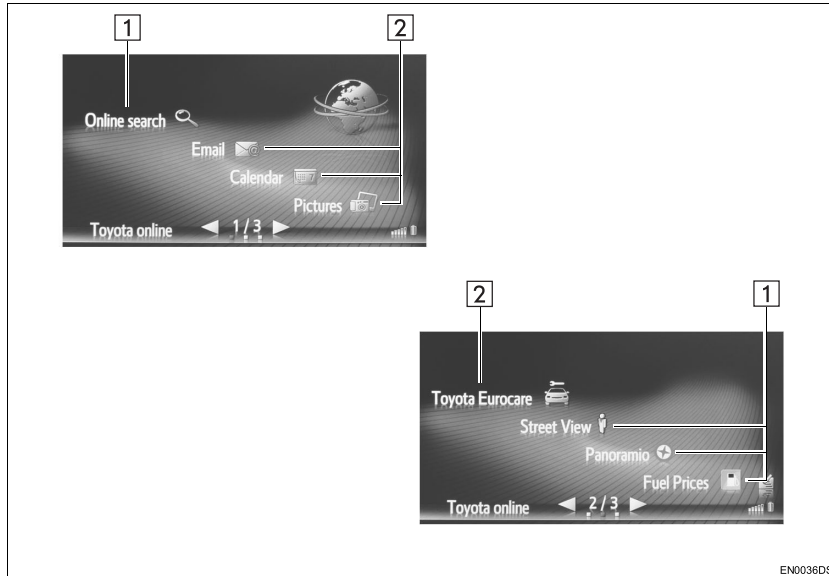

EN0036DS

1. APPLICATIONS OPERATION

No.	Function	Application	Page
1*1	Select to access connected service. (→P.244)	Online search	251
		Street View	256
		Panoramio	257
		Downloadable applications	259
2	Select to access pre-installed applications.	Pictures*1	235
		Email	237
		Calendar*2	239
		MirrorLink™	241
		Toyota Eurocare*1	242

*1: Navigation system only

*2: If equipped

INFORMATION

- The shown screen in the illustrations may differ from your vehicle's screen in terms of equipment.

1. APPLICATIONS OPERATION

2. PICTURE SLIDESHOW*

Pictures stored on a USB memory can be viewed.

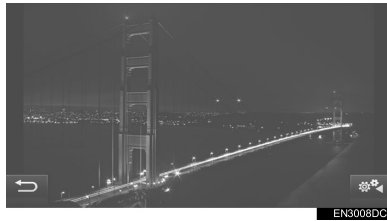

INFORMATION

- This function is not available while driving.
- When the vehicle starts moving while viewing pictures, a pop-up window will be displayed and pictures cannot be displayed. Select **“Leave function”** to return to the “Toyota online” menu screen.
- Available image data format: JPEG, PNG and BMP

DISPLAYING THE PICTURES

- 1 Open the cover of the USB/AUX port.

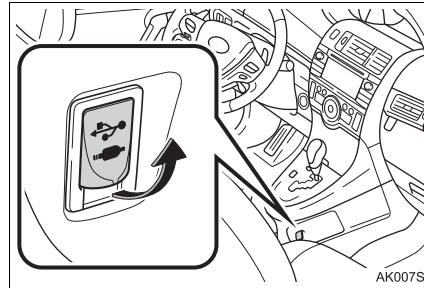

- 2 Connect a USB memory.
 - 3 Display the “Toyota online” menu screen. (→P.232)
 - 4 Select **“Pictures”**.
- The slideshow starts automatically.

INFORMATION

- All readable pictures on the device are displayed in chronological order. The slideshow will repeat when it is finished.
- The pictures will be changed every few seconds.

9

APPLICATION

*: Navigation system only

OPERATING A PICTURE SLIDESHOW

A slideshow can be played, paused, and desired images can be selected.

- 1 Select .

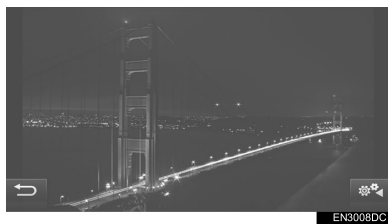

- 2 Check that the operating switches are displayed.



No.	Function
1	Select to display the previous/ next picture.
2	Select to pause the slideshow. Select  to play the slideshow again.
3	Select to close the operating switches.

INFORMATION

- When the slideshow is playing, the pause and skip screen buttons disappear automatically after a few seconds.

1. APPLICATIONS OPERATION

3. E-MAIL

Incoming e-mails to a connected Bluetooth® phone can be downloaded. Before using this application, connect a Bluetooth® phone with a phone profile. (→P.125, 132)

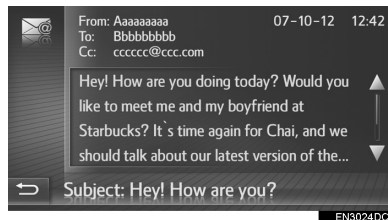

INFORMATION

- This function may not be available depending on the phone.
- E-mails cannot be sent using this function.
- Downloading may not complete correctly in the following cases:
 - Vehicles without a smart entry & start system: If the engine switch is turned to the "LOCK" position during downloading.
 - Vehicles with a smart entry & start system: If the engine switch is turned off during downloading.

RECEIVING AN E-MAIL

When a new e-mail is received, a pop-up window is displayed on the screen.

- 1 Select "Show" to check the e-mail.
- 2 Check that the e-mail is displayed.

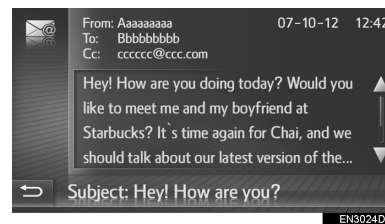

INFORMATION

- This function can be set to on or off. (→P.148)

CHECKING E-MAIL

- 1 Display the “Extras”/“Toyota online” menu screen. (→P.232)
- 2 Select “Email”.
 - When the downloading of an e-mail has been completed, the mail list will be displayed.
- 3 Select the desired e-mail.

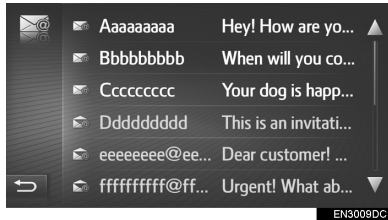





- The state of an e-mail is shown by the following icons.

 : Unread mail

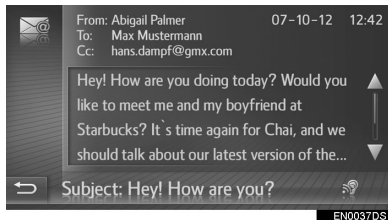
 : Read mail

- 4 Check that the message is displayed.



-  (If equipped):
When  is selected, the Email message is read out. To cancel this function, select .

1. APPLICATIONS OPERATION

4. CALENDAR*

Calendar entries, tasks and notes from a connected Bluetooth® phone can be downloaded. Before using this application, connect a Bluetooth® phone with a phone profile. (→P.132)

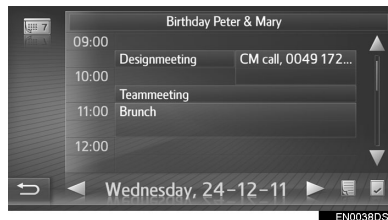

INFORMATION

- This function may not be available depending on the phone.
- Calendar entries cannot be edited using this function.
- Downloading may not complete correctly if the engine switch is in the following status during downloading.

▶ Vehicles without a smart entry & start system

The engine switch is turned to the "LOCK" position.

▶ Vehicles with a smart entry & start system

The engine switch is turned off.

CHECKING CALENDAR

- 1 Display the "Toyota online" menu screen. (→P.232)
- 2 Select "Calendar".



- When the downloading of the calendar is complete, the current day's calendar entries will be displayed.

9

APPLICATION

*: If equipped

1. APPLICATIONS OPERATION

- 3** When a displayed schedule entry is selected, the entry's detailed information is displayed.

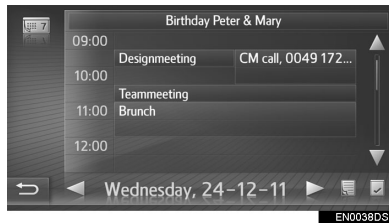

: Select to display the previous day's schedule.

: Select to display the following day's schedule.

: Select to display the current day's tasks.

: Select to display the notes.

1. APPLICATIONS OPERATION

5. MirrorLink™

When a MirrorLink™ compatible device is connected via USB, a MirrorLink™ screen is displayed on the navigation/multimedia system display. The MirrorLink™ device can be operated via navigation/multimedia system.

- 1 Open the cover of the USB/AUX port.

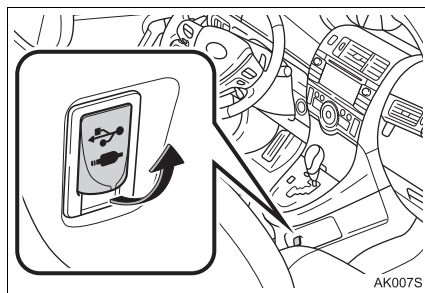

- 2 Connect a MirrorLink™ device.
 - Only one MirrorLink™ device can be connected at a time.
- 3 Display the “Extras”/“Toyota online” menu screen. (→P.232)
- 4 Select a desired application, when available MirrorLink™ applications are displayed.
 - The MirrorLink™ application display may be different than shown depending on the connected MirrorLink™ device or application.
- 5 Check that a confirmation screen is displayed and then select “**Confirm**”.

INFORMATION

- This function may not be available depending on the device.

1. APPLICATIONS OPERATION

6. TOYOTA EURO CARE*

This feature is used to make a call to Toyota Eurocare service.

Before using this function, connect a Bluetooth® phone with a phone profile. (→P.132)

REGISTERING A COUNTRY

- 1 Display the “Toyota online” menu screen. (→P.232)
- 2 Select “Toyota Eurocare”.
- 3 Select the country.



- 4 Check that the country is displayed on the screen.

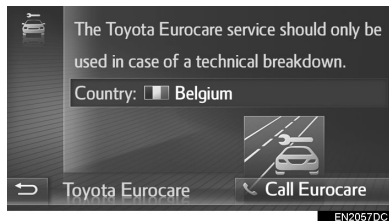

CHANGING A COUNTRY

- 1 Display the “Toyota online” menu screen. (→P.232)
- 2 Select “Toyota Eurocare”.
- 3 Select the registered country.

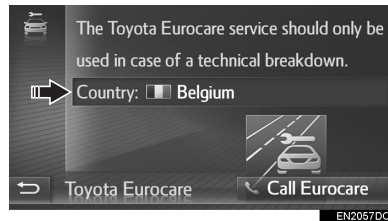

- 4 Select another country to replace the existing country.



- 5 Check that the country is displayed on the screen.

*: Navigation system only

USING THE TOYOTA EURO CARE

- 1 Display the “Toyota online” menu screen. (→P.232)
- 2 Select “Toyota Eurocare”.



- 3 Select “Call Eurocare”.

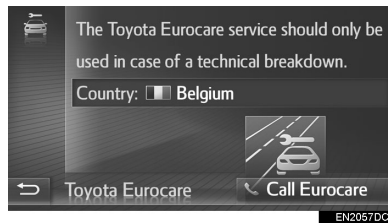

- 4 Select “Yes” when the confirmation screen appears.

- 5 Check that the following screen will be displayed.

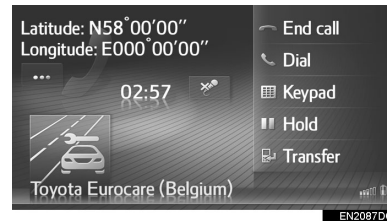

- The geographic coordinates of the current location will be displayed at the top-left corner of the screen.
- When “...” appears on the screen, select to display the following position details.
On freeways: Freeway number, driving direction and next exit.
On other roads: Address information.
Each time “...” is selected, the screen changes between the geographical coordinates and position details.

INFORMATION

- The call must be placed in a country where Toyota Eurocare service is available.

2. CONNECTED SERVICE

1. CONNECTED SERVICE OVERVIEW*

The following services are available by connecting the navigation system to Toyota portal site via the internet using a cellular phone or Wi-Fi® network*1.

- Online search: New establishments, such as restaurants, bars etc., that are not registered in the navigation system can be set as a destination.
- Importing memory points and routes: Establishments that were searched using a computer can be set as a destination and can be registered in the “Stored” list on the “My destinations” screen. (→P.210)
- Vehicle customisation: Some vehicle settings can be changed via the connected services, by vehicle’s settings data to and from the Toyota portal site. (→P.146)
- Street View: The Street View of the desired location can be viewed.
- Panoramio: The available pictures on the network, comments and other information can be viewed.
- Downloadable application: Various functions can be added by downloading applications using a USB memory.

► Online search/Street View/Panoramio

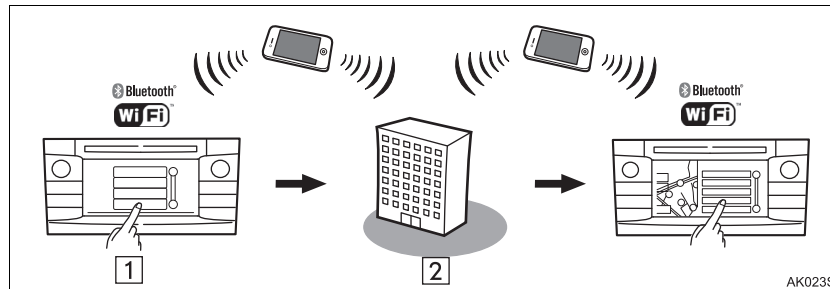

No.	Name	Operation
1	Navigation system	Enter a keyword.
2	Toyota portal site*2/ Contents provider	The keyword is sent to the search engine, the results are received and sent to the navigation system.

*1: If equipped

*2: For details about Toyota portal site, refer to www.my.toyota.eu.

*: Navigation system only

► Importing memory points and routes: Downloading via a cellular phone

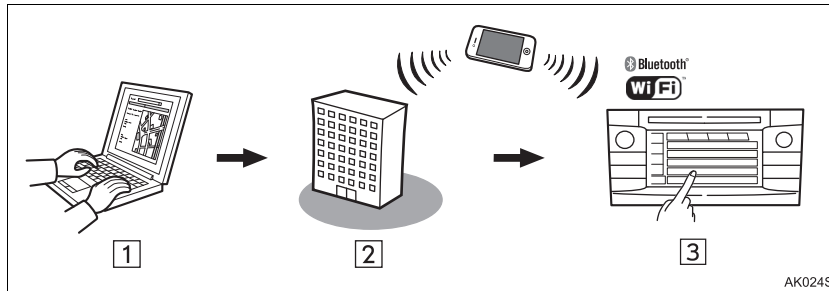

► Importing memory points and routes: Downloading from a USB memory

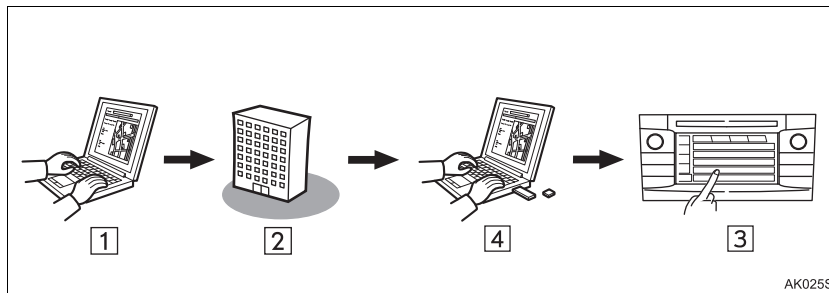

No.	Name	Operation
1	Your personal computer and Toyota portal site*	Access the portal site and search POIs and routes.
2	Toyota portal site*	The POIs and routes are saved at Toyota portal site.
3	Navigation system	Via the internet, the POIs and routes are downloaded to the navigation system. Via the USB the POIs and routes are downloaded to the navigation system.
4	USB memory	The POIs and routes are saved to a USB.

*: For details about Toyota portal site, refer to www.my.toyota.eu.

2. CONNECTED SERVICE

► Vehicle customisation: Sending vehicle's settings data to and from the Toyota portal site

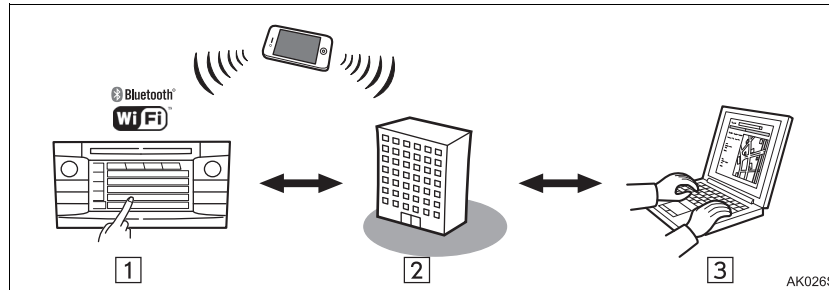

No.	Name	Operation
1	Navigation system	Via the internet, the vehicle's settings are sent to/receive from the Toyota portal site.
2	Toyota portal site*	The vehicle's settings are saved at Toyota portal site.
3	Your personal computer and Toyota portal site*	Access the portal site and change the vehicle's settings.

*: For details about Toyota portal site, refer to www.my.toyota.eu.

► Downloadable application

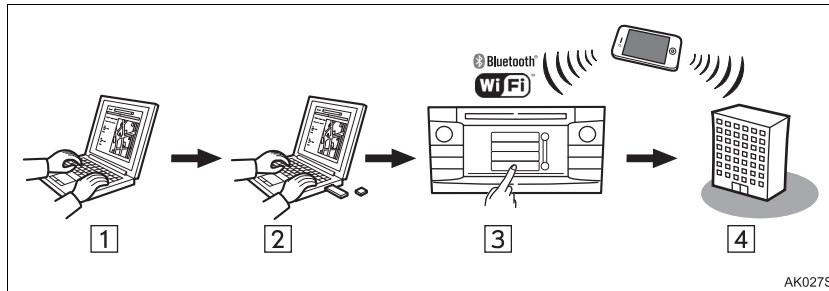

No.	Name	Operation
1	Your personal computer and Toyota portal site*	Access the portal site and download application.
2	USB memory	The downloaded application is saved to a USB.
3	Navigation system	Via the USB the application is downloaded to the navigation system. Runs applications on the navigation system.
4	Contents provider	Contents received via a cellular phone.

*: For details about Toyota portal site, refer to www.my.toyota.eu.

2. CONNECTED SERVICE

2. BEFORE USING CONNECTED SERVICE*

OBTAINING A PORTAL SITE ACCOUNT

Before using connected services, it is necessary to first access Toyota portal site (www.my.toyota.eu) via a personal computer and create an account.

Vehicle Identification Number (VIN) is required to obtain an account from the navigation system. For details on the Vehicle Identification Number, refer to “*Owner’s manual*”.

- In order to use this service, a Bluetooth® DUN/PAN capable cellular phone with a valid data plan subscription is required.
- When using the connected services, depending on your phone subscription, some related fees might apply.
- When a cellular phone is used in a roaming situation (when outside the geographical coverage area of mobile network provider) connection fees will be more expensive.

CHECKING DEVICE IDENTIFICATION

- 1 Press the “**SETUP**” button.

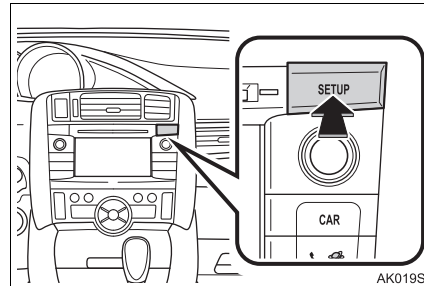

- 2 Select “**General**”.

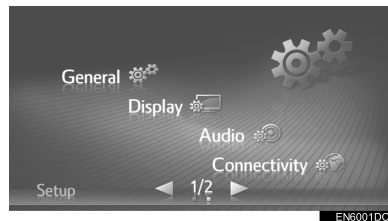

- 3 Select “**System information**”.



*: Navigation system only

4 Check that the device ID is displayed.

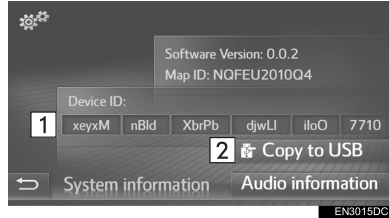

No.	Function
1	Displays the device ID
2	Select to copy system information to the USB memory.

**LOGIN PROCESS
CONNECTED SERVICES**

Before using connect services, connect a Bluetooth® phone with an internet profile. (→P.132)

1 Activate any connected service.

How to activate connected service	Page
Online search	251
Street View	256
Panoramio	257
Loading POIs/Routes	258
Downloaded application	259
Vehicle customisation	146

- When the cost warning or roaming warning screen is displayed, select “**Continue**”. This function can be set to on or off. (→P.141)

2 Select “**Username**”.

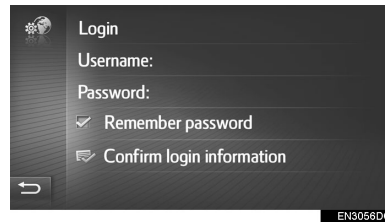

3 Input the server username and then select “**OK**”.

4 Select “**Password**”.

5 Input the server password and then select “**OK**”.

9

APPLICATION

6 Select “**Confirm login information**”.

- When “**Remember password**” is on, the entered user login information will be remembered for every login.
- If the account already has 5 cars registered, it is not possible to register another car.

2. CONNECTED SERVICE

3. ONLINE SEARCH*

ONLINE SEARCH

A destination can be selected via connected service.

Online search will not be available in all countries.

- 1 Display the “Toyota online” menu screen. (→P.232)
- 2 Select “**Online search**”
 - Online search can be entered on the “POI” screen. (→P.191)
- 3 Select to select the desired search engine.
 - If there is more than one online search engine available, these engines will be displayed.
 - The desired online search engine can be changed. (→P.255)

- 4 Select the desired search area.

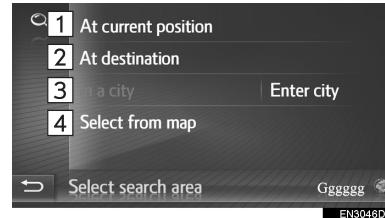

No.	Function
1	Select to set a location around the current position.
2	Select to set the location around the main destination.
3	Select to set the desired city. Select “ Enter city ” to enter the city name and then select “ OK ”.
4	Select to set a location by using a point on the map. Select the desired point on the map and then select “ Select ”.

- 5 Enter the search word and then select “**OK**”.



- : Select to enter keywords from previously set keywords list. (→P.253)

9

APPLICATION

*: Navigation system only

2. CONNECTED SERVICE

- 6** Check that the search results is displayed. Select the desired item.

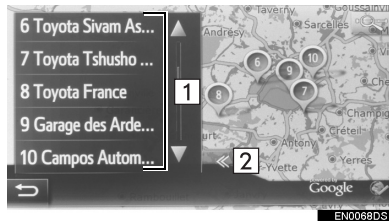

No.	Function
1	Search results <ul style="list-style-type: none"> • Up to 20 search results are downloaded at a time. • Highlighted advertisements may be displayed at the top of the search result list.
2	Select to display a full screen map.

- At the end of the list “**Download more**” will be shown. Select “**Download more**” to search up to 20 new items.
 - “**Download more**” will not be shown if the list includes only less than 20 entries.
 - Select “**Previous results**” to display the previous result.

- 7** Select “Go”.



No.	Function	Page
1	Select to display the detailed information.	254
2	Select to call the registered telephone number.	90
3	Select to display the Street View.	256

- The route will be recalculated.

INFORMATION

- After establishments acquired using “Online search” have been set as a destination once, they will be stored in the “Stored” list on the “My Destinations” screen.

ENTERING KEYWORDS FROM THE LIST

Search can be again started from the history of a search word.
The maximum number of search word history is 10.

- 1 Select  on the search word entering screen.
- 2 Select the desired word.

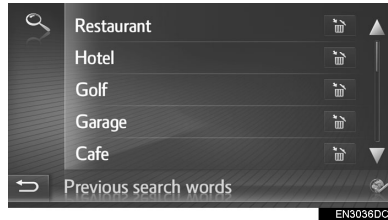

- 3 Select "OK".

DELETE SEARCH WORDS HISTORY

- 1 Select .
- 2 Select the desired item.

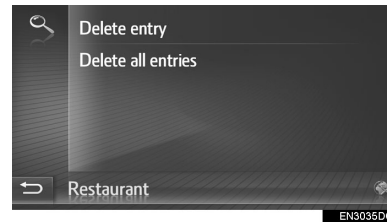

- 3 Select "Yes".

2. CONNECTED SERVICE

VIEWING POI DETAILS

- 1 Select  on the POI information screen.
- 2 Check that the details of the selected POI are displayed.

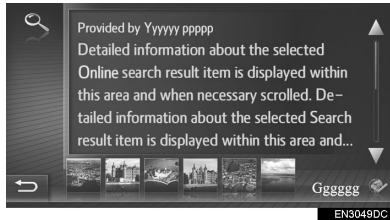

- Select the desired picture to display full screen. (if available)

RATING POI INFORMATION

Your rating of the selected POI can be submitted. If the information is incorrect, you can notify the search provider by selecting the appropriate button. This function may not be available depending on the search provider.

- 1 Display the last page of POI information and select **“Provide feedback about POI”**.



- 2 Check that the following screen is displayed.

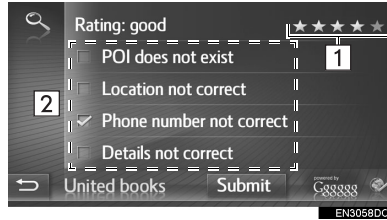

No.	Function
1	Select to enter your rating.
2	Select to notify the search provider of incorrect information.

- 3 Select **“Submit”**.

SELECTING A SEARCH ENGINE

Throughout the entire search process it is possible to change the search engine by selecting on the logo of the current search engine.

1 Select the search engine logo.





- A list of available other search engine is shown.

2 Select the desired search engine.

- After selection of one of the search engine the search process starts from beginning with this provider.
- If there are no other search engines available, selecting the search engine logo will have no effect.

INFORMATION

-  or : Indicates if online connection is active or not. After a timeout of 1 minute, an active online connection will automatically be terminated.

2. CONNECTED SERVICE

4. Street View*

The Street View of the desired location can be viewed.

- 1 Display the “Toyota Online” menu screen. (→P.232)
- 2 Select “**Street View**”.

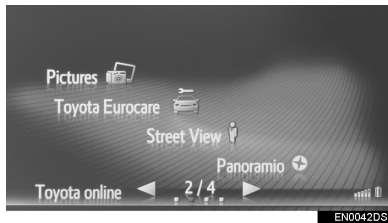

- 3 Select the desired item to search a location.

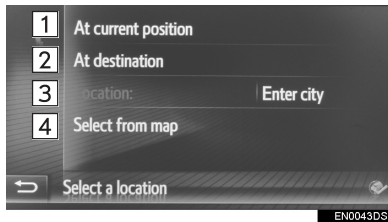

No.	Function
1	Select to set a location by using the current position.
2	Select to set the location around the main destination.
3	Select to set the desired location. Select “ Enter location ” to enter house number, street, town or place name and then select “ OK ”.
4	Select to set a location by using a point on the map. Select the desired point on the map.

- 4 Check that the picture is displayed.

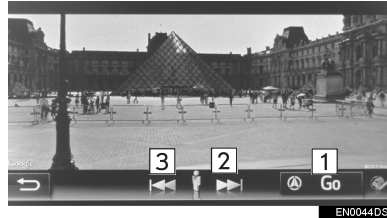

No.	Function
1	Select to calculate the route.
2	Select to display the next picture.
3	Select to display the previous picture.

- Up to 6 pictures per location can be displayed.

INFORMATION

- The Street View function can also be selected from the following screens:
 - Starting route guidance screen (→P.196)
 - Online search result screen (→P.251)
- This function is not available while driving.

*: Navigation system only

2. CONNECTED SERVICE

5. Panoramio*

The available pictures on the network, comments and other information can be viewed.

- 1 Display the “Toyota Online” menu screen. (→P.232)
- 2 Select “Panoramio”.

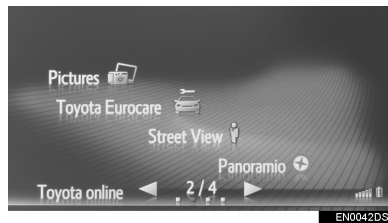

- 3 Select the desired item to search a point.

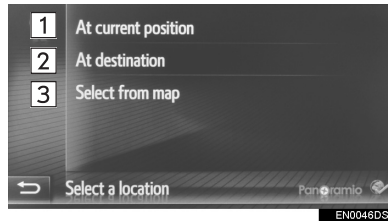

No.	Function
1	Select to set a location by using the current position.
2	Select to set the location around the main destination.
3	Select to set a location by using a point on the map.

- 4 Select the desired picture.

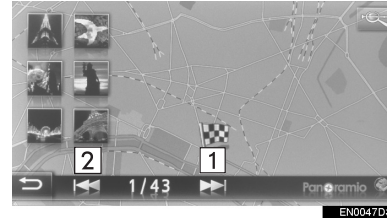

No.	Function
1	Select to display the next picture.
2	Select to display the previous picture.

- Can scroll the map to the desired point.

- 5 Check that a picture is displayed.

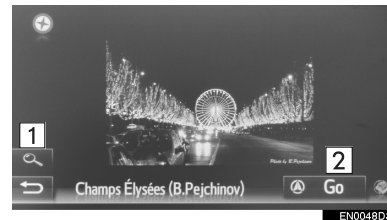

No.	Function
1	Select to display detailed information of the selected point.
2	Select to calculate the route.

INFORMATION

- This function is not available while driving.

9

APPLICATION

*: Navigation system only

2. CONNECTED SERVICE

6. LOADING POIs/ROUTE*

POIs and routes can be added by downloading from the Toyota portal site. They will be stored in the “Stored” list on the “My destinations” screen. (→P.210)

DOWNLOADING VIA A CELLULAR PHONE

- 1 Display the “Navigation” menu screen and select “Enter destination”. (→P.173)
- 2 Select the “Advanced” tab.
- 3 Select “Load POIs and routes from server”.

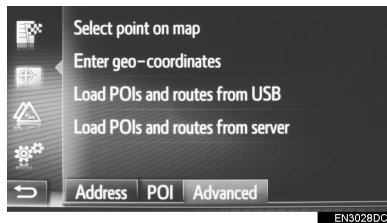

- 4 Check that a loading the data screen is displayed.
 - 5 Check that a confirmation screen is displayed when the operation is complete.
- The entry is registered in the “Stored” list on the “My destinations” screen. (→P.210)

INFORMATION

- Downloading may not complete correctly in the following cases:
 - Vehicles without a smart entry & start system: If the engine switch is turned to the “LOCK” position during downloading.
 - Vehicles with a smart entry & start system: If the engine switch is turned off during downloading.
- If the “Automatic download of POIs and routes” function is on, POIs and routes from the server will be downloaded automatically. (→P.146)
- If the maximum number of possible stored contacts has been reached, a confirmation screen appears. Delete contact(s) to make room for new contact(s). (→P.85, 216)

DOWNLOADING FROM A USB MEMORY

For details about downloading from a USB memory. (→P.214)

*: Navigation system only

2. CONNECTED SERVICE

7. OPERATING AN APPLICATION USING CONNECTED SERVICE*

DOWNLOADING AN APPLICATION TO THE SYSTEM

To download an application, a USB memory that contains the application data is required. For details about an application, refer to Toyota portal site (www.my.toyota.eu).

- 1 Open the cover of the USB/AUX port.

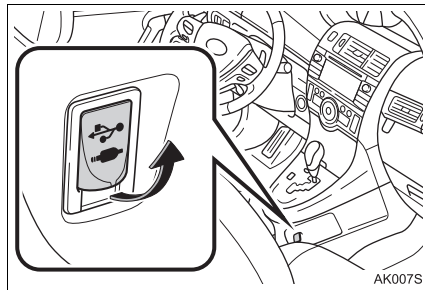

- 2 Connect a USB memory.
- 3 Select **“Yes”** when the confirmation screen appears.
- 4 Select **“Enter Key”** and then enter the license key.
 - If the license key is invalid, the application will not be downloaded.
- 5 Select **“Confirm”**.
- 6 Check that the updating screen is displayed.

INFORMATION

- Downloading may not complete correctly in the following cases:
 - Vehicles without a smart entry & start system: If the engine switch is turned to the “LOCK” position during downloading.
 - Vehicles with a smart entry & start system: If the engine switch is turned off during downloading.
 - If the USB memory is removed before downloading is complete

9

APPLICATION

*: Navigation system only

OPERATING AN APPLICATION

For details about operating the downloaded application, refer to www.my.toyota.eu.

- 1 Display the “Toyota online” menu screen. (→P.232)
- 2 Select the desired application.

SETTING AN APPLICATION

- 1 Display the “Toyota online” menu screen. (→P.232)
- 2 Select  next to the desired application.

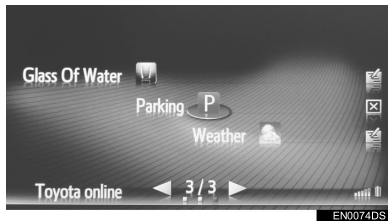

- Select  to close the application.

- 3 Check that the application option screen is displayed.

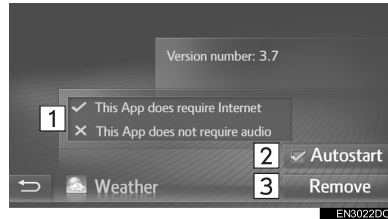

No.	Function
1	Displays information about the application.
2	If the check box has been activated, application will be started automatically after this system turn on.
3	Select to delete the application.

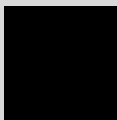

INDEX

1

2

3

4

5

6

7

8

9

ALPHABETICAL INDEX

A

AAC	36, 70, 72
Adding and editing stopovers	203
Address	190
AF (Alternative frequency).....	32
AM	28
Application	232
Arrival time.....	199
Audio	24
Basic operation	25
Inserting or ejecting a disc	26
Switching audio source	26
System on/off.....	25
USB/AUX port	27
Audio operating information.....	65
CD player and discs.....	68
CD-R and CD-RW discs	72
File (audio).....	70
iPod.....	67
Radio.....	65
Terms.....	72
Audio settings	149
AUX	53
Control panel/screen.....	53
AUX port	27
Average speed	115

B

Before using connected service.....	248
Login process.....	249
Portal site account.....	248
Blocking road ahead	206
Bluetooth®	56, 75, 125, 132
Bluetooth® audio.....	56
Connecting.....	60
Control panel/screen	56
Listening.....	61
Options.....	61
Bluetooth® phone	76
Bluetooth® settings	125, 132
Function on/off	125, 133
Paired device list	130, 140
Pairing a Bluetooth® device	126, 133
Profiles	128, 138
Status display.....	129, 139



C

Calendar 239
Call lists 89
Calling on a Bluetooth® phone 87
 Call lists..... 89
 Contacts list 88
 Dial..... 87
 Phone book..... 88
 POI call 90
 Short message..... 90
 SOS screen button..... 91
CD 36
 Control panel/screen..... 36
 Options..... 40
 Playing an audio CD 39
 Playing an MP3/WMA/AAC disc 39
CD player and discs 68
CD-R and CD-RW discs 72
Cellular phone 76
Connected service..... 244
Contacts 88
Contacts list..... 88
Coordinates 194
Current vehicle position 177

D

DAB 28
Deleting personal data..... 122
Destination search 188
 Address 190
 Coordinates..... 194
 Map 194
 Phone book 190
 POIs 191
 Previous destinations 189
 Registered points 189
Detouring a segment on the route 207
Dial..... 87
Dialing a second number 95
Display settings..... 123
 Camera display 124
 Day mode..... 124
Displaying route information 205
Displaying the turn list..... 206
Download application..... 259
 Downloading an application 259
 Operating an application 260



ALPHABETICAL INDEX

E

E-mail	237
Checking	238
Receiving	237
Editing route	202
Adding and editing stopovers.....	203
Blocking road ahead	206
Detouring a segment on the route	207
Displaying route information	205
Displaying the turn list.....	206
Recalculating by the traffic messages	209
Stopping route guidance.....	203
Entry information	216

F

File (audio).....	70
FM	28
Fuel consumption	114
Past record.....	115
Trip information.....	115

G

General settings.....	120
-----------------------	-----

H

Hands-free system.....	79
Connecting Bluetooth® phone.....	82
Phone book	81
Phone switch/microphone	80
Release your car	81
Heading-up	179

I

Icon information	180
Inserting or ejecting a disc.....	26
Internet connection	136
Quick setup of an internet connection	145
iPod.....	47, 67
Audio	51
Control panel/screen	47
Options.....	52



L

List screen 19
Loading POIs/route..... 258
 Cellular phone..... 258
 USB memory..... 258

M

Map..... 177
Map icons 180
 Icon information 180
 POI icons 181
Map screen..... 173, 177
 Configurations..... 178
 Current vehicle position 177
 Scrolling the map 178
Map settings 221
Memory point..... 210
MirrorLink™..... 241
MP3 36, 70, 72

N

Navigation..... 168
Navigation database updates 230
Navigation menu screen 173
Navigation system function index 175
North-up..... 179

O

Online search..... 251
 POI details..... 254
 Selecting a search engine..... 255
Overview buttons 14



ALPHABETICAL INDEX

P

Panoramio	257
Phone	76
Phone book	81, 88, 190
Phone switch/microphone	80
Picture	235
Picture slideshow.....	235
Displaying the pictures.....	235
POI call	90
POI category.....	191
POI icons	181
POIs.....	191
Previous destinations	189

R

Radio	28, 65
Control panel/screen	28
Options.....	34
Presetting a station	31
RDS (Radio Data System)	32
Tuning	31
RDS (Radio Data System).....	32
Rear view monitor system	154
Camera	159
Guide lines	156
Screen.....	156
Recalculating by the traffic messages	209
Receiving calls on a Bluetooth® phone.....	92
Registered points.....	189
Registering entry.....	83, 210
Displaying and editing	85
Registering.....	83, 210
Sending to USB memory.....	86
Road preference	224
Route guidance.....	196
Adjusting	197
Starting.....	196
Route guidance screen.....	199
Route settings.....	224



S

Scrolling the map..... 178
Search engine 255
Sending tones..... 94
Setup 118
Short message 90, 97
 Checking received short
 messages..... 97
 Receiving 97
 Sending..... 99
SMS..... 97
SOS screen button 91
Speech command system 110
Steering switches 63
Stopping route guidance..... 203
Stored contacts..... 219
 Restoring from a USB memory 220
 Sending to a USB memory 219
Stored route..... 210
Street View 256
System function index 12

T

TA (Traffic announcement)..... 33
Talking on a Bluetooth® phone..... 93
 Dialing a second number 95
 Receiver volume 96
 Sending tones 94
Telephone settings 148
Touch screen gestures 16
Touch screen operation 17
 Entering screen 18
 List screen..... 19
Toyota Eurocare 242
 Registering a country 242
 Using the Toyota Eurocare 243
Toyota web account settings 146
Traffic message settings 225
Traffic messages 185
Travel time 199
Tuning..... 31
Turn list..... 206



ALPHABETICAL INDEX

U

USB memory	41
Control panel/screen	41
Options	46
Playing a USB memory	45
USB/AUX port	27

V

Vehicle settings	151
Voice guidance	200
Volume settings	122

W

Wi-Fi®	142
Operating hints	145
WMA	36, 70, 72

Map database information

END-USER TERMS

The data ("Data") is provided for your personal, internal use only and not for resale. It is protected by copyright, and is subject to the following terms and conditions which are agreed to by you, on the one hand, and Harman ("Harman") and its licensors (including their licensors and suppliers) on the other hand.

© 2011 NAVTEQ B.V., © Bundesamt für Eich- und Vermessungswesen, © EuroGeographics, source: © IGN 2009 - BD TOPO[®], Die Grundlagendaten wurden mit

Genehmigung der zuständigen Behörden entnommen, Contains Ordnance Survey data © Crown copyright and database right 2010 Contains Royal Mail data © Royal Mail copyright and database right 2010, Copyright Geomatics Ltd., Copyright © 2003; Top-Map Ltd., La Banca Dati Italiana è stata prodotta usando quale riferimento anche cartografia numerica ed al tratto prodotta e fornita dalla Regione Toscana., Copyright © 2000; Norwegian Mapping Authority, Source: lgeoE – Portugal, Información geográfica propiedad del CNIG, Based upon electronic data Ó National Land Survey Sweden., Topografische Grundlage: Ó Bundesamt für Landestopographie.. All rights reserved.

TERMS AND CONDITIONS

PLEASE READ THIS END USER LICENSE AGREEMENT CAREFULLY BEFORE USING THE NAVTEQ DATABASE

NOTICE TO THE USER

THIS IS A LICENSE AGREEMENT - AND NOT AN AGREEMENT FOR SALE - BETWEEN YOU AND NAVTEQ B.V. FOR YOUR COPY OF THE NAVTEQ NAVIGABLE MAP DATA-BASE, INCLUDING ASSOCIATED COMPUTER SOFTWARE, MEDIA AND EXPLANATORY PRINTED DOCUMENTATION PUBLISHED BY NAVTEQ (JOINTLY "THE DATABASE"). BY USING THE DATABASE, YOU ACCEPT AND AGREE TO ALL TERMS AND CONDITIONS OF THIS END USER LICENSE AGREEMENT ("AGREEMENT"). IF YOU DO NOT AGREE TO THE TERMS OF THIS AGREEMENT, PROMPTLY RETURN THE DATABASE, ALONG WITH ALL OTHER ACCOMPANYING ITEMS, TO YOUR SUPPLIER FOR A REFUND.

OWNERSHIP

The Database and the copyrights and intellectual property or neighboring rights therein are owned by NAVTEQ or its licensors. Ownership of the media on which the Database is contained is retained by NAVTEQ and/or your supplier until after you have paid in full any amounts due to NAVTEQ and/or your supplier pursuant to this Agreement or similar agreement(s) under which goods are provided to you.

LICENSE GRANT

NAVTEQ grants you a non-exclusive license to use the Database for your personal use or, if applicable, for use in your business' internal operations. This license does not include the right to grant sub-licenses.

LIMITATIONS ON USE

The Database is restricted for use in the specific system for which it was created. Except to the extent explicitly permitted by mandatory laws (e.g. national laws based on the European Software Directive (91/250) and the Database Directive (96/9)), you may not extract or reutilize substantial parts of the contents of the Database nor reproduce, copy, modify, adapt, translate, disassemble, decompile, reverse engineer any portion of the Database. If you wish to obtain interoperability information as meant in (the national laws based on) the European Software Directive, you shall grant NAVTEQ reasonable opportunity to provide said information on reasonable terms, including costs, to be determined by NAVTEQ.

TRANSFER OF LICENSE

You may not transfer the Database to third parties, except when installed in the system for which it was created or when you do not retain any copy of the Database, and provided that the transferee agrees to all terms and conditions of this Agreement and confirms this in writing to NAVTEQ. Multi-disc sets may only be transferred or sold as a complete set as provided by NAVTEQ and not as subset thereof.

LIMITED WARRANTY

NAVTEQ warrants that, subject to the warnings set out below, for a period of 12 months after acquisition of your copy of the Database, it will perform substantially in accordance with NAVTEQ's Criteria for Accuracy and Completeness existing on the date you acquired the Database; these criteria are available from NAVTEQ at your request. If the Database does not perform in accordance with this limited warranty, NAVTEQ will use reasonable efforts to repair or replace your non-conforming copy of the Database. If these efforts do not lead to performance of the Database in accordance with the warranties set out herein, you will have the option to either receive a reasonable refund of the price you paid for the Database or to rescind this Agreement. This shall be NAVTEQ's entire liability and your sole remedy against NAVTEQ. Except as expressly provided in this section, NAVTEQ does not warrant nor make any representations regarding the use of results of the use of the Database in terms of its correctness, accuracy, reliability, or otherwise. NAVTEQ does not warrant that the Database is or will be error free. No oral or written information or advice provided by NAVTEQ, your supplier or any other person shall create a warranty or in any way increase the scope of the limited warranty described above. The limited warranty set forth in this Agreement does not affect or prejudice any statutory legal rights that you may have under the legal warranty against hidden defects.

If you did not acquire the Database from NAVTEQ directly, you may have statutory rights against the person from whom you have acquired the Database in addition to the rights granted by NAVTEQ hereunder according to the law of your jurisdiction. The above warranty of NAVTEQ shall not affect such statutory rights and you may assert such rights in addition to the warranty rights granted herein.

LIMITATION OF LIABILITY

The price of the Database does not include any consideration for assumption of risk of consequential, indirect or unlimited direct damages which may arise in connection with your use of the Database. Accordingly, in no event shall NAVTEQ be liable for any consequential or indirect damages, including without limitation, loss of revenue, data, or use, incurred by you or any third party arising out of your use of the Database, whether in an action in contract or tort or based on a warranty, even if NAVTEQ has been advised of the possibility of such damages. In any event NAVTEQ's liability for direct damages is limited to the price of your copy of the Database.

THE LIMITED WARRANTY AND LIMITATION OF LIABILITY, SET FORTH IN THIS AGREEMENT, DO NOT AFFECT OR PREJUDICE YOUR STATUTORY RIGHTS WHERE YOU HAVE ACQUIRED THE DATABASE OTHERWISE THAN IN THE COURSE OF A BUSINESS.

WARNINGS

The Database may contain inaccurate or incomplete information due to the passage of time, changing circumstances, sources used and the nature of collecting comprehensive geographic data, any of which may lead to incorrect results. The Database does not include or reflect information on - inter alia - neighborhood safety; law enforcement; emergency assistance; construction work; road or lane closures; vehicle or speed restrictions; road slope or grade; bridge height, weight or other limits; road or traffic conditions; special events; traffic congestion; or travel time.

GOVERNING LAW

This Agreement shall be governed by the laws of the jurisdiction, in which you reside at the date of acquisition of the Database. Should you at that moment reside outside the European Union or Switzerland, the law of the jurisdiction within the European Union or Switzerland where you acquired the Database shall apply. In all other cases, or if the jurisdiction where you acquired the Database cannot be defined, the laws of the Netherlands shall apply. The courts competent at your place of residence at the time you acquired the Database shall have jurisdiction over any dispute arising out of, or relating to this Agreement, without prejudice to NAVTEQ' right to bring claims at your then current place of residence.

Certification



Declaration of Conformity (DoC)

Hereby, Panasonic Corporation, declares that this Bluetooth Module ASSY (YEAP01B918/YEAP01A727) is in compliance with the essential requirements and other relevant provisions of Directive 1999/5/EC.

The latest original "DECLARATION of CONFORMITY" (DoC) is available at the address stated.

[DoC Website address]

<http://www.ptc.panasonic.de/>

(To see the Doc for the product's component, input the product search number: YEAP01B918/YEAP01A727)

С настоящето, Panasonic Corporation, декларира, че YEAP01B918/YEAP01A727 е в съответствие със съществените изисквания и другите приложими разпоредби на Директива 1999/5/EC.
Panasonic Corporation tímto prohlašuje, že tento YEAP01B918/YEAP01A727 je ve shodě se základními požadavky a dalšími příslušnými ustanoveními směrnice 1999/5/ES.
Undertegnede Panasonic Corporation erklærer herved, at følgende udstyr YEAP01B918/YEAP01A727 overholder de væsentlige krav og øvrige relevante krav i direktiv 1999/5/EF.
Hierbij verklaart Panasonic Corporation dat het toestel YEAP01B918/YEAP01A727 in overeenstemming is met de essentiële eisen en de andere relevante bepalingen van richtlijn 1999/5/EG.
Hereby, Panasonic Corporation, declares that this YEAP01B918/YEAP01A727 is in compliance with the essential requirements and other relevant provisions of Directive 1999/5/EC.
Käesolevaga kinnitab Panasonic Corporation seadme YEAP01B918/YEAP01A727 vastavust direktiivi 1999/5/EÜ põhinõuetele ja nimetatud direktiivist tulenevatele teistele asjakohastele sätetele.
Panasonic Corporation vakuuttaa täten että YEAP01B918/YEAP01A727 tyyppinen laite on direktiivin 1999/5/EY oleellisten vaatimusten ja sitä koskevien direktiivin muiden ehtojen mukainen.
Par la présente Panasonic Corporation déclare que l'appareil YEAP01B918/YEAP01A727 est conforme aux exigences essentielles et aux autres dispositions pertinentes de la directive 1999/5/CE.
Hiermit erklärt Panasonic Corporation, dass sich das Gerät YEAP01B918/YEAP01A727 in Übereinstimmung mit den grundlegenden Anforderungen und den übrigen einschlägigen Bestimmungen der Richtlinie 1999/5/EG befindet.
ΜΕ ΤΗΝ ΠΑΡΟΥΣΑ Panasonic Corporation ΔΗΛΩΝΕΙ ΟΤΙ YEAP01B918/YEAP01A727 ΣΥΜΜΟΡΦΩΝΕΤΑΙ ΠΡΟΣ ΤΙΣ ΟΥΣΙΩΔΕΙΣ ΑΠΑΙΤΗΣΕΙΣ ΚΑΙ ΤΙΣ ΛΟΙΠΕΣ ΣΧΕΤΙΚΕΣ ΔΙΑΤΑΞΕΙΣ ΤΗΣ ΟΔΗΓΙΑΣ 1999/5/ΕΚ.
Alulírott, Panasonic Corporation nyilatkozom, hogy a YEAP01B918/YEAP01A727 megfelel a vonatkozó alapvető követelményeknek és az 1999/5/EC irányelv egyéb előírásainak.
Con la presente Panasonic Corporation dichiara che questo YEAP01B918/YEAP01A727 è conforme ai requisiti essenziali ed alle altre disposizioni pertinenti stabilite dalla direttiva 1999/5/CE.

Ar šo Panasonic Corporation deklarē, ka YEAP01B918/YEAP01A727 atbilst Direktīvas 1999/5/EK būtiskajām prasībām un citiem ar to saistītajiem noteikumiem.
Šiuo Panasonic Corporation deklaruoja, kad šis YEAP01B918/YEAP01A727 atitinka esminius reikalavimus ir kitas 1999/5/EB Direktyvos nuostatas.
Hawnhekk, Panasonic Corporation, jiddikjara li dan YEAP01B918/YEAP01A727 jikkonforma mal-htigijiet essenzzjali u ma provvedimenti oħrajn relevanti li hemm fid-Direttiva 1999/5/EC.
Niniejszym Panasonic Corporation oświadcza, że YEAP01B918/YEAP01A727 jest zgodny z zasadniczymi wymogami oraz pozostałymi stosownymi postanowieniami Dyrektywy 1999/5/EC.
Panasonic Corporation declara que este YEAP01B918/YEAP01A727 está conforme com os requisitos essenciais e outras disposições da Directiva 1999/5/CE.
Prin prezenta, Panasonic Corporation, declară că aparatul YEAP01B918/YEAP01A727 este în conformitate cu cerințele esențiale și cu alte prevederi pertinente ale Directivei 1999/5/CE.
Panasonic Corporation týmto vyhlasuje, že YEAP01B918/YEAP01A727 splňa základné požiadavky a všetky príslušné ustanovenia Smernice 1999/5/ES.
Panasonic Corporation izjavlja, da je ta YEAP01B918/YEAP01A727 v skladu z bistvenimi zahtevami in ostalimi relevantnimi določili direktive 1999/5/ES.
Por medio de la presente Panasonic Corporation declara que el YEAP01B918/YEAP01A727 cumple con los requisitos esenciales y cualesquiera otras disposiciones aplicables o exigibles de la Directiva 1999/5/CE.
Härmed intygar Panasonic Corporation att denna YEAP01B918/YEAP01A727 står i överensstämmelse med de väsentliga egenskapskrav och övriga relevanta bestämmelser som framgår av direktiv 1999/5/EG.
Hér með lýsir Panasonic Corporation yfir því að YEAP01B918/YEAP01A727 er í samræmi við grunnkröfur og aðrar kröfur, sem gerðar eru í tilskipun 1999/5/EC.
Panasonic Corporation erklærer herved at utstyret YEAP01B918/YEAP01A727 er i samsvar med de grunnleggende krav og øvrige relevante krav i direktiv 1999/5/EF.
Ovim , Panasonic Corporation, izjavlja da ovaj YEAP01B918/YEAP01A727 je usklađen sa bitnim zahtjevima i drugim relevantnim odredbama Direktive 1999/5/EC.
Nepermjet kesaj, Panasonic Corporation, deklaroi qe ky YEAP01B918/YEAP01A727 eshte ne pajtim me kerkesat thelbesore dhe dispozitat e tjera perkatese te Direktives 1999/5/EC.
Ovim Panasonic Corporation, izjavlja da je YEAP01B918/YEAP01A727 u skladu s bitnim zahtjevima drugim relevantnim odredbama Direktive 1999/5/EC.
Овим, Panasonic Corporation, изјављује да је овај YEAP01B918/YEAP01A727 је у складу са основним захтевима и другим битним одредбама Директиве 1999/5/ЕЦ.





