

TABLE OF CONTENTS

1	Before driving	Adjusting and operating features such as door locks, mirrors, and steering column
2	When driving	Driving, stopping and safe-driving information
3	Interior features	Air conditioning and audio systems, as well as other interior features for a comfortable driving experience
4	Maintenance and care	Cleaning and protecting your vehicle, performing do-it-yourself maintenance, and maintenance information
5	When trouble arises	What to do if the vehicle needs to be towed, gets a flat tire, or is involved in an accident
6	Vehicle specifications	Detailed vehicle information
	Index	Alphabetical listing of information contained in this manual

1 Before driving

1-1. Key information
 Keys 38

1-2. Opening, closing and locking the doors
 Smart entry & start system ... 42
 Wireless remote control 64
 Side doors..... 73
 Back door..... 79

1-3. Adjustable components (seats, mirrors, steering wheel)
 Front seats 84
 Rear seats 86
 Head restraints 94
 Seat belts 96
 Steering wheel 104
 Anti-glare inside rear view mirror 105
 Outside rear view mirrors.... 109

1-4. Opening and closing the windows and panoramic roof shade
 Power windows 112
 Panoramic roof shade..... 116

1-5. Refueling
 Opening the fuel tank cap... 119

1-6. Theft deterrent system

Engine immobilizer system..... 124
 Double locking system 134
 Alarm..... 136

1-7. Safety information

Correct driving posture..... 145
 SRS airbags 147
 Child restraint systems 158
 Installing child restraints..... 166
 Airbag manual on-off system..... 178

2 When driving

2-1. Driving procedures

Driving the vehicle 184
 Engine (ignition) switch (vehicles without smart entry & start system) 198
 Engine (ignition) switch (vehicles with smart entry & start system) 202
 Multidrive 208
 Manual transmission 214
 Turn signal lever..... 218
 Parking brake 219
 Horn 221

2-2. Instrument cluster	
Gauges and meters	222
Indicators and warning lights	227
Multi-information display	232
2-3. Operating the lights and wipers	
Headlight switch	244
Fog light switch	251
Windshield wipers and washer	252
Rear window wiper and washer	257
2-4. Using other driving systems	
Cruise control	258
Speed limiter	262
Toyota parking assist-sensor	265
Stop & Start system	273
Driving assist systems	280
2-5. Driving information	
Cargo and luggage	286
Winter driving tips	289
Trailer towing	293

3 Interior features

3-1. Using the air conditioning system and defogger		1
Manual air conditioning system	304	
Automatic air conditioning system	310	2
Power heater	317	
Rear window and outside rear view mirror defoggers	319	3
3-2. Using the audio system		
Audio system types	321	
Using the radio	323	
Using the CD player	327	4
Playing back MP3 and WMA discs	332	
Operating an iPod	338	
Operating a USB memory	345	5
Optimal use of the audio system	352	
Using the AUX port	354	
Using the steering wheel audio switches	355	6
3-3. Using the interior lights		
Interior lights list	358	
• Personal/interior lights main switch	359	
• Personal/interior lights	360	

3-4. Using the storage features

List of storage features 362

- Glove box 363
- Console box..... 364
- Overhead console 366
- Cup holders 366
- Bottle holders..... 368
- Auxiliary boxes 369

3-5. Other interior features

Sun visors 371

Vanity mirrors..... 372

Conversation mirror 373

Power outlets 374

Seat heaters 376

Armrests 378

Front seatback tables 379

Rear side sunshades 381

Assist grips 382

Floor mat..... 383

Luggage compartment features..... 385

4 Maintenance and care

4-1. Maintenance and care

Cleaning and protecting the vehicle exterior 396

Cleaning and protecting the vehicle interior 400

4-2. Maintenance

Maintenance requirements..... 403

4-3. Do-it-yourself maintenance

Do-it-yourself service precautions 406

Hood..... 410

Positioning a floor jack 412

Engine compartment..... 414

Tires 431

Tire inflation pressure..... 445

Wheels 447

Air conditioning filter..... 450

Key battery 453

Checking and replacing fuses 457

Light bulbs..... 472

5 When trouble arises

5-1. Essential information

Emergency flashers 490

If your vehicle needs to be towed 491

If you think something is wrong 498

Fuel pump shut off system (gasoline engine) 499

5-2. Steps to take in an emergency

If a warning light turns on or a warning buzzer sounds... 500

If a warning message is displayed 509

If you have a flat tire (vehicles with spare tire)... 522

If you have a flat tire (vehicles with emergency tire puncture repair kit)..... 539

If the engine will not start 556

If the shift lever cannot be shifted from “P” (vehicles with a Multidrive)..... 559

If you lose your keys 560

If you cannot operate the back door opener..... 561

If the electronic key does not operate properly (vehicles with smart entry & start system)..... 562

If the vehicle battery is discharged 565

If your vehicle overheats..... 569

If the vehicle becomes stuck 572

If your vehicle has to be stopped in an emergency 574

6 Vehicle specifications

6-1. Specifications

Maintenance data (fuel, oil level, etc.)..... 578

Fuel information 599

6-2. Customization

Customizable features 602

6-3. Initialization

Items to initialize..... 606

Index

Abbreviation list..... 608

Alphabetical index 609

What to do if... 620



Pictorial index

Exterior

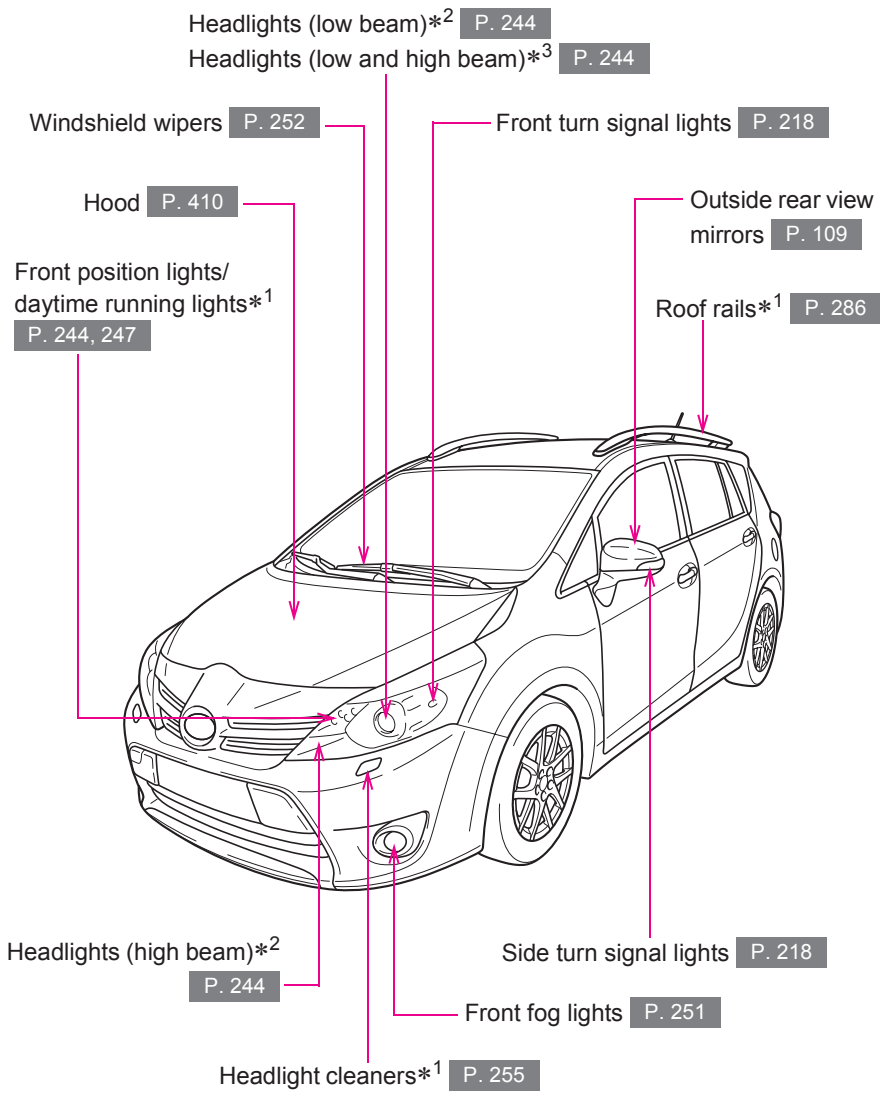

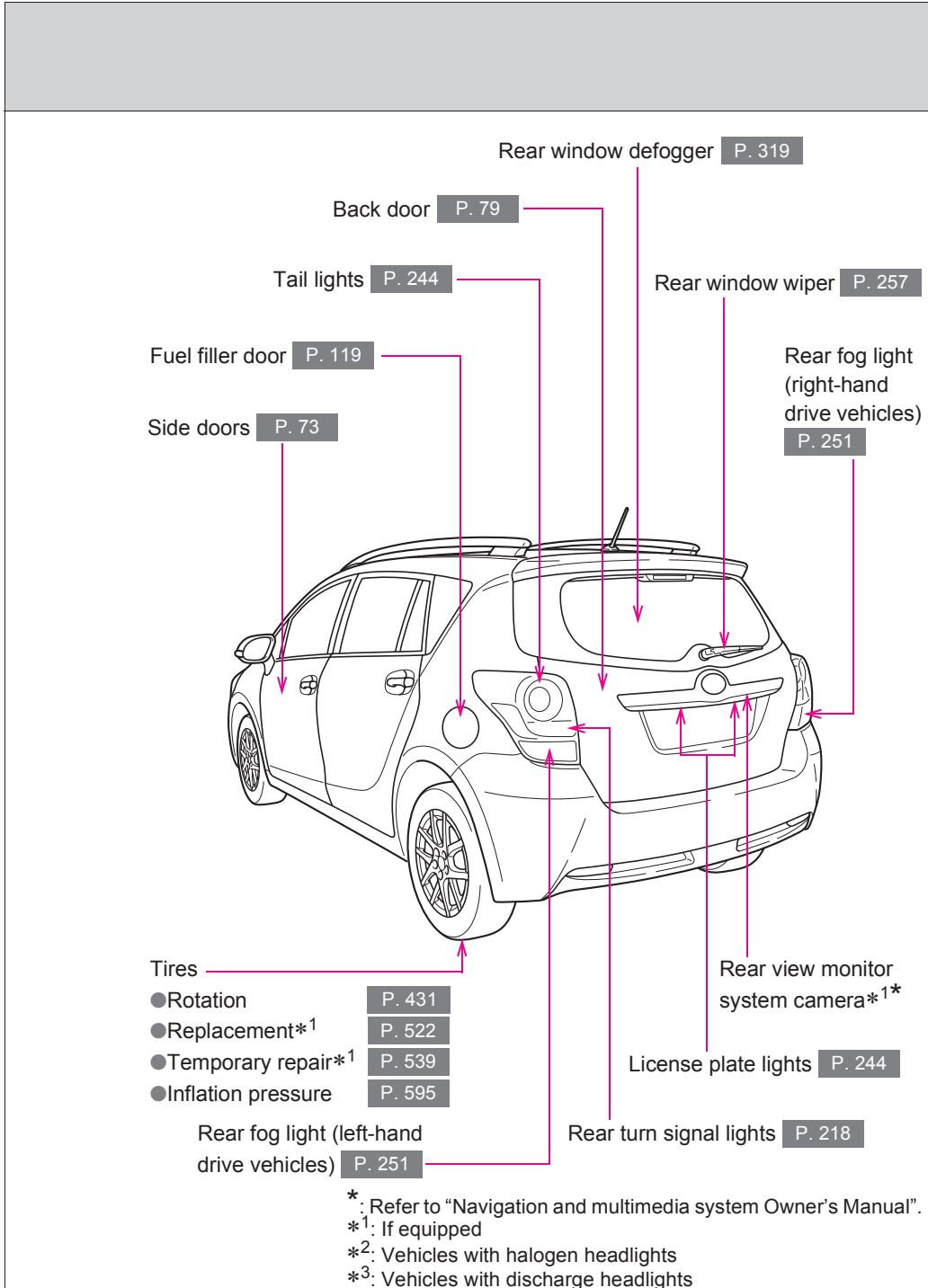

Pictorial index

Interior (left-hand drive vehicles)

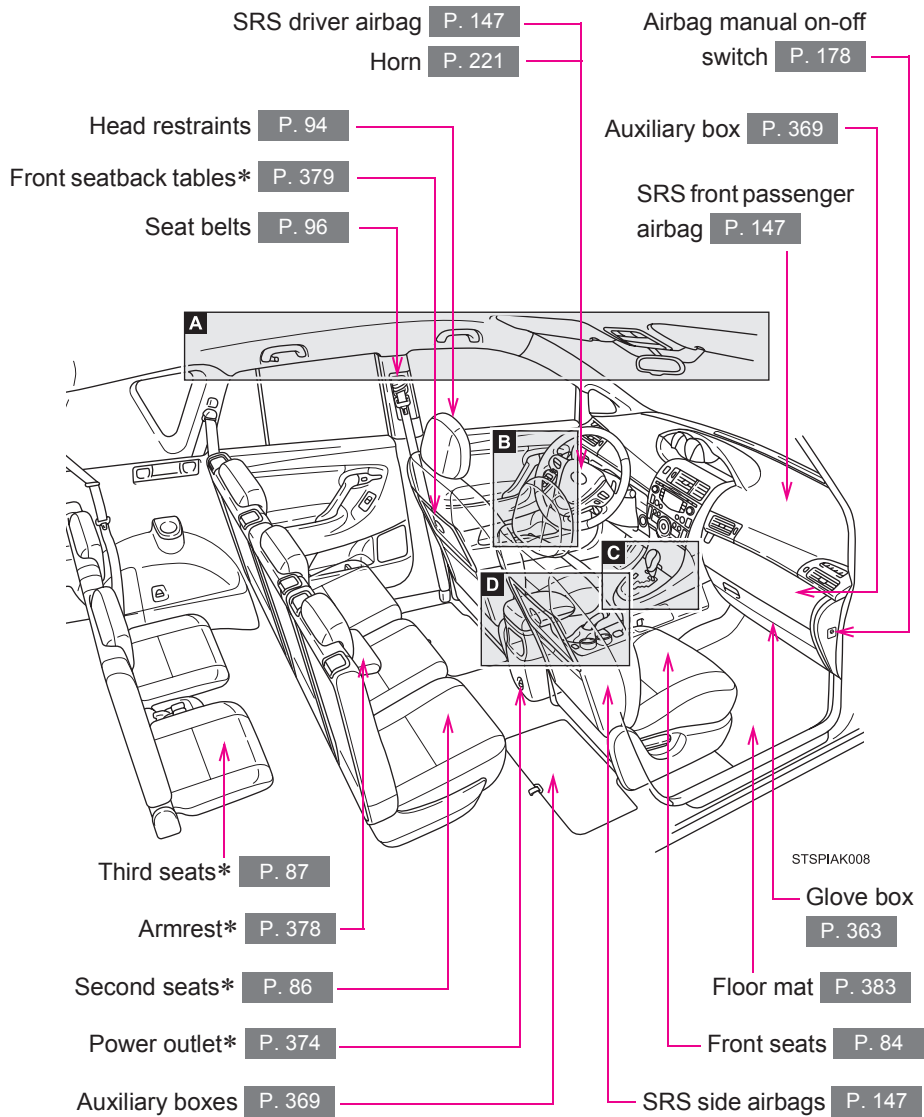

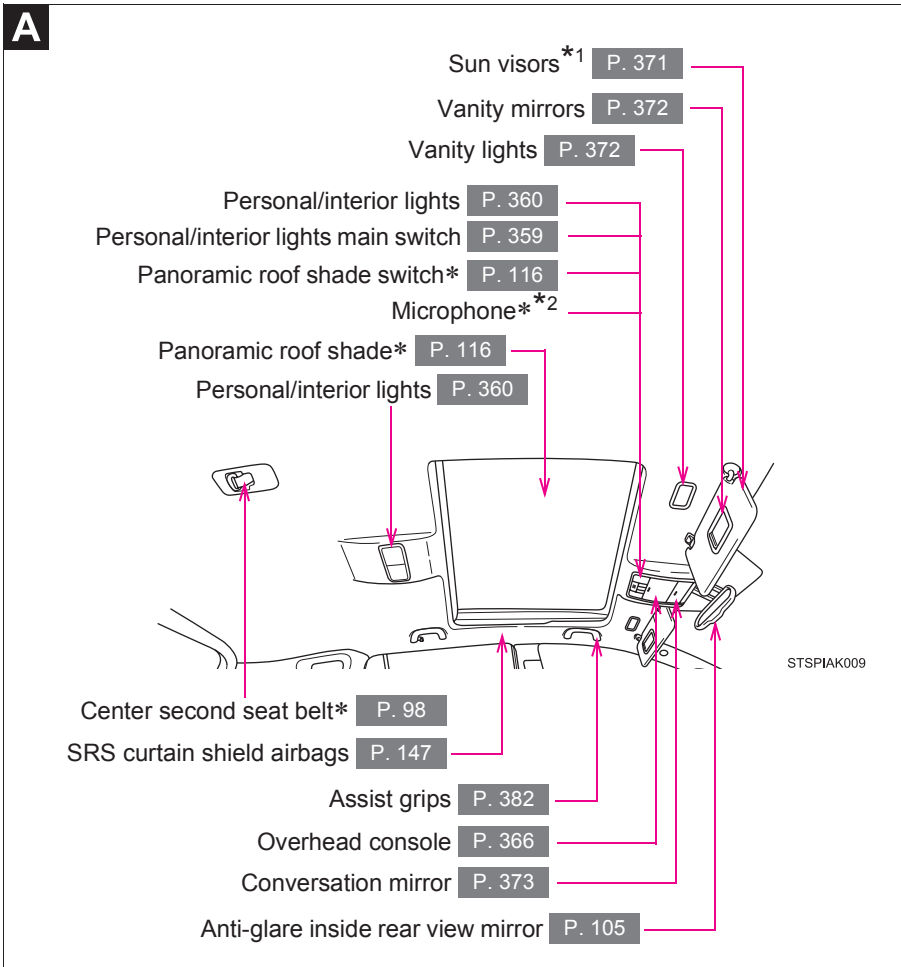

*: If equipped

*1: NEVER use a rearward facing child restraint on a seat protected by an ACTIVE AIRBAG in front of it, DEATH or SERIOUS INJURY to the CHILD can occur. (→P. 175)

*2: Refer to "Navigation and multimedia system Owner's Manual".



B

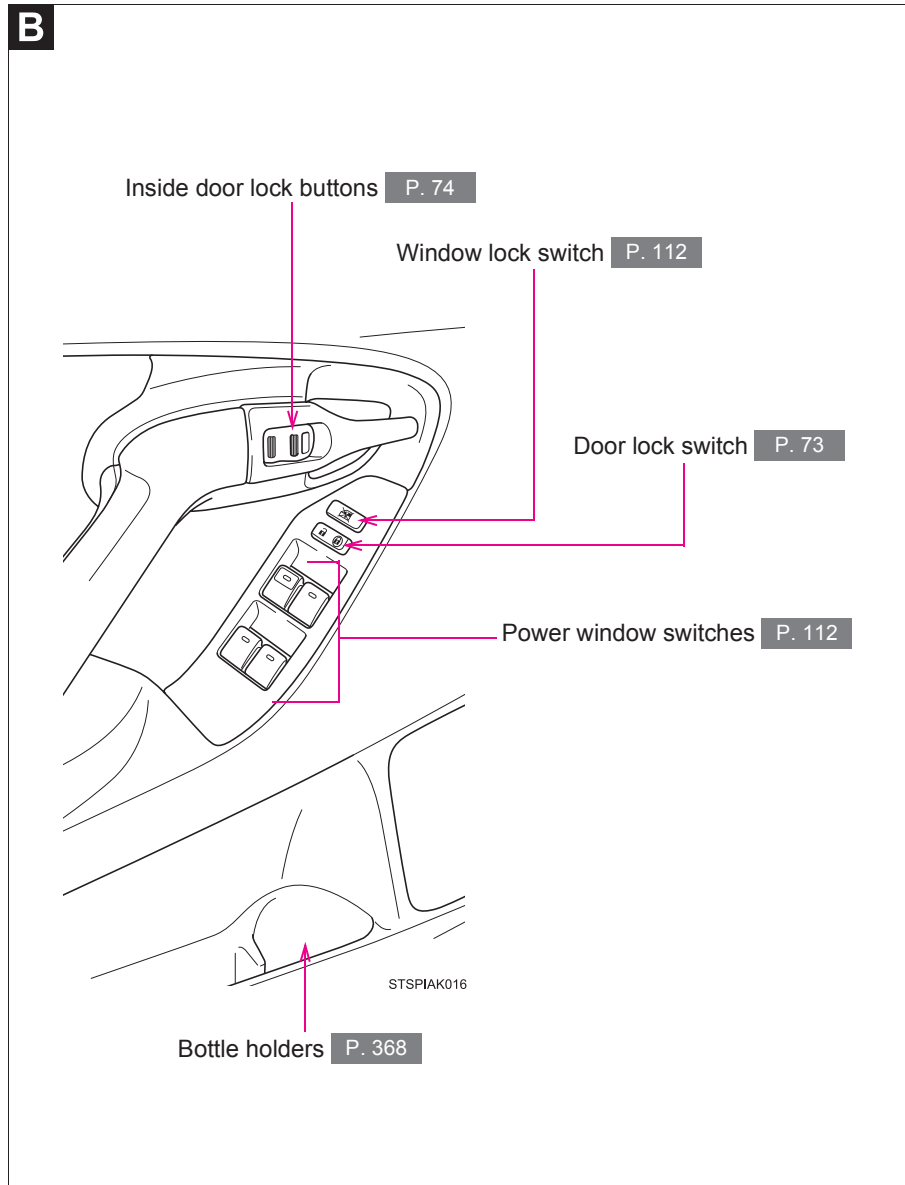

C

Shift lock override button* P. 559

Shift lever P. 208, 214

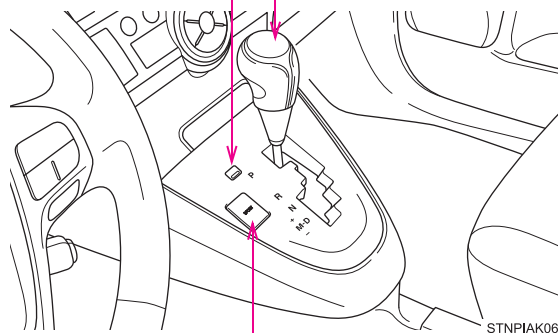

"SPORT" mode switch* P. 209

*: If equipped

D

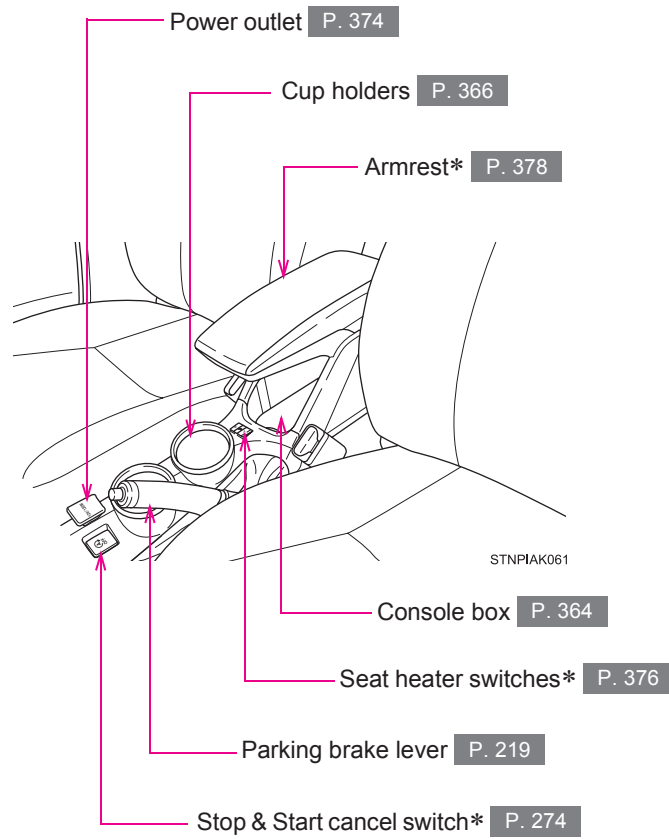

*: If equipped

Pictorial index

Instrument panel (left-hand drive vehicles)

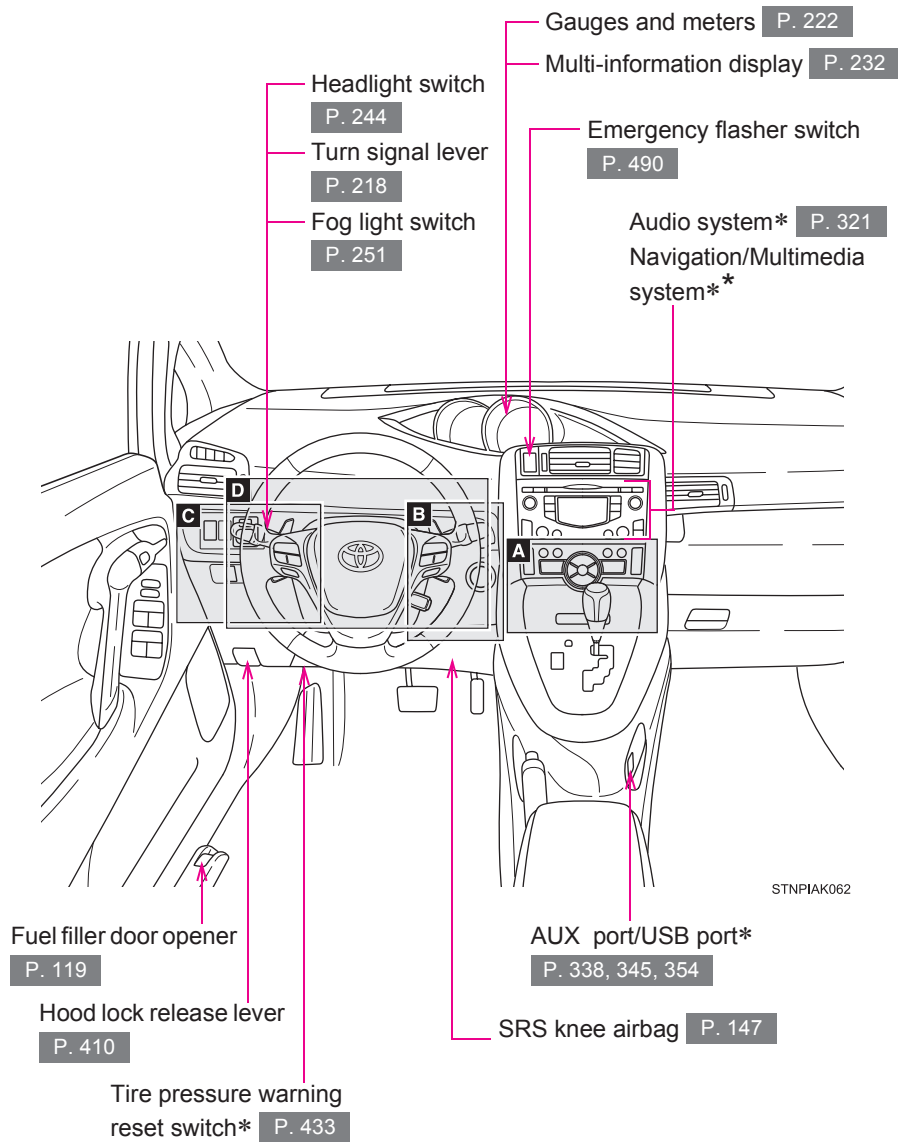

*: Refer to "Navigation and multimedia system Owner's Manual".

*: If equipped

A

► **Manual air conditioning system**

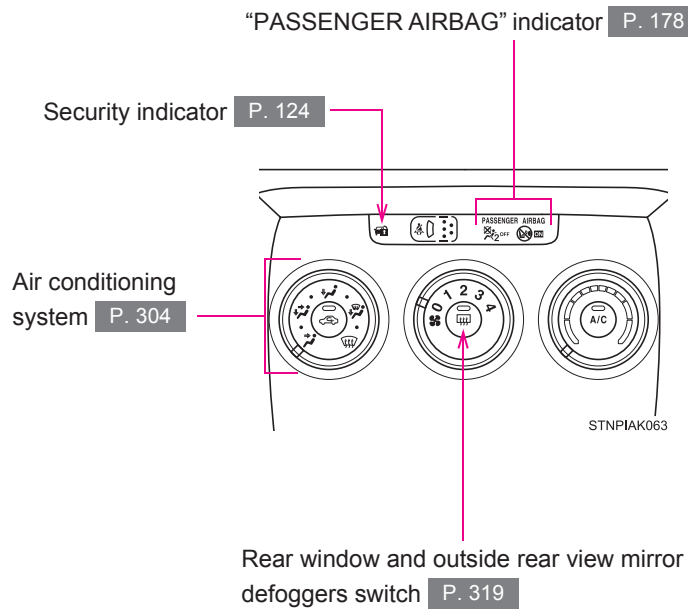

A

► **Automatic air conditioning system**

Rear window and outside rear view mirror defoggers switch **P. 319**

Air conditioning system **P. 310**

Security indicator **P. 124**

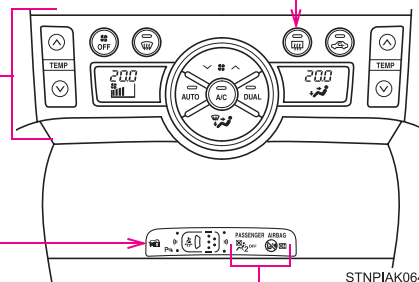

"PASSENGER AIRBAG" indicator **P. 178**

B

Engine (ignition) switch
(vehicles with smart entry & start system) P. 202

Windshield wipers and washer switch P. 252

Rear window wiper and washer switch P. 257

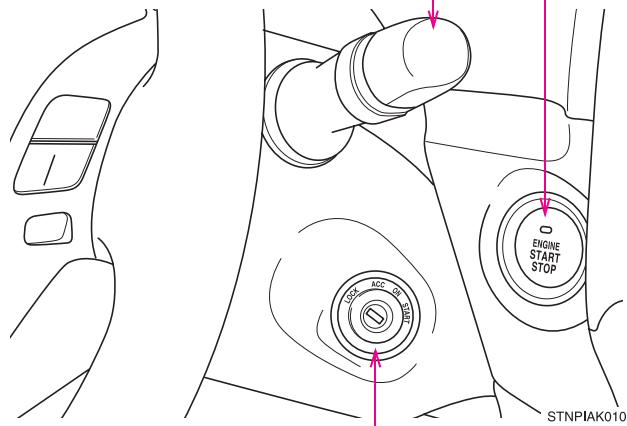

Engine (ignition) switch
(vehicles without smart entry & start system) P. 198

C

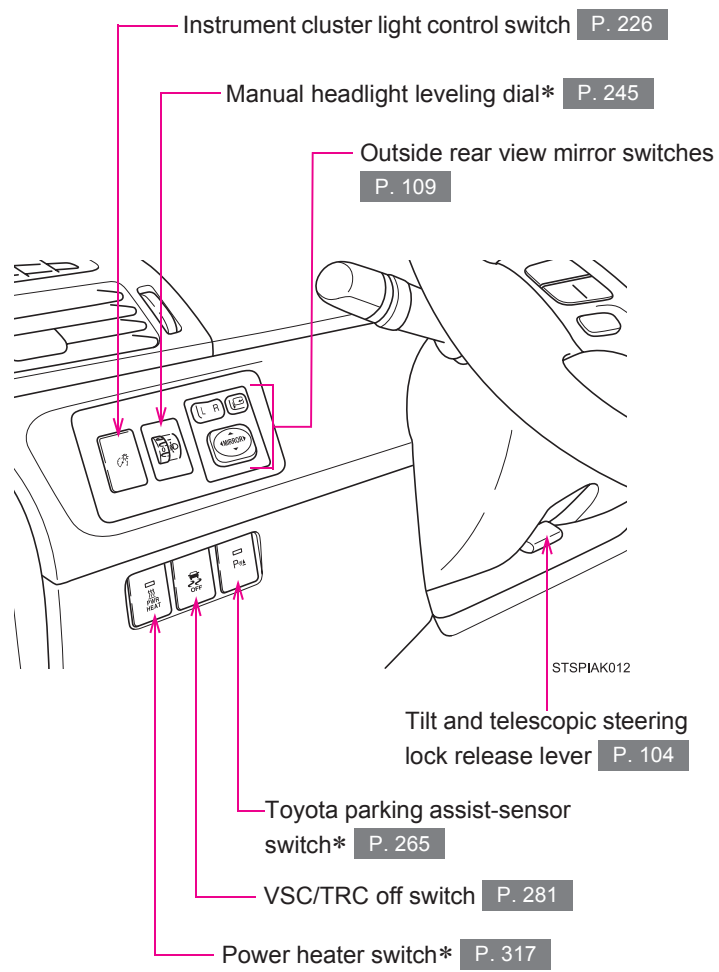

*: If equipped

Pictorial index

Instrument panel (left-hand drive vehicles)

D

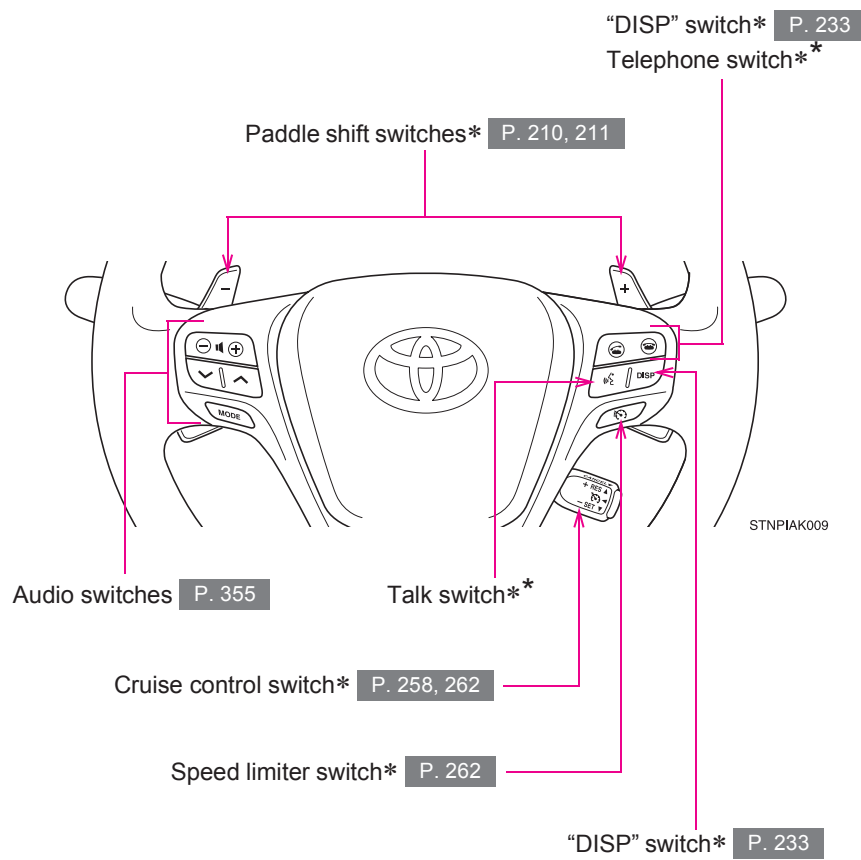

*: Refer to “Navigation and multimedia system Owner’s Manual”.
*: If equipped

Pictorial index

Interior (right-hand drive vehicles)

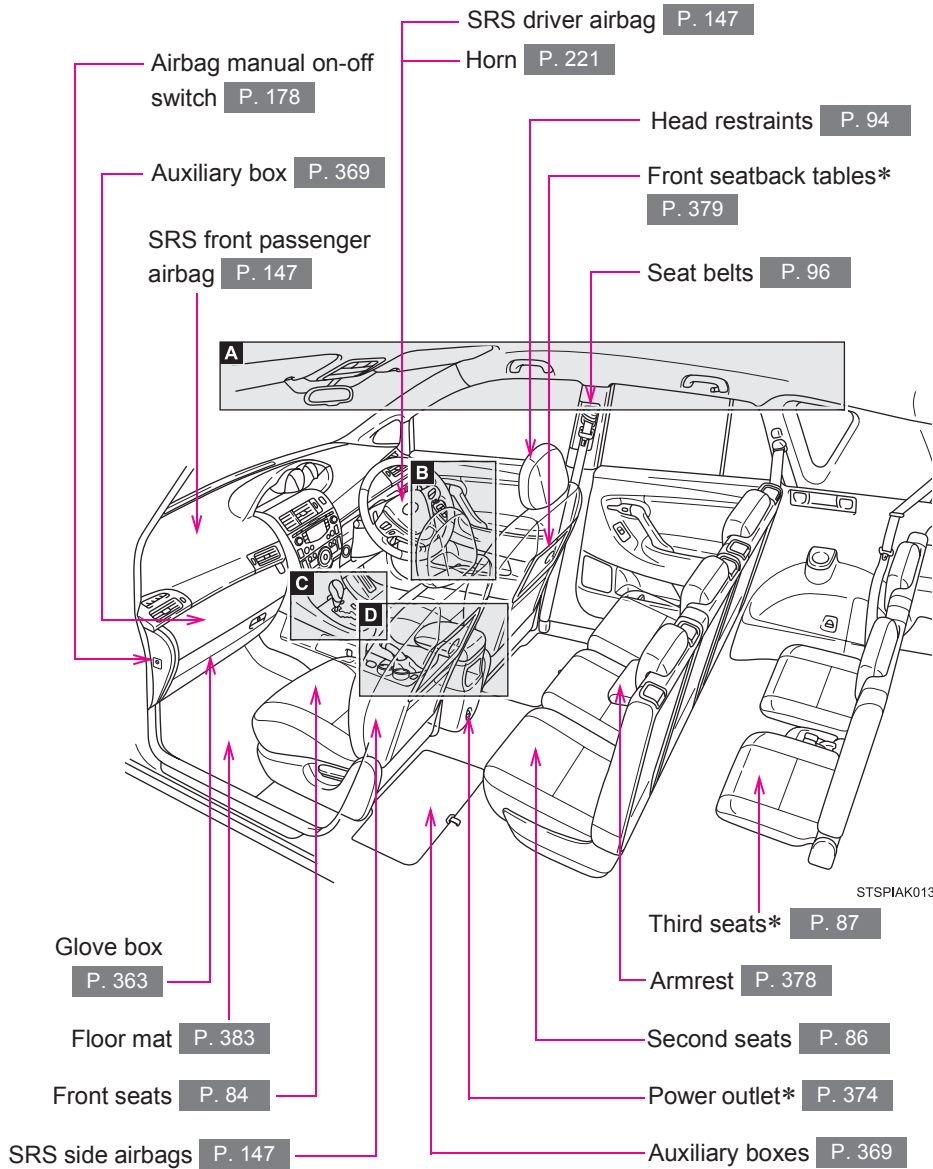

*: If equipped

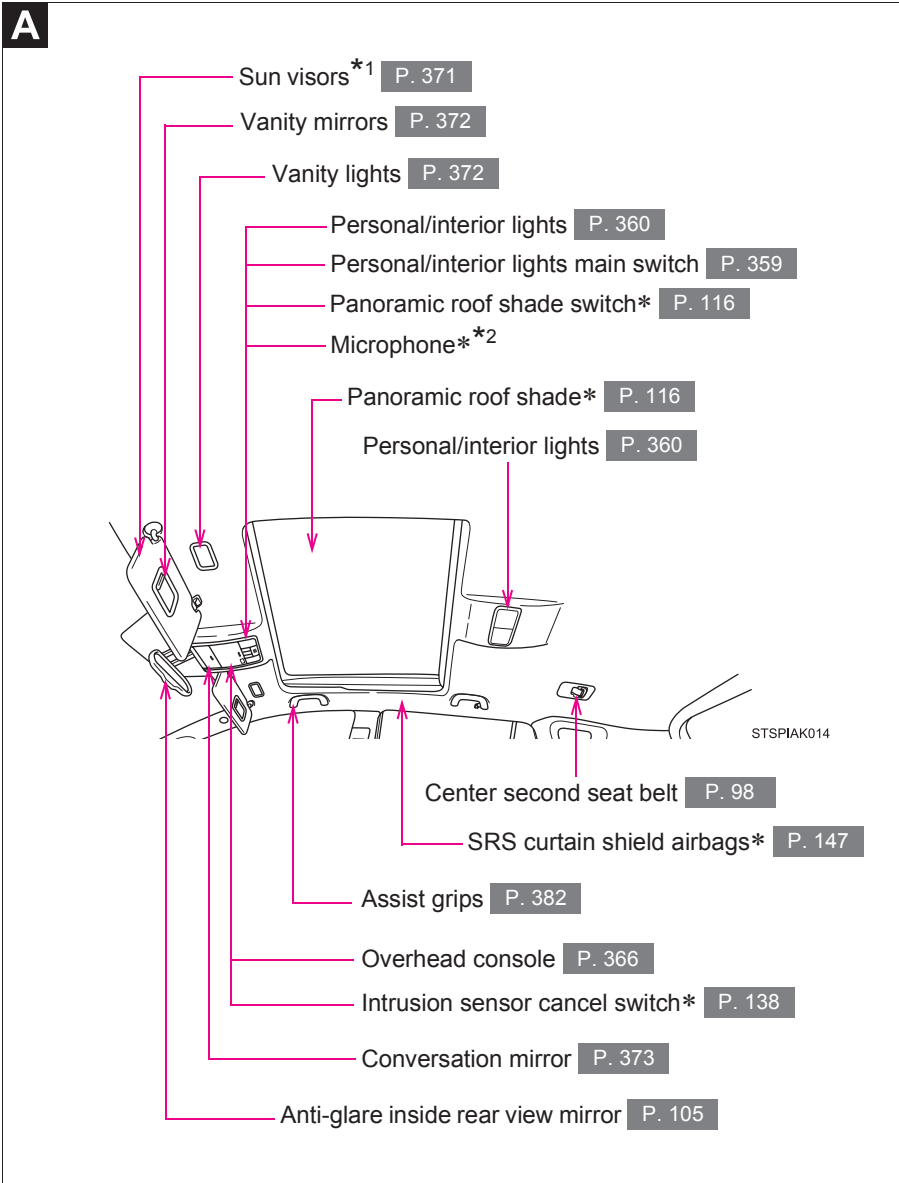

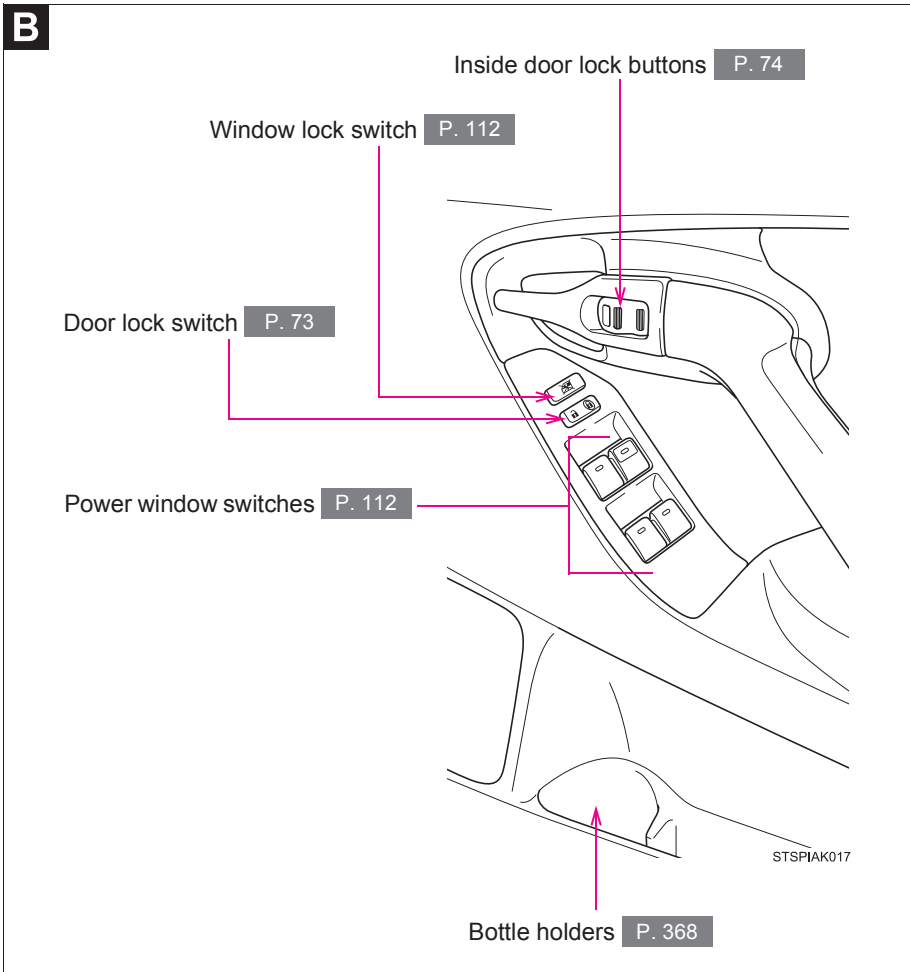

*: If equipped

*1: NEVER use a rearward facing child restraint on a seat protected by an ACTIVE AIRBAG in front of it, DEATH or SERIOUS INJURY to the CHILD can occur. (→P. 175)

*2: Refer to "Navigation and multimedia system Owner's Manual".



C

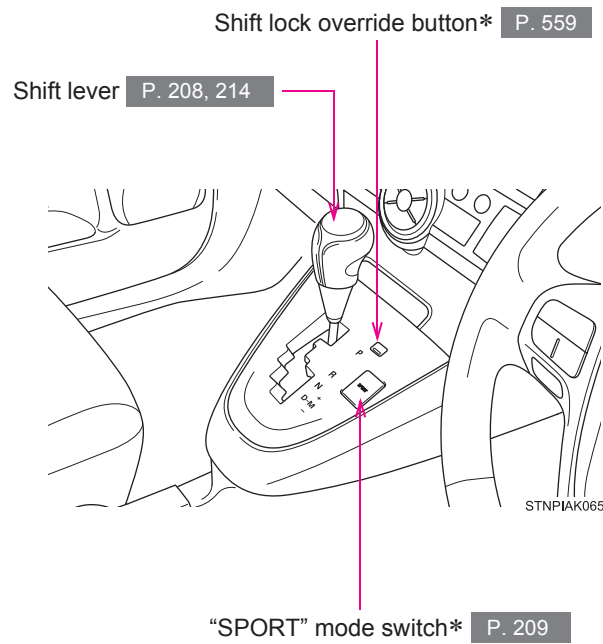

D

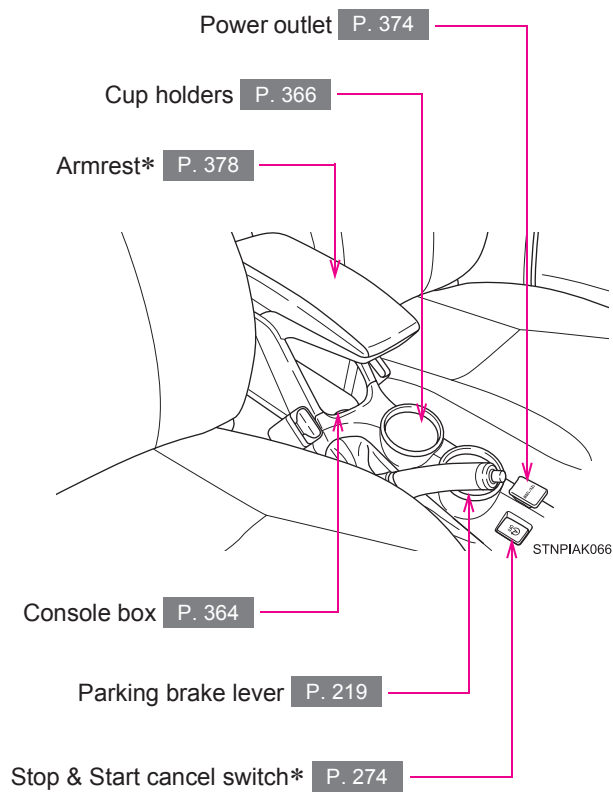

*: If equipped

Pictorial index

Instrument panel (right-hand drive vehicles)

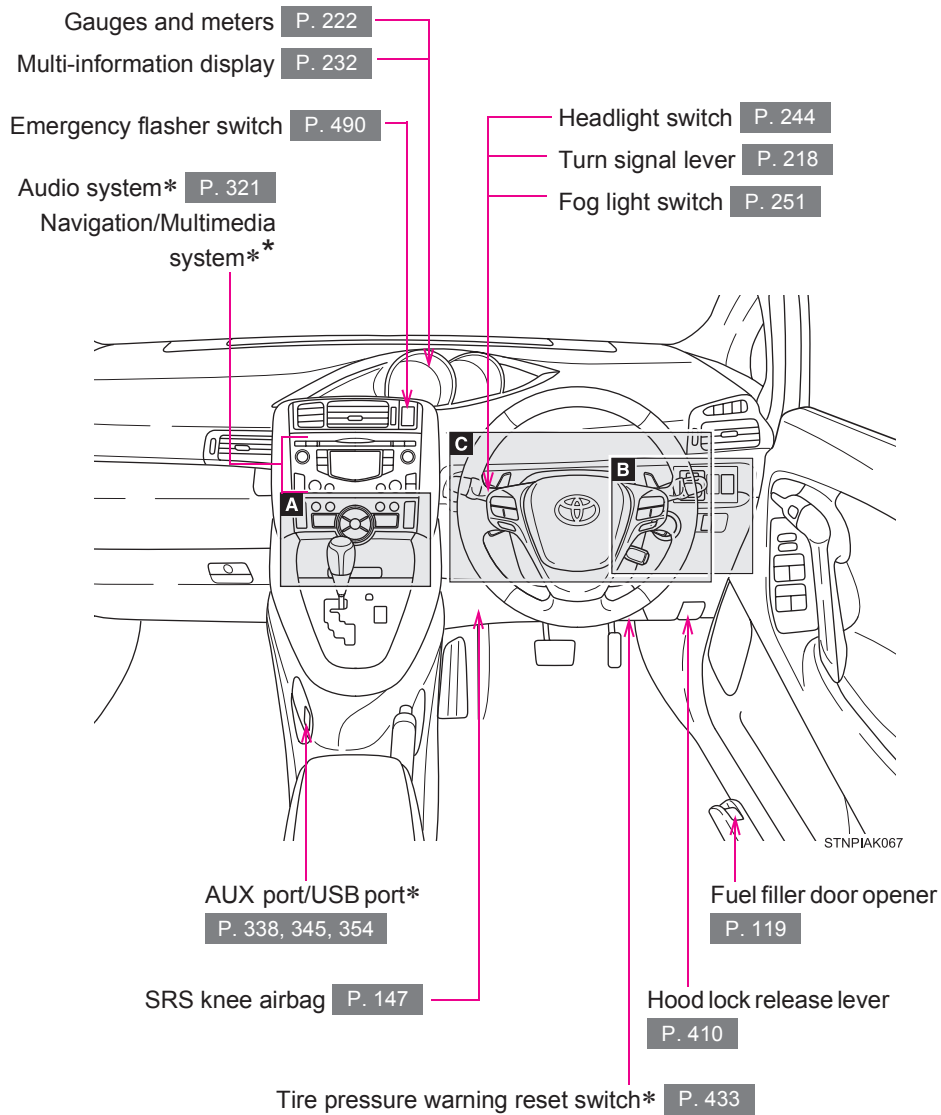

A

► **Manual air conditioning system**

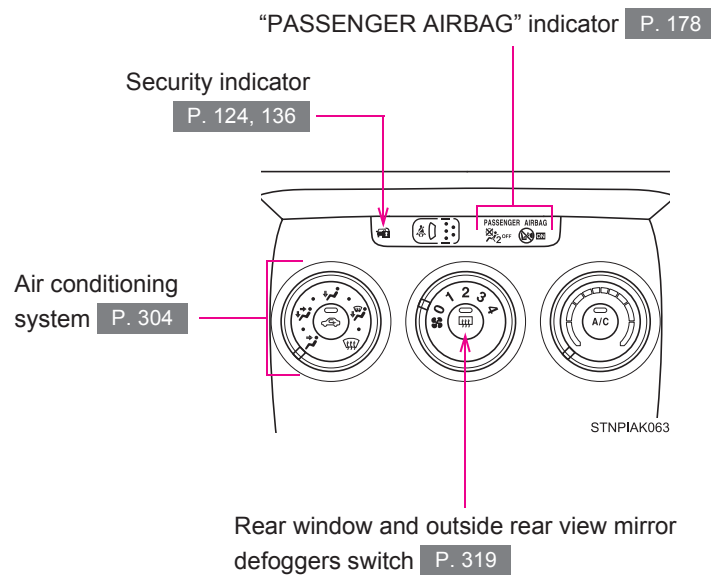

*: Refer to "Navigation and multimedia system Owner's Manual".
*: If equipped

A

► **Automatic air conditioning system**

Rear window and outside rear view mirror defoggers switch **P. 319**

Air conditioning system **P. 310**

Security indicator **P. 124, 136**

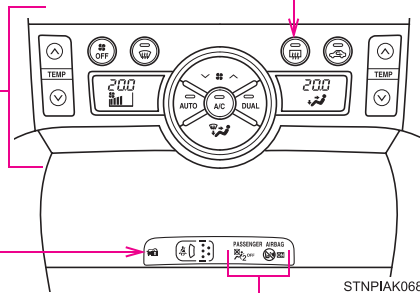

"PASSENGER AIRBAG" indicator **P. 178**

B

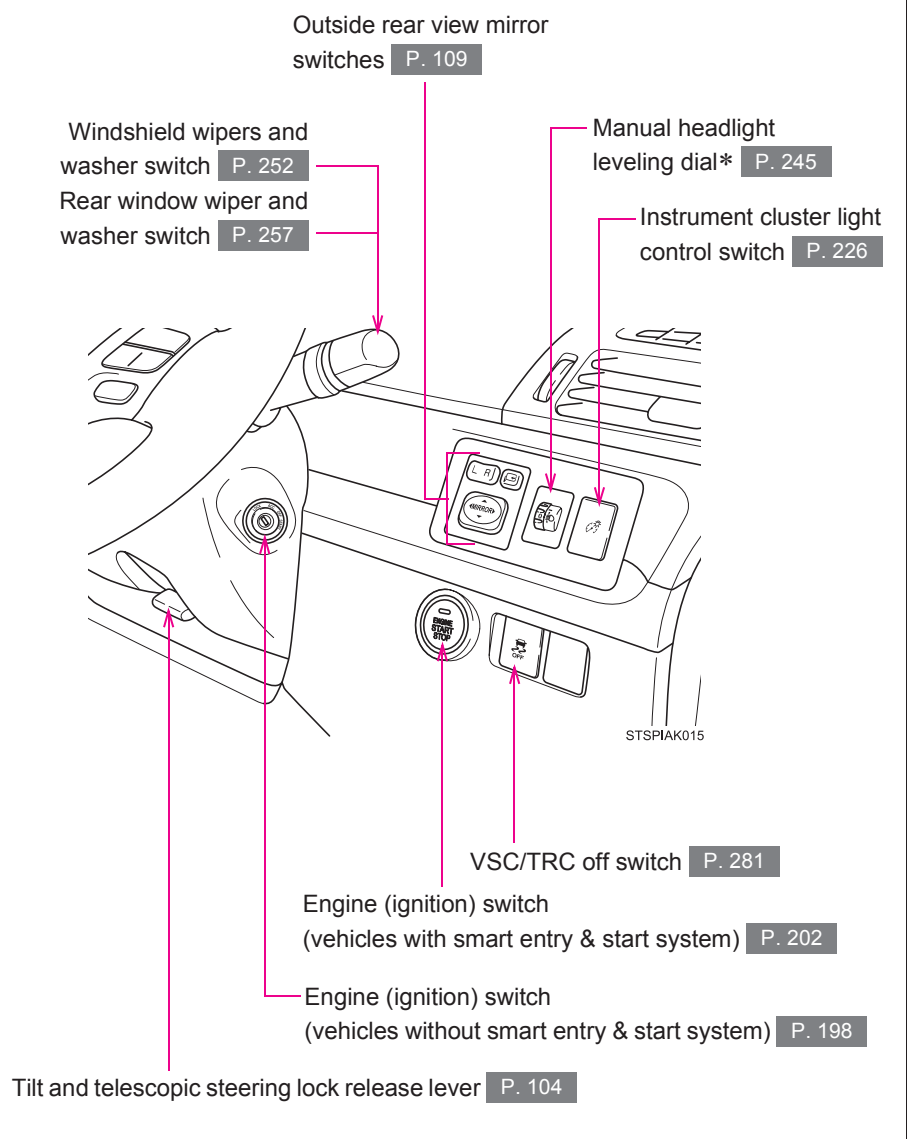

Pictorial index

Instrument panel (right-hand drive vehicles)

C

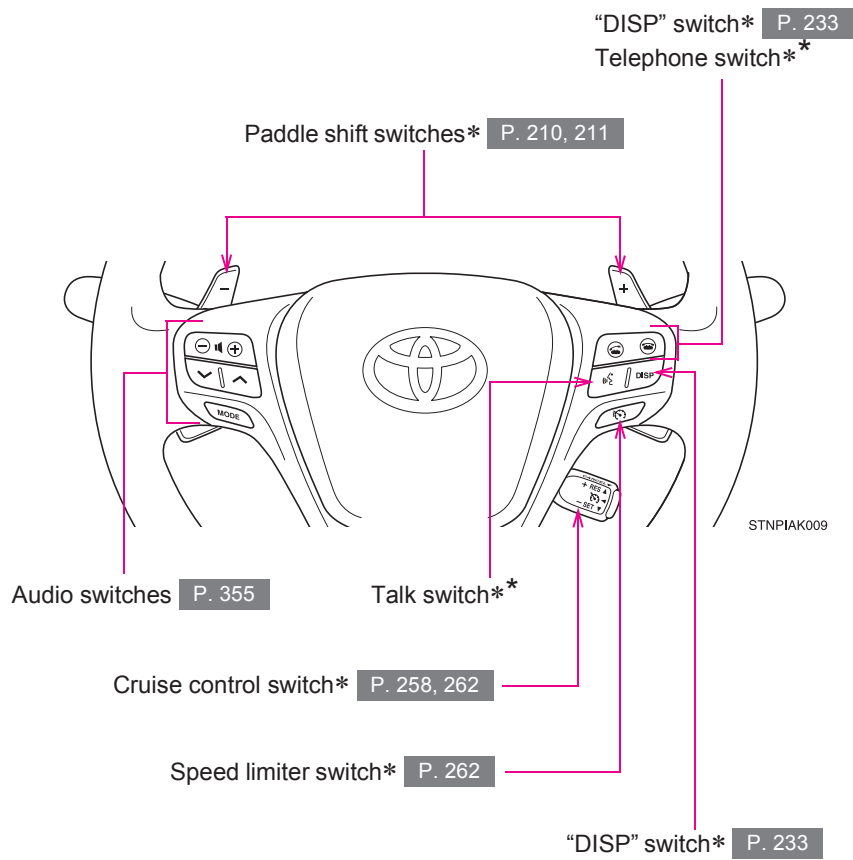

*: Refer to “Navigation and multimedia system Owner’s Manual”.
*: If equipped

► **Vehicles without third seats**

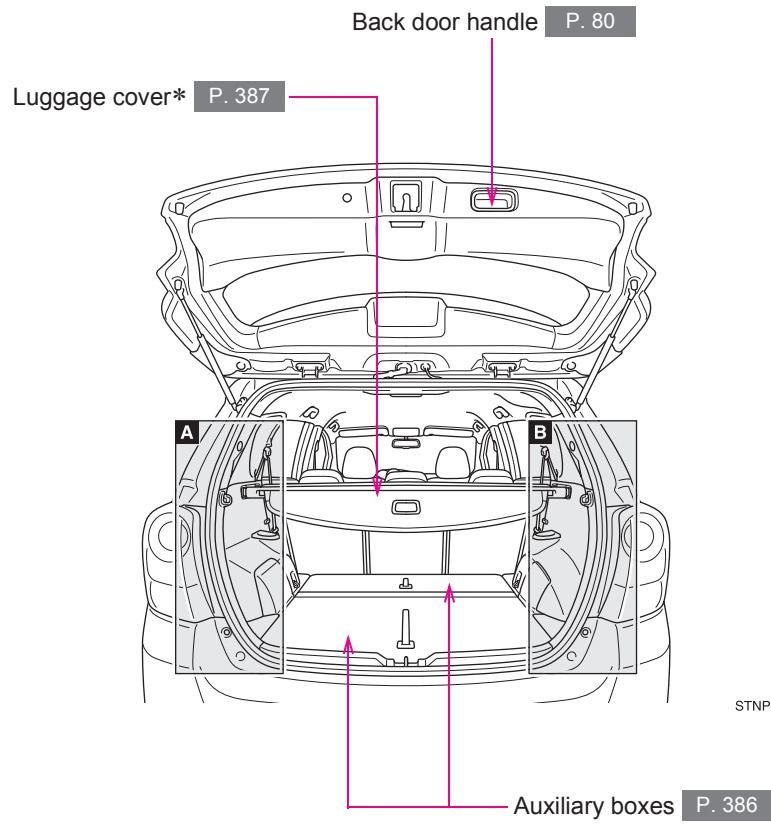

*: If equipped

► **Vehicles with third seats**

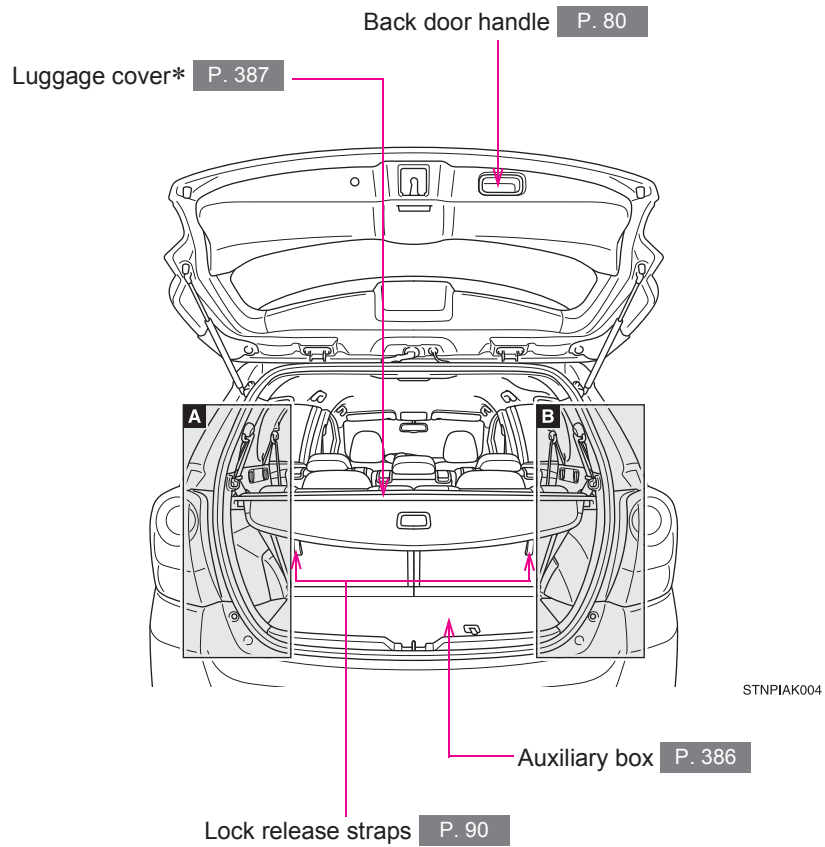

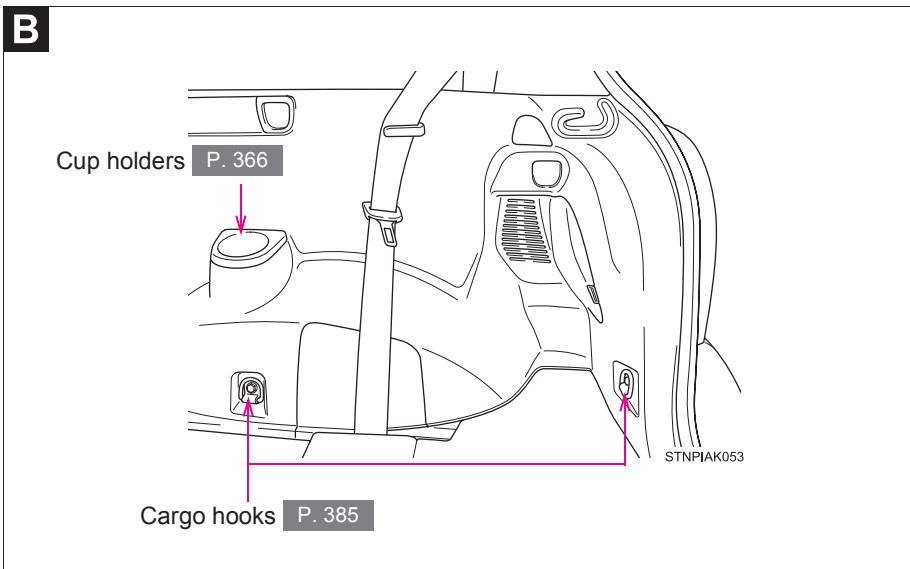
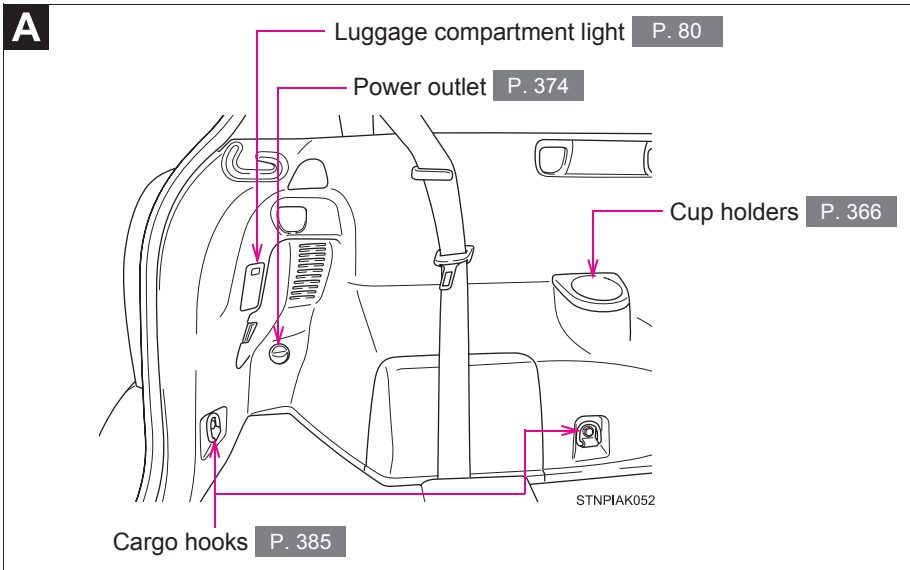

*: If equipped

For your information

Main Owner's Manual

Please note that this manual covers all models and all equipment, including options. Therefore, you may find some explanations for equipment not installed on your vehicle.

All specifications provided in this manual are current at the time of printing. However, because of the Toyota policy of continual product improvement, we reserve the right to make changes at any time without notice.

Depending on specifications, the vehicle shown in the illustrations may differ from your vehicle in terms of equipment.

Accessories, spare parts and modification of your Toyota

Both genuine Toyota and a wide variety of other spare parts and accessories for Toyota vehicles are currently available on the market. Should it be determined that any of the genuine Toyota parts or accessories supplied with the vehicle need to be replaced, Toyota Motor Corporation recommends that genuine Toyota parts or accessories, be used to replace them. Other parts or accessories of matching quality can also be used. Toyota cannot accept any liability or guarantee spare parts and accessories which are not genuine Toyota products, nor for replacement or installation involving such parts. In addition, damage or performance problems resulting from the use of non-genuine Toyota spare parts or accessories may not be covered under warranty.

Installation of an RF-transmitter system

The installation of an RF-transmitter system in your vehicle could affect electronic systems such as:

- Multiport fuel injection system/sequential multiport fuel injection system
- Cruise control system (if equipped)
- Anti-lock brake system
- SRS airbag system
- Seat belt pretensioner system

Be sure to check with any authorized Toyota dealer or repairer, or another duly qualified and equipped professional for precautionary measures or special instructions regarding installation of an RF-transmitter system.

Further information regarding frequency bands, power levels, antenna positions and installation provisions for the installation of RF-transmitters, is available on request at any authorized Toyota dealer or repairer, or another duly qualified and equipped professional.

Scrapping of your Toyota

The SRS airbag and seat belt pretensioner devices in your Toyota contain explosive chemicals. If the vehicle is scrapped with the airbags and seat belt pretensioners left as they are, this may cause an accident such as fire. Be sure to have the systems of the SRS airbag and seat belt pretensioner removed and disposed of by a qualified service shop or by any authorized Toyota dealer or repairer, or another duly qualified and equipped professional, before you scrap your vehicle.

 CAUTION

■ **General precautions while driving**

Driving under the influence: Never drive your vehicle when under the influence of alcohol or drugs that have impaired your ability to operate your vehicle. Alcohol and certain drugs delay reaction time, impair judgment and reduce coordination, which could lead to an accident that could result in death or serious injury.

Defensive driving: Always drive defensively. Anticipate mistakes that other drivers or pedestrians might make and be ready to avoid accidents.

Driver distraction: Always give your full attention to driving. Anything that distracts the driver, such as adjusting controls, talking on a cellular phone or reading can result in a collision with resulting death or serious injury to you, your occupants or others.

■ **General precautions regarding children's safety**

Never leave children unattended in the vehicle, and never allow children to have or use the key.

Children may be able to start the vehicle or shift the vehicle into neutral. There is also a danger that children may injure themselves by playing with the cigarette lighter, the windows, or other features of the vehicle. In addition, heat build-up or extremely cold temperatures inside the vehicle can be fatal to children.



Your vehicle contains batteries and/or accumulators. Do not discard them into the environment but cooperate with separate collection (Directive 2006/66/EC).

Symbols used throughout this manual

Cautions & Notices

CAUTION

This is a warning against anything which may cause injury to people if the warning is ignored. You are informed about what you must or must not do in order to reduce the risk of injury to yourself and others.

NOTICE

This is a warning against anything which may cause damage to the vehicle or its equipment if the warning is ignored. You are informed about what you must or must not do in order to avoid or reduce the risk of damage to your Toyota and its equipment.

Symbols used in illustrations



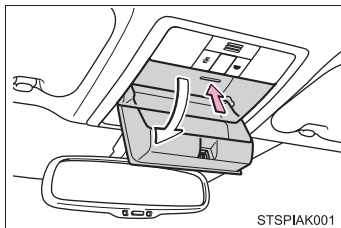

Safety symbol

The symbol of a circle with a slash through it means “Do not”, “Do not do this”, or “Do not let this happen”.



Arrows indicating operations

-  Indicates the action (pushing, turning, etc.) used to operate switches and other devices.
-  Indicates the outcome of an operation (e.g. a lid opens).

1-1. Key information		1-5. Refueling	
Keys.....	38	Opening the fuel tank cap.....	119
1-2. Opening, closing and locking the doors		1-6. Theft deterrent system	
Smart entry & start system	42	Engine immobilizer system	124
Wireless remote control	64	Double locking system.....	134
Side doors	73	Alarm	136
Back door	79	1-7. Safety information	
1-3. Adjustable components (seats, mirrors, steering wheel)		Correct driving posture	145
Front seats.....	84	SRS airbags.....	147
Rear seats	86	Child restraint systems	158
Head restraints	94	Installing child restraints ...	166
Seat belts.....	96	Airbag manual on-off system	178
Steering wheel.....	104		
Anti-glare inside rear view mirror	105		
Outside rear view mirrors	109		
1-4. Opening and closing the windows and panoramic roof shade			
Power windows.....	112		
Panoramic roof shade	116		

1-1. Key information

Keys

The following keys are provided with the vehicle.

► Vehicles without smart entry & start system (type A)

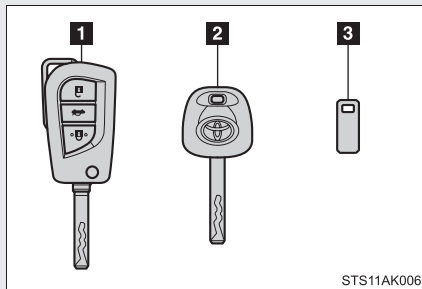

1 Key (with wireless remote control function)

Operating the wireless remote control function (→P. 64)

2 Key (without wireless remote control function)

3 Key number plate

► Vehicles without smart entry & start system (type B)

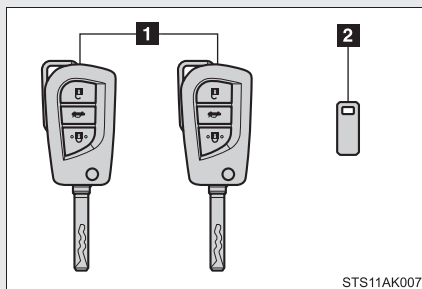

1 Keys

Operating the wireless remote control function (→P. 64)

2 Key number plate

► Vehicles with smart entry & start system

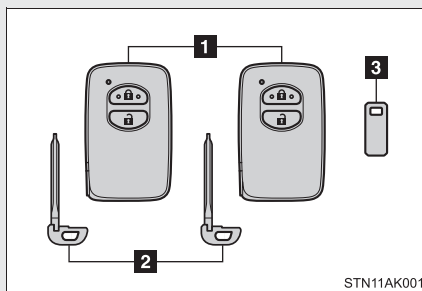

1 Electronic keys

- Operating the smart entry & start system (→P. 42)
- Operating the wireless remote control function (→P. 64)

2 Mechanical keys

3 Key number plate

Using the key (vehicles without smart entry & start system)

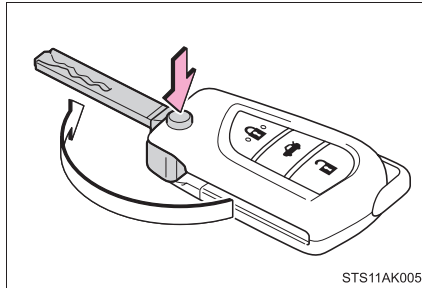

Press the button to open the key.

To stow, press the button then fold the key.

Using the mechanical key (vehicles with smart entry & start system)

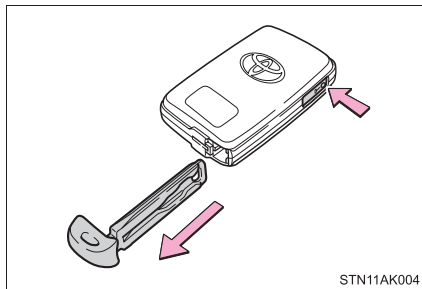

To take out the mechanical key, push the release button and take the key out.

After using the mechanical key, store it in the electronic key. Carry the mechanical key together with the electronic key. If the electronic key battery depletes or the entry function does not operate properly, you will need the mechanical key. (→P. 562)

1

Before driving

■ **When required to leave a key to the vehicle with a parking attendant (for right-hand drive vehicles with smart entry & start system)**

Lock the glove box. (→P. 363)

Remove the mechanical key for your own use and provide the attendant with the electronic key only.

■ **Key number plate**

Keep the plate in a safe place such as your wallet, not in the vehicle. In the event that a key (vehicles without smart entry & start system) or mechanical key (vehicles with smart entry & start system) is lost, a new key can be made by any authorized Toyota dealer or repairer, or another duly qualified and equipped professional, using the key number plate. (→P. 560)

■ **When riding in an aircraft**

When bringing a key with wireless remote control function onto an aircraft, make sure you do not press any buttons on the key while inside the aircraft cabin. If you are carrying the key in your bag etc., ensure that the buttons are not likely to be pressed accidentally. Pressing a button may cause the key to emit radio waves that could interfere with the operation of the aircraft.

 NOTICE

■ **To prevent key damage (vehicles without smart entry & start system)**

- Do not subject the keys to strong shocks, expose them to high temperatures by placing them in direct sunlight, or get them wet.
- Do not expose the keys to electromagnetic materials or attach any material that blocks electromagnetic waves to the key surface.
- Do not disassemble the key.

 NOTICE

■ **To prevent key damage (vehicles with smart entry & start system)**

The electronic key is a precision instrument. Be sure to observe the following.

- Do not drop the keys, subject them to strong shocks or bend them.
- Do not expose the keys to high temperatures for a long period of time.
- Do not get the keys wet or wash them in an ultrasonic washer etc.
- Do not attach metallic or magnetic materials to the keys or place the keys close to such materials.
- Do not disassemble the electronic key.
- Do not put a sticker or equivalent on the key surface.
- Do not place the key near objects that produce magnetic fields, such as TVs, audio systems, induction cookers, or medical electrical equipment, such as low-frequency therapy equipment.

■ **When carrying the keys (vehicles with smart entry & start system)**

Do not place the key within 0.1 m (0.33 ft.) of any other electric appliances when their power is on. Otherwise, the key may not operate properly due to radio wave interference from the appliances.

■ **When bringing the vehicle to your Toyota dealer or repairer, or another duly qualified and equipped professional due to problems with the smart entry & start system (vehicles with smart entry & start system)**

Bring in all electronic keys of the vehicle.

■ **When the key is lost**

If a key is lost, there is a high risk of the vehicle being stolen. Bring all remaining electric keys and immediately consult your Toyota dealer or repairer, or another duly qualified and equipped professional.

1-2. Opening, closing and locking the doors Smart entry & start system*

The following operations can be performed simply by carrying the electronic key on your person, for example in your pocket.
(The driver should always carry the electronic key.)

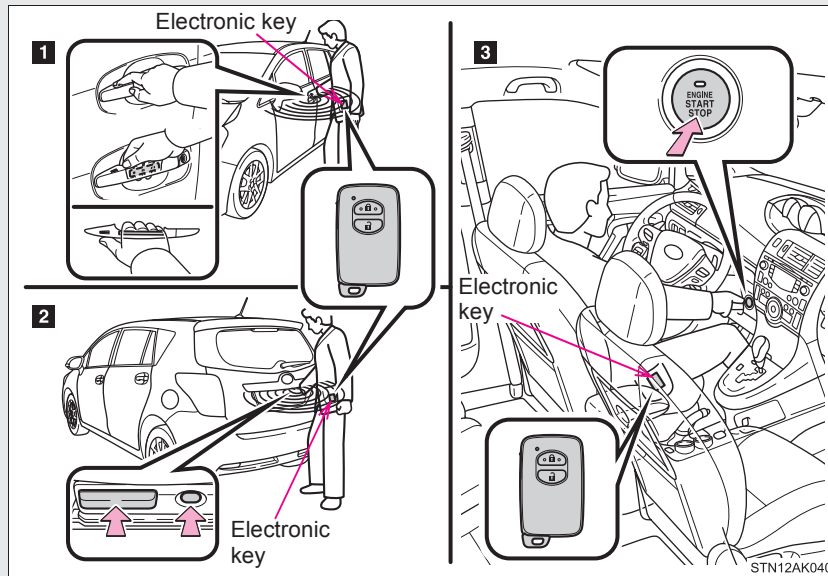

- 1** Unlocks and locks the doors and back door (→P. 43)
- 2** Unlocks and locks the doors and back door (→P. 43)
- 3** Starts and stops the engine (→P. 202)

*: If equipped

Unlocking and locking the doors (front door handles only)

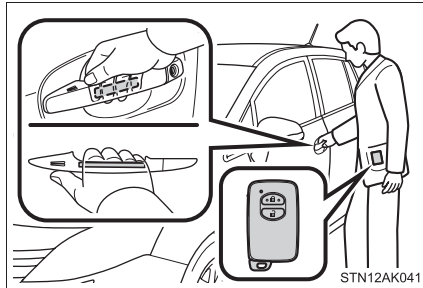

Grip the handle to unlock the doors.

Make sure to touch the sensor on the back of the handle.

The doors cannot be unlocked for 3 seconds after they are locked.

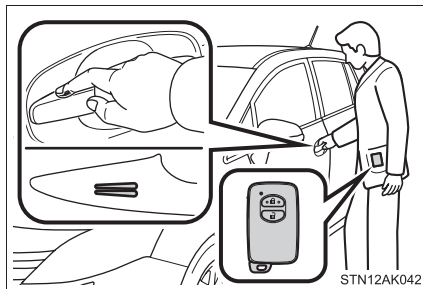

Touch the sensor area to lock the doors.

Check that the door is securely locked.

Unlocking and locking the back door

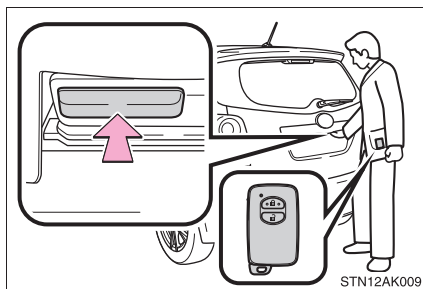

Press the unlock button to unlock the doors.

Press and hold the button for 1 second to open the back door.

The doors cannot be unlocked for 3 seconds after they are locked.

Lock the back door again when you leave the vehicle. The back door will not lock automatically after it has been opened and then closed.

1

Before driving

1-2. Opening, closing and locking the doors

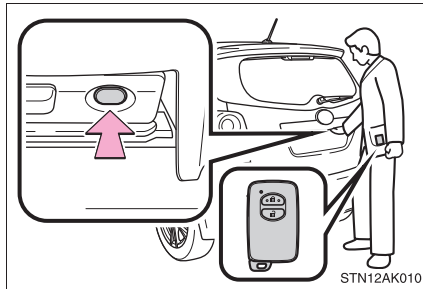

Press the lock button to lock the doors.

Check that the door is securely locked.

Antenna location and effective range

■ Antenna location

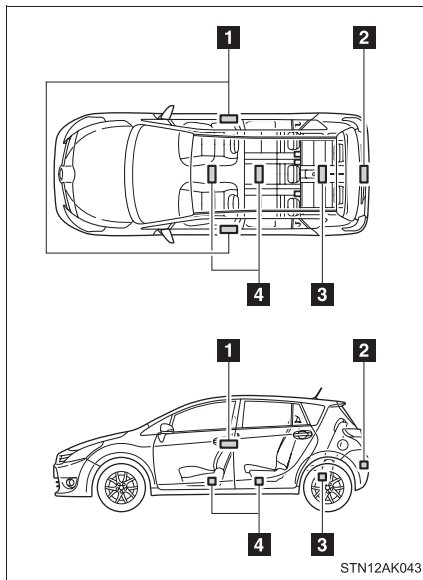

- 1** Antennas outside cabin
- 2** Antenna outside luggage compartment
- 3** Antenna inside luggage compartment
- 4** Antennas inside cabin

■ **Effective range (areas within which the electronic key is detected)**

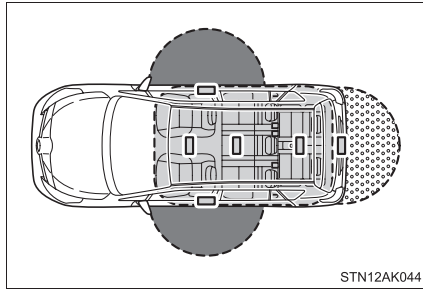

- When locking or unlocking the side doors

The system can be operated when the electronic key is within about 0.7 m (2.3 ft.) of either of the outside front door handles. (Only the doors detecting the key can be operated.)

- When starting the engine or changing “ENGINE START STOP” switch modes

The system can be operated when the electronic key is inside the vehicle.

- When locking or unlocking the back door

The system can be operated when the electronic key is within about 0.7 m (2.3 ft.) of the back door opener switch.

1

Before driving

■ **Operation signals**

The emergency flashers flash to indicate that the doors have been locked/unlocked. (Locked: Once; Unlocked: Twice)

■ **If the doors cannot be locked with the upper lock sensor of the door handle...**

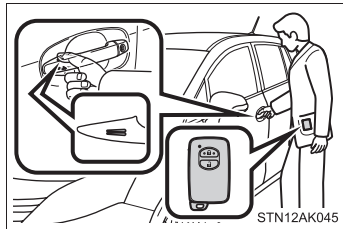

If the doors cannot be locked by touching the lock sensor provided on the upper edge of a door handle, simultaneously touch the lock sensors provided on the upper and lower edges of the door handle.

■ **Battery-saving function**

The battery-saving function will be activated in order to prevent the electronic key battery and the vehicle battery from being discharged while the vehicle is not in operation for a long time.

- In the following situations, the smart entry & start system may take some time to unlock the doors.
 - The electronic key has been left in an area of approximately 2 m (6 ft.) of the outside of the vehicle for 10 minutes or longer.
 - The smart entry & start system has not been used for 5 days or longer.
- If the smart entry & start system has not been used for 14 days or longer, the doors cannot be unlocked at any doors except the driver door. In this case, take hold of the driver door handle, or use the wireless remote control or the mechanical key, to unlock the doors.

■ **Electronic key battery depletion**

- The standard battery life is 1 to 2 years.
- If the battery becomes low, an alarm will sound in the cabin when the engine stops. (→P. 516)
- Since the electronic key receives radio waves all the time, the key battery will be depleted even when the electronic key is not being used. If any of the following problems occurs, it is assumed that the key battery has been depleted. Replace it with a new battery.
 - The smart entry & start system or wireless remote control does not work
 - The operating range has narrowed
 - The electronic key LED light does not come on
- To prevent the electronic key battery from being depleted significantly, do not place the key within 1 m (3 ft.) of the following electrical appliances, which produce magnetism.
 - TVs
 - Personal computers
 - Mobile and cordless phones, and their battery chargers
 - Lamps
 - Induction cookers

■ **To operate the system properly**

Make sure to carry the electronic key when operating the system.

■ **Note for electronic key operation**

- Do not get the electronic key too close to the vehicle when operating the system from the outside of the vehicle. Depending on the position and holding conditions of the electronic key, the key may not be detected correctly and the system may not operate properly. (The alarm may go off accidentally, or the door lock prevention may not function.)
- Even when the electronic key is within the effective range (detection areas), the system may not operate properly in the following cases.
 - When locking or unlocking the doors, the electronic key is too close to a door window or door handle, near the ground, or in a high place.
 - The electronic key is on the instrument panel, interior floor, or in a door pocket, or inside the glove box.

1-2. Opening, closing and locking the doors

- Do not leave the electronic key on top of the instrument panel or near the door pockets when exiting the vehicle. Depending on the radio wave reception conditions, it may be detected by the antenna outside the cabin and the door will become lockable from the outside, possibly trapping the electronic key inside the vehicle.

■ Special note for smart entry & start system

- When the electronic key is in the operating range, anyone can lock and unlock the doors even without having the electronic key. However, the unlocking operation will not be active at a door that has not detected the electronic key.
- When the electronic key is in the operating range and the door handles get soaked with water due to car washing or heavy rain, the doors may be locked or unlocked. If the doors are unlocked, the doors will automatically be locked again when no door operations occur in approximately 30 seconds.
- If the electronic key is inside or near the vehicle and if the doors are locked using the wireless remote control, the doors may not be unlocked with the smart entry & start system. In this case, unlock the doors using the wireless remote control.

■ Note for door locking operation

- When touching a lock sensor to lock the doors while wearing gloves, the response may be slow or the doors may not be locked. In this case, touch the lock sensor without wearing a glove.
- When door handles get wet while washing the vehicle with the electronic key on your person, the doors may be locked and unlocked repeatedly. In this case, keep the electronic key 2 m (6 ft.) or more away from the vehicle while washing (pay attention to key theft).
- When the electronic key is inside the vehicle and door handles get wet due to a car wash, a warning message stating that the key is in the cabin may appear on the multi-information display, interior and exterior alarms may sound. In this case, lock the doors to stop the alarms.

- A lock sensor covered with ice, snow or mud may not work properly. In this case, remove the ice, snow or mud from the lock sensor surface and then touch the sensor again, or unlock the doors using the lock sensor located on the lower edge of the door handle.
- Fingernails may come into contact with a door when taking hold of a door handle. Be careful not to damage the door surface or your fingernails.

■ **Note for door unlocking operation**

- The doors may not be unlocked when a door handle is operated quickly, or if you suddenly enter the operating range of the exterior antenna and operate a door handle. In this case, return the door handle to its original position, unlock the doors again, and then check that the doors are unlocked before pulling the door handle.
- When taking hold of a door handle while wearing gloves, the unlocking response may become slow or the doors may not be unlocked.
- If there is another electronic key in the operating range, the response time to unlock the doors after a door handle is taken hold of may become longer.

■ **When the vehicle is not driven for extended periods**

- To prevent theft of the vehicle, do not leave the electronic key within 2 m (6 ft.) of the vehicle.
- The smart entry & start system can be disabled. (→P. 602)

■ **Security feature**

If a door is not opened within approximately 30 seconds after the vehicle is unlocked, the security feature automatically locks the vehicle again.

1-2. Opening, closing and locking the doors

■ Alarms and warning indicators

A combination of exterior and interior alarms as well as warnings displayed on the multi-information display are used to prevent theft of the vehicle and unforeseeable accidents resulting from erroneous operation. Take appropriate measures in response to any warning indications on the multi-information display. (→P. 509)

The following table describes circumstances and correction procedures when only alarms are sounded.

Alarm	Situation	Correction procedure
Exterior alarm sounds once for 5 seconds	Tried to lock the vehicle using the entry function while a door is open.	Close all of the doors and lock the doors again.
Interior alarm pings continuously	Turned the "ENGINE START STOP" switch to ACCESSORY mode while the driver's door is open. (Opened the driver's door when the "ENGINE START STOP" switch is in ACCESSORY mode.)	Turn the "ENGINE START STOP" switch off and close the driver's door.
	Turned the "ENGINE START STOP" switch off while the driver's door is open.	Close the driver's door.

■ Note for vehicle battery disconnection and reconnection

- When the doors are attempted to be unlocked by means of the smart entry & start system just after the vehicle battery has been reconnected, it may fail. In this case, use the wireless remote control or mechanical key to unlock and lock the doors.
- The first engine start since the last time the vehicle battery was reconnected may fail. The engine will start from the second attempt, so it is not a malfunction.

- The status of the “ENGINE START STOP” switch remains stored in the vehicle memory. Therefore, after the vehicle battery is reconnected, the vehicle will return to the state before the battery was disconnected. When the battery needs to be disconnected, turn the “ENGINE START STOP” switch off before disconnecting the battery.

If the “ENGINE START STOP” switch status before the vehicle battery was disconnected is unknown, pay due attention to the vehicle when the battery is reconnected.

■ **If the smart entry & start system does not operate properly**

- Locking and unlocking the doors: Use the mechanical key. (→P. 562)
- Starting the engine: →P. 563

■ **When the electronic key battery is fully depleted**

→P. 453

■ **Customization that can be configured at any authorized Toyota dealer or repairer, or another duly qualified and equipped professional**

Settings (e.g. smart entry & start system) can be deactivated.

(Customizable features →P. 602)

For the information about the door locking/unlocking operations and the engine start procedure when the smart entry & start system has been disabled, refer to “If the electronic key does not work properly”. (→P. 562)

1-2. Opening, closing and locking the doors

■ Certification for the smart entry & start system

Hereby, Toyota Motor Corporation, declares that this TMLF8-9 is in compliance with the essential requirements and other relevant provisions of Directive 1999/5/EC.

TOYOTA

TOYOTA MOTOR CORPORATION

1, TOYOTA-CHO, TOYOTA, AICHI, 471-8571 (Head Office)
or 471-8572 (Research & Development Group) JAPAN
TEL: +81-565-28-2121

R&TTE Declaration of Conformity

We,

Manufacturer's Name: TOYOTA MOTOR CORPORATION
Manufacturer's Address: 1, Toyota -cho, Toyota, Aichi, 471-8572, Japan

hereby declare under our sole responsibility that the product:

Product Name: LF Oscillator
Product Model: TMLF8-9

to which this declaration relates is in conformity with the essential requirements and other relevant requirements of the R&TTE Directive (1999/5/EC). The product is compliant with the following standards and/or other normative documents:

-Health & safety requirements: EN60950-1
-EMC requirements EN 301 489-01 & EN 301 489-03
-Effective uses of radio spectrum: EN 300 330-2

Supplementary information:

* CE mark	
* Member states intended for use	EU and EFTA

Date: May 16, 2008

Signature: 
Takaaki Enomoto

1-2. Opening, closing and locking the doors

Hereby, Toyota Motor Corporation, declares that this TMLF8-9 is in compliance with the essential requirements and other relevant provisions of Directive 1999/5/EC.
Toyota Motor Corporation vakuuttaa täten että TMLF8-9 tyyppinen laite on direktiivin 1999/5/EY oleellisten vaatimusten ja sitä koskevien direktiivin muiden ehtojen mukainen.
Hierbij verklaart Toyota Motor Corporation dat het toestel TMLF8-9 in overeenstemming is met de essentiële eisen en de andere relevante bepalingen van richtlijn 1999/5/EG.
Par la présente Toyota Motor Corporation déclare que l'appareil TMLF8-9 est conforme aux exigences essentielles et aux autres dispositions pertinentes de la directive 1999/5/CE.
Härmed intygar Toyota Motor Corporation att denna TMLF8-9 står i överensstämmelse med de väsentliga egenskapskrav och övriga relevanta bestämmelser som framgår av direktiv 1999/5/EG.
Undertegnede Toyota Motor Corporation erklærer herved, at følgende udstyr TMLF8-9 overholder de væsentlige krav og øvrige relevante krav i direktiv 1999/5/EF.
Hiermit erklärt Toyota Motor Corporation, dass sich das Gerät TMLF8-9 in Übereinstimmung mit den grundlegenden Anforderungen und den übrigen einschlägigen Bestimmungen der Richtlinie 1999/5/EG befindet.
ΜΕ ΤΗΝ ΠΑΡΟΥΣΑ Toyota Motor Corporation ΔΗΛΩΝΕΙ ΟΤΙ ΤΜΛF8-9 ΣΥΜΜΟΡΦΩΝΕΤΑΙ ΠΡΟΣ ΤΙΣ ΟΥΣΙΩΔΕΙΣ ΑΠΑΙΤΗΣΕΙΣ ΚΑΙ ΤΙΣ ΛΟΙΠΕΣ ΣΧΕΤΙΚΕΣ ΔΙΑΤΑΞΕΙΣ ΤΗΣ ΟΔΗΓΙΑΣ 1999/5/ΕΚ.
Con la presente Toyota Motor Corporation dichiara che questo TMLF8-9 è conforme ai requisiti essenziali ed alle altre disposizioni pertinenti stabilite dalla direttiva 1999/5/CE.
Por medio de la presente Toyota Motor Corporation declara que el TMLF8-9 cumple con los requisitos esenciales y cualesquiera otras disposiciones aplicables o exigibles de la Directiva 1999/5/CE.
Toyota Motor Corporation declara que este TMLF8-9 está conforme com os requisitos essenciais e outras disposições da Directiva 1999/5/CE.
Hawnhekk, Toyota Motor Corporation, jiddikjara li dan TMLF8-9 jikkonforma mal-htigijiet essenzjali u ma provvedimenti oħrajn relevanti li hemm fid-Dirrettiva 1999/5/EC.

1

Before driving

1-2. Opening, closing and locking the doors

Käesolevaga kinnitab Toyota Motor Corporation seadme TMLF8-9 vastavust direktiivi 1999/5/EÜ põhinõuetele ja nimetatud direktivist tulenevatele teistele asjakohastele sätetele.
Alulírott, Toyota Motor Corporation nyilatkozom, hogy a TMLF8-9 megfelel a vonatkozó alapvető követelményeknek és az 1999/5/EC irányelv egyéb előírásainak.
Toyota Motor Corporation tímto vyhlasuje, že TMLF8-9 splňa základné požiadavky a všetky príslušné ustanovenia Smernice 1999/5/ES.
Toyota Motor Corporation tímto prohlašuje, že tento TMLF8-9 je ve shodě se základními požadavky a dalšími příslušnými ustanoveními směrnice 1999/5/ES.
Toyota Motor Corporation izjavlja, da je ta TMLF8-9 v skladu z bistvenimi zahtevami in ostalimi relevantnimi določili direktive 1999/5/ES.
Šiuo Toyota Motor Corporation deklaruoja, kad šis TMLF8-9 atitinka esminius reikalavimus ir kitas 1999/5/EB Direktyvos nuostatas.
Ar šo Toyota Motor Corporation deklarē, ka TMLF8-9 atbilst Direktīvas 1999/5/EK būtiskajām prasībām un citiem ar to saistītajiem noteikumiem.
Niniejszym Toyota Motor Corporation oświadcza, że TMLF8-9 jest zgodny z zasadniczymi wymogami oraz pozostałymi stosownymi postanowieniami Dyrektywy 1999/5/EC.
Hér með lýsir Toyota Motor Corporation yfir því að TMLF8-9 er í samræmi við grunnkröfur og aðrar kröfur, sem gerðar eru í tilskipun 1999/5/EC.
Toyota Motor Corporation erklærer herved at utstyret TMLF8-9 er i samsvar med de grunnleggende krav og øvrige relevante krav i direktiv 1999/5/EF.
С настоящето, Toyota Motor Corporation, декларира, че TMLF8-9 е в съответствие със съществените изисквания и другите приложими разпоредби на Директива 1999/5/EC.
Prin prezenta, Toyota Motor Corporation, declară că aparatul TMLF8-9 este în conformitate cu cerințele esențiale și cu alte prevederi pertinente ale Directivei 1999/5/CE.

1-2. Opening, closing and locking the doors

Ovim, Toyota Motor Corporation, izjavljuje da ovaj TMLF8-9 je usklađen sa bitnim zahtjevima i drugim relevantnim odredbama Direktive 1999/5/EC.

Nepermjet kesaj, Toyota Motor Corporation, deklaruj qe ky TMLF8-9 eshte ne pajtim me kerkesat thelbesore dhe dispozitat e tjera perkatese te Direktives 1999/5/EC.

Ovim Toyota Motor Corporation, izjavljuje da je TMLF8-9 u skladu s bitnim zahtjevima i drugim relevantnim odredbama Direktive 1999/5/EC i Pravilnika o RiTT opremi (NN 25/2012).

Ovim, Toyota Motor Corporation, deklarirše da je TMLF8-9 u skladu sa osnovnim zahtjevima i ostalim relevantnim odredbama Direktive 1999/5/EC.

1

Before driving

1-2. Opening, closing and locking the doors

The DECLARATION of CONFORMITY (DoC) is available at the following address:

<http://www.tokai-rika.co.jp/pc/>



Hereby, TRCZ s.r.o., declares that this B75EA is in compliance with the essential requirements and other relevant provisions of Directive 1999/5/EC.
TRCZ s.r.o. vakuuttaa täten että B75EA tyyppinen laite on direktiivin 1999/5/EY oleellisten vaatimusten ja sitä koskevien direktiivin muiden ehtojen mukainen.
Hierbij verklaart TRCZ s.r.o. dat het toestel B75EA in overeenstemming is met de essentiële eisen en de andere relevante bepalingen van richtlijn 1999/5/EG.
Par la présente TRCZ s.r.o. déclare que l'appareil B75EA est conforme aux exigences essentielles et aux autres dispositions pertinentes de la directive 1999/5/CE.
Härmed intygar TRCZ s.r.o. att denna B75EA står i överensstämmelse med de väsentliga egenskapskrav och övriga relevanta bestämmelser som framgår av direktiv 1999/5/EG.
Undertegnede TRCZ s.r.o. erklærer herved, at følgende udstyr B75EA overholder de væsentlige krav og øvrige relevante krav i direktiv 1999/5/EF.
Hiermit erklärt TRCZ s.r.o., dass sich das Gerät B75EA in Übereinstimmung mit den grundlegenden Anforderungen und den übrigen einschlägigen Bestimmungen der Richtlinie 1999/5/EG befindet.
ΜΕ ΤΗΝ ΠΑΡΟΥΣΑ TRCZ s.r.o. ΔΗΛΩΝΕΙ ΟΤΙ Β75ΕΑ ΣΥΜΜΟΡΦΩΝΕΤΑΙ ΠΡΟΣ ΤΙΣ ΟΥΣΙΩΔΕΙΣ ΑΠΑΙΤΗΣΕΙΣ ΚΑΙ ΤΙΣ ΛΟΙΠΕΣ ΣΧΕΤΙΚΕΣ ΔΙΑΤΑΞΕΙΣ ΤΗΣ ΟΔΗΓΙΑΣ 1999/5/ΕΚ.
Con la presente TRCZ s.r.o. dichiara che questo B75EA è conforme ai requisiti essenziali ed alle altre disposizioni pertinenti stabilite dalla direttiva 1999/5/CE.
Por medio de la presente TRCZ s.r.o. declara que el B75EA cumple con los requisitos esenciales y cualesquiera otras disposiciones aplicables o exigibles de la Directiva 1999/5/CE.

1-2. Opening, closing and locking the doors

TRCZ s.r.o. declara que este B75EA está conforme com os requisitos essenciais e outras disposições da Directiva 1999/5/CE.
Hawnhekk, TRCZ s.r.o., jiddikjara li dan B75EA jikkonforma mal-htigijiet essenzjali u ma provvedimenti oħrajn relevanti li hemm fid-Dirrettiva 1999/5/EC.
Käesolevaga kinnitab TRCZ s.r.o. seadme B75EA vastavust direktiivi 1999/5/EÜ põhinõuetele ja nimetatud direktiivist tulenevatele teistele asjakohastele sätetele.
Alulírott, TRCZ s.r.o. nyilatkozom, hogy a B75EA megfelel a vonatkozó alapvető követelményeknek és az 1999/5/EC irányelv egyéb előírásainak.
TRCZ s.r.o. týmto vyhlasuje, že B75EA splňa základné požiadavky a všetky príslušné ustanovenia Smernice 1999/5/ES.
TRCZ s.r.o. tímto prohlašuje, že tento B75EA je ve shodě se základními požadavky a dalšími příslušnými ustanoveními směrnice 1999/5/ES.
TRCZ s.r.o. izjavlja, da je ta B75EA v skladu z bistvenimi zahtevami in ostalimi relevantnimi določili direktive 1999/5/ES.
Šiuo TRCZ s.r.o. deklaruoja, kad šis B75EA atitinka esminius reikalavimus ir kitas 1999/5/EB Direktyvos nuostatas.
Ar šo TRCZ s.r.o. deklarē, ka B75EA atbilst Direktīvas 1999/5/EK būtiskajām prasībām un citiem ar to saistītajiem noteikumiem.
Niniejszym TRCZ s.r.o. oświadcza, że B75EA jest zgodny z zasadniczymi wymogami oraz pozostałymi stosownymi postanowieniami Dyrektywy 1999/5/EC.
Hér með lýsir TRCZ s.r.o. yfir því að B75EA er í samræmi við grunnkröfur og aðrar kröfur, sem gerðar eru í tilskipun 1999/5/EC.
TRCZ s.r.o. erklærer herved at utstyret B75EA er i samsvar med de grunnleggende krav og øvrige relevante krav i direktiv 1999/5/EF.

1

Before driving

1-2. Opening, closing and locking the doors

<p>С настоящето, TRCZ s.r.o., декларира, че B75EA е в съответствие със съществените изисквания и другите приложими разпоредби на Директива 1999/5/EC.</p>
<p>Prin prezenta, TRCZ s.r.o., declară că aparatul B75EA este în conformitate cu cerințele esențiale și cu alte prevederi pertinente ale Directivei 1999/5/CE.</p>
<p>Ovim, TRCZ s.r.o., izjavljuje da ovaj B75EA je usklađen sa bitnim zahtjevima i drugim relevantnim odredbama Direktive 1999/5/EC.</p>
<p>Nepermjet kesaj, TRCZ s.r.o., deklaruj qe ky B75EA eshte ne pajtim me kerkesat thelbesore dhe dispozitat e tjera perkatese te Direktives 1999/5/EC.</p>
<p>Ovim TRCZ s.r.o., izjavljuje da je B75EA u skladu s bitnim zahtjevima i drugim relevantnim odredbama Direktive 1999/5/EC i Pravilnika o RiTT opremi (NN 25/2012).</p>
<p>Ovim, TRCZ s.r.o., deklarise da je B75EA u skladu sa osnovnim zahtevima i ostalim relevantnim odredbama Direktive 1999/5/EC.</p>

The DECLARATION of CONFORMITY (DoC) is available at the following address:

<http://www.tokai-rika.co.jp/pc/>



Hereby, TRCZ s.r.o., declares that this B76UA is in compliance with the essential requirements and other relevant provisions of Directive 1999/5/EC.
TRCZ s.r.o. vakuuttaa täten että B76UA tyyppinen laite on direktiivin 1999/5/EY oleellisten vaatimusten ja sitä koskevien direktiivin muiden ehtojen mukainen.
Hierbij verklaart TRCZ s.r.o. dat het toestel B76UA in overeenstemming is met de essentiële eisen en de andere relevante bepalingen van richtlijn 1999/5/EG.
Par la présente TRCZ s.r.o. déclare que l'appareil B76UA est conforme aux exigences essentielles et aux autres dispositions pertinentes de la directive 1999/5/CE.
Härmed intygar TRCZ s.r.o. att denna B76UA står i överensstämmelse med de väsentliga egenskapskrav och övriga relevanta bestämmelser som framgår av direktiv 1999/5/EG.
Undertegnede TRCZ s.r.o. erklærer herved, at følgende udstyr B76UA overholder de væsentlige krav og øvrige relevante krav i direktiv 1999/5/EF.
Hiermit erklärt TRCZ s.r.o., dass sich das Gerät B76UA in Übereinstimmung mit den grundlegenden Anforderungen und den übrigen einschlägigen Bestimmungen der Richtlinie 1999/5/EG befindet.
ΜΕ ΤΗΝ ΠΑΡΟΥΣΑ TRCZ s.r.o. ΔΗΛΩΝΕΙ ΟΤΙ Β76UA ΣΥΜΜΟΡΦΩΝΕΤΑΙ ΠΡΟΣ ΤΙΣ ΟΥΣΙΩΔΕΙΣ ΑΠΑΙΤΗΣΕΙΣ ΚΑΙ ΤΙΣ ΛΟΙΠΕΣ ΣΧΕΤΙΚΕΣ ΔΙΑΤΑΞΕΙΣ ΤΗΣ ΟΔΗΓΙΑΣ 1999/5/ΕΚ.
Con la presente TRCZ s.r.o. dichiara che questo B76UA è conforme ai requisiti essenziali ed alle altre disposizioni pertinenti stabilite dalla direttiva 1999/5/CE.
Por medio de la presente TRCZ s.r.o. declara que el B76UA cumple con los requisitos esenciales y cualesquiera otras disposiciones aplicables o exigibles de la Directiva 1999/5/CE.

1

Before driving

1-2. Opening, closing and locking the doors

TRCZ s.r.o. declara que este B76UA está conforme com os requisitos essenciais e outras disposições da Directiva 1999/5/CE.
Hawnhekk, TRCZ s.r.o., jiddikjara li dan B76UA jikkonforma mal-htigijiet essenzjali u ma provvedimenti oħrajn relevanti li hemm fid-Dirrettiva 1999/5/EC.
Käesolevaga kinnitab TRCZ s.r.o. seadme B76UA vastavust direktiivi 1999/5/EÜ põhinõuetele ja nimetatud direktiivist tulenevatele teistele asjakohastele sätetele.
Alulírott, TRCZ s.r.o. nyilatkozom, hogy a B76UA megfelel a vonatkozó alapvető követelményeknek és az 1999/5/EC irányelv egyéb előírásainak.
TRCZ s.r.o. tímto vyhlasuje, že B76UA splňa základné požiadavky a všetky príslušné ustanovenia Smernice 1999/5/ES.
TRCZ s.r.o. tímto prohlašuje, že tento B76UA je ve shodě se základními požadavky a dalšími příslušnými ustanoveními směrnice 1999/5/ES.
TRCZ s.r.o. izjavlja, da je ta B76UA v skladu z bistvenimi zahtevami in ostalimi relevantnimi določili direktive 1999/5/ES.
Šiuo TRCZ s.r.o. deklaruoja, kad šis B76UA atitinka esminius reikalavimus ir kitas 1999/5/EB Direktyvos nuostatas.
Ar šo TRCZ s.r.o. deklarē, ka B76UA atbilst Direktīvas 1999/5/EK būtiskajām prasībām un citiem ar to saistītajiem noteikumiem.
Niniejszym TRCZ s.r.o. oświadcza, że B76UA jest zgodny z zasadniczymi wymogami oraz pozostałymi stosownymi postanowieniami Dyrektywy 1999/5/EC.
Hér með lýsir TRCZ s.r.o. yfir því að B76UA er í samræmi við grunnkröfur og aðrar kröfur, sem gerðar eru í tilskipun 1999/5/EC.
TRCZ s.r.o. erklærer herved at utstyret B76UA er i samsvar med de grunnleggende krav og øvrige relevante krav i direktiv 1999/5/EF.

1-2. Opening, closing and locking the doors

<p>С настоящето, TRCZ s.r.o., декларира, че B76UA е в съответствие със съществените изисквания и другите приложими разпоредби на Директива 1999/5/EC.</p>
<p>Prin prezenta, TRCZ s.r.o., declară că aparatul B76UA este în conformitate cu cerințele esențiale și cu alte prevederi pertinente ale Directivei 1999/5/CE.</p>
<p>Ovim, TRCZ s.r.o., izjavljuje da ovaj B76UA je usklađen sa bitnim zahtjevima i drugim relevantnim odredbama Direktive 1999/5/EC.</p>
<p>Nepermjet kesaj, TRCZ s.r.o., deklaroh qe ky B76UA eshte ne pajtim me kerkesat thelbesore dhe dispozitat e tjera perkatese te Direktives 1999/5/EC.</p>
<p>Ovim TRCZ s.r.o., izjavljuje da je B76UA u skladu s bitnim zahtjevima i drugim relevantnim odredbama Direktive 1999/5/EC i Pravilnika o RiTT opremi (NN 25/2012).</p>
<p>Ovim, TRCZ s.r.o., deklarirše da je B76UA u skladu sa osnovnim zahtevima i ostalim relevantnim odredbama Direktive 1999/5/EC.</p>

1

Before driving

 CAUTION

■ **Caution regarding interference with electronic devices**

- People with implantable cardiac pacemakers, cardiac resynchronization therapy-pacemakers or implantable cardioverter defibrillators should maintain a reasonable distance between themselves and the smart entry & start system antennas. (→P. 44)

The radio waves may affect the operation of such devices. If necessary, the entry function can be disabled. Ask any authorized Toyota dealer or repairer, or another duly qualified and equipped professional for details, such as the frequency of radio waves and timing of the emitted radio waves. Then, consult your doctor to see if you should disable the entry function.

- Users of any electrical medical device other than implantable cardiac pacemakers, cardiac resynchronization therapy-pacemakers or implantable cardioverter defibrillators should consult the manufacturer of the device for information about its operation under the influence of radio waves.

Radio waves could have unexpected effects on the operation of such medical devices.

Ask any authorized Toyota dealer or repairer, or another duly qualified and equipped professional for details for disabling the entry function.

 NOTICE

■ Conditions affecting operation

The smart entry & start system uses weak radio waves. In the following situations, the communication between the electronic key and the vehicle may be affected, preventing the smart entry & start system and wireless remote control from operating properly. (Way of coping →P. 562)

- When the electronic key battery is depleted
- Near a TV tower, electric power plant, gas station, radio station, large display, airport or other facility that generates strong radio waves or electrical noise
- When a portable radio, cellular phone, cordless phone or other wireless communication device is in the vicinity
- When the electronic key has come into contact with, or is covered by a metallic object, such as the following
 - Cards on which metal sheets such as foil are attached
 - Cigarette boxes in which foil is used
 - Metallic wallets or bags
 - Coins
 - Hot packs or pocket warmers
 - Optical media such as CDs and DVDs
- When other wireless keys that emit radio waves are used in the vicinity
- When carrying the electronic key together with the following devices
 - Another vehicle's electronic key or a wireless key that emits radio waves
 - Personal computers or PDAs
 - Digital audio players
 - Hand-held game consoles
- If window tint with a metallic content or metallic objects are attached to the rear window

1-2. Opening, closing and locking the doors

Wireless remote control

The wireless remote control can be used to lock and unlock the vehicle from outside the vehicle.

► Vehicles without smart entry & start system

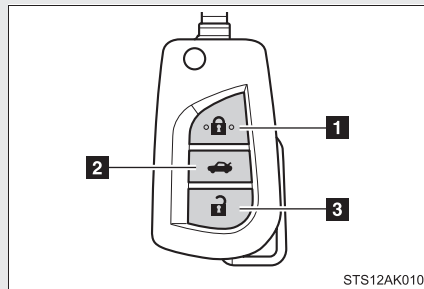

1 Locks all doors

Check that the door is securely locked.

2 Unlocks the back door

Lock the back door again when you leave the vehicle. They will not lock automatically after they have been opened and then closed.

3 Unlocks all doors

► Vehicles with smart entry & start system

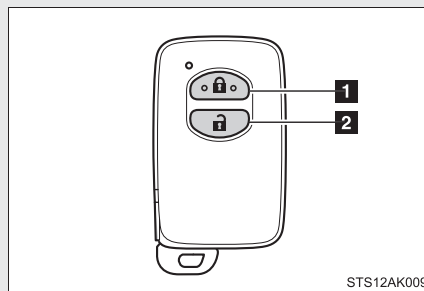

1 Locks all doors

Check that the door is securely locked.

2 Unlocks all doors

■ Operation signals

The emergency flashers flash to indicate that the doors have been locked/unlocked. (Locked: Once; Unlocked: Twice)

■ Door lock buzzer

If the door is not fully closed, a buzzer sounds continuously for 5 seconds if an attempt to lock the door is made. Fully close the door to stop the buzzer, and lock the vehicle once more.

■ Back door operation (vehicles without smart entry & start system)

When the back door is locked, it can be unlocked by the back door unlock button of the wireless key. Lock the back door again when you leave the vehicle. The back door will not lock automatically after it has been opened and then closed.

■ Alarm (if equipped)

Using the wireless remote control to lock the doors will set the alarm system. (→P. 136)

■ Key battery depletion

▶ Vehicles without smart entry & start system

If the wireless remote control function does not operate, the battery may be depleted. Replace the battery when necessary. (→P. 453)

▶ Vehicles with smart entry & start system

→P. 47, 453

■ Security feature

If a door is not opened within approximately 30 seconds after the vehicle is unlocked, the security feature automatically locks the vehicle again.

■ If the wireless remote control does not operate properly

▶ Vehicles without smart entry & start system

Locking and unlocking the doors: Use the key. (→P. 73)

▶ Vehicles with smart entry & start system

→P. 562

■ **Conditions affecting operation**

▶ **Vehicles without smart entry & start system**

The wireless remote control function may not operate normally in the following situations.

- Near a TV tower, radio station, electric power plant, airport or other facility that generates strong radio waves
- When carrying a portable radio, cellular phone or other wireless communication device
- When multiple wireless keys are in the vicinity
- When the wireless key has come into contact with, or is covered by a metallic object
- When a wireless key (that emits radio waves) is being used nearby
- When the wireless key has been left near an electrical appliance such as a personal computer
- When the wireless key battery is depleted
- If window tint with a metallic content or metallic objects are attached to the rear window

▶ **Vehicles with smart entry & start system**

→P. 63

■ **Customization that can be configured at any authorized Toyota dealer or repairer, or another duly qualified and equipped professional**

Settings (e.g. wireless remote control system) can be changed.
(Customizable features →P. 602)

■ Certification for wireless remote control (vehicles without smart entry & start system)

 Comfort and Driving Assistance Systems

Declaration of Conformity
in accordance with 1999/5/EC (R&TTE Directive)

We,

Manufacturer: Valeo Comfort and Driving Assistance
Address: 76, rue Auguste Perret
F-94046 Créteil - Cedex
France

hereby declare under our sole responsibility that the product:
Product name: RF Transmitter (Jack Knife Key)
Model No.: **A03TAA**

to which this declaration relates, complies with the essential protection requirements of R&TTE Directive (1999/5/ EC).
The product is compliant with the following standards and/or normative documents:

- Efficient use of radio spectrum: EN 300 220-1 V2.3.1 (2010-02), EN 300 220-2 V2.3.1 (2010-02)
- Electromagnetic compatibility: EN 301 489-1 V1.8.1 (2008-04), EN 301 489-3 V1.4.1 (2002-08)
- Electrical Safety: EN 60950-1: 2006 + A11:2009 + A1:2010

CE marking: **CE0682**

Créteil, October the 21th of 2014

Jérôme Hugot
Certification & Regulation

VALEO COMFORT AND DRIVING ASSISTANCE - 76 Rue Auguste Perret - ZI Europarc - 94046 Créteil Cedex - France
Tel. +33 (0)1 48 84 54 00 - Fax +33 (0)1 48 84 54 53
S.A.S. au capital de 13 387 965 Euros – 438 809 667 RCS Créteil
www.valeo.com

1

Before driving

1-2. Opening, closing and locking the doors

Česky [Czech]	Valeo Comfort and Driving Assistance tímto prohlašuje, že tento A03TAA je ve shodě se základními požadavky a dalšími příslušnými ustanoveními směrnice 1999/5/ES.
Hrvatski [Croatian]	Ovime, Valeo Comfort and Driving Assistance izjavljuje da je model A03TAA je u skladu sa osnovnim zahtjevima i drugim relevantnim odredbama Direktive 1999/5/EC.
Dansk [Danish]	Undertegnede Valeo Sécurité Habitacle erklærer herved, at følgende udstyr A03TAA overholder de væsentlige krav og øvrige relevante krav i direktiv 1999/5/EF.
Deutsch [German]	Hiermit erkläre Valeo Sécurité Habitacle, dass sich das Model A03TAA in Übereinstimmung mit den grundlegenden Anforderungen und den übrigen einschlägigen Bestimmungen der Richtlinie 1999/5/EG befindet.
Eesti [Estonian]	Käesolevaga kinnitab Valeo Sécurité Habitacle seadme A03TAA vastavust direktiivi 1999/5/EÜ põhinõuetele ja nimetatud direktiivist tulenevatele teistele asjakohastele sätetele.
English	Hereby, Valeo Sécurité Habitacle declares that the model A03TAA is in compliance with the essential requirements and other relevant provisions of Directive 1999/5/EC.
Español [Spanish]	Por medio de la presente Valeo Sécurité Habitacle declara que A03TAA cumple con los requisitos esenciales y cualesquiera otras disposiciones aplicables o exigibles de la Directiva 1999/5/CE.
Ελληνική [Greek]	Με την παρούσα Valeo Sécurité Habitacle δηλώνει ότι A03TAA συμμορφώνεται προς τις ουσιαστικές απαιτήσεις και τις λοιπές σχετικές διατάξεις της οδηγίας 1999/5/ΕΚ.
Français [French]	Par la présente Valeo Sécurité Habitacle déclare que les appareils modèle A03TAA sont conformes aux exigences essentielles et aux autres dispositions pertinentes de la directive 1999/5/CE.
Italiano [Italian]	Con la presente Valeo Sécurité Habitacle dichiara che questo A03TAA è conforme ai requisiti essenziali ed alle altre disposizioni pertinenti stabilite dalla direttiva 1999/5/CE.
Latviski [Latvian]	Ar šo Valeo Sécurité Habitacle deklarē, ka A03TAA atbilst Direktīvas 1999/5/EK būtiskajām prasībām un citiem ar to saistītajiem noteikumiem.
Lietuvių [Lithuanian]	Šiuo Valeo Sécurité Habitacle deklaruoja, kad šis A03TAA atitinka esminius reikalavimus ir kitas 1999/5/EB Direktyvos nuostatas.
Nederlands [Dutch]	Hierbij verklaart Valeo Sécurité Habitacle dat het toestel A03TAA in overeenstemming is met de essentiële eisen en de andere relevante bepalingen van richtlijn 1999/5/EG.

1-2. Opening, closing and locking the doors

Malti [Maltese]	Hawnhekk, Valeo Sécurité Habitable , jiddikjara li dan A03TAA jikkonforma mal-ftiglijiet essenzjali u ma provvedimenti oħrajn relevanti li hemm fid-Dirrettiva 1999/5/EC.
Magyar [Hungarian]	Alulírott, Valeo Sécurité Habitable nyilatkozom, hogy a A03TAA megfelel a vonatkozó alapvető követelményeknek és az 1999/5/EC irányelv egyéb előírásainak.
Polski [Polish]	Niniejszym Valeo Sécurité Habitable oświadcza, że A03TAA jest zgodny z zasadniczymi wymogami oraz pozostałymi stosownymi postanowieniami Dyrektywy 1999/5/EC.
Português [Portuguese]	Valeo Sécurité Habitable declara que este A03TAA está conforme com os requisitos essenciais e outras disposições da Directiva 1999/5/CE.
Slovensko [Slovenian]	Valeo Sécurité Habitable izjavlja, da je ta A03TAA v skladu z bistvenimi zahtevami in ostalimi relevantnimi določili direktive 1999/5/ES.
Slovenský [Slovak]	Valeo Sécurité Habitable týmto vyhlasuje, že A03TAA spĺňa základné požiadavky a všetky príslušné ustanovenia Smernice 1999/5/ES.
Suomi [Finnish]	Valeo Sécurité Habitable vakuuttaa täten että A03TAA tyyppinen laite on direktiivin 1999/5/EY oleellisten vaatimusten ja sitä koskevien direktiivin muiden ehtojen mukainen.
Svenska [Swedish]	Härmed intygar Valeo Sécurité Habitable att denna A03TAA står i överensstämmelse med de väsentliga egenskapskrav och övriga relevanta bestämmelser som framgår av direktiv 1999/5/EG.
Íslenska [Icelandic]	Hér með lýsir Valeo Sécurité Habitable yfir því að A03TAA er í samræmi við grunnkröfur og aðrar kröfur, sem gerðar eru í tilskipun 1999/5/EC.
Norsk [Norwegian]	Valeo Sécurité Habitable erklærer herved at utstyret A03TAA er i samsvar med de grunnleggende krav og øvrige relevante krav i direktiv 1999/5/EF.
Crnogorski jezik [Montenegrin]	Ovime, Valeo Comfort and Driving Assistance izjavljuje da je model A03TAA je u skladu sa osnovnim zahtjevima i drugim relevantnim odredbama Direktive 1999/5/EC.
српски [Serbian]	Овиме, Valeo Comfort and Driving Assistance изјављује да је А03ТАА модел је у складу са основним захтевима и другим релевантним одредбама Директиве 1999/5/ЕУ.

1

Before driving

1-2. Opening, closing and locking the doors

 Comfort and Driving Assistance Systems

Declaration of Conformity
in accordance with 1999/5/EC (R&TTE Directive)

We,

Manufacturer: Valeo Comfort and Driving Assistance
Address: 76, rue Auguste Perret
F-94046 Créteil - Cedex
France

hereby declare under our sole responsibility that the product:

Product name: RF Receiver
Model No.: **D603B1-A**

to which this declaration relates, complies with the essential protection requirements of R&TTE Directive (1999/5/ EC).
The product is compliant with the following standards and/or normative documents:

- Efficient use of radio spectrum:	EN 300 220-1 V2.1.1 (2006-04), EN 300 220-2 V2.1.1 (2006-04)
- Electromagnetic compatibility:	EN 301 489-1 V1.6.1 (2005-09), EN 301 489-3 V1.4.1 (2002-08)
- Electrical Safety:	EN 60950-1: 2002

CE marking: 

Créteil, October the 31th of 2014

Jérôme Hugot
Certification & Regulation

VALEO COMFORT AND DRIVING ASSISTANCE - 76 Rue Auguste Perret - ZI Europarc - 94046 Créteil Cedex - France
Tel. +33 (0)1 48 84 54 00 - Fax +33 (0)1 48 84 54 53
S.A.S. au capital de 13 387 965 Euros – 438 809 667 RCS Créteil
www.valeo.com

1-2. Opening, closing and locking the doors

1

Before driving

Česky [Czech]	Valeo Comfort and Driving Assistance tímto prohlašuje, že tento 0603B1-A je ve shodě se základními požadavky a dalšími příslušnými ustanoveními směrnice 1999/5/ES.
Hrvatski [Croatian]	Ovime, Valeo Comfort and Driving Assistance izjavljuje da je model 0603B1-A je u skladu sa osnovnim zahtjevima i drugim relevantnim odredbama Direktive 1999/5/EC.
Dansk [Danish]	Undertegnede Valeo Sécurité Habitacle erklærer herved, at følgende udstyr 0603B1-A overholder de væsentlige krav og øvrige relevante krav i direktiv 1999/5/EF.
Deutsch [German]	Hiermit erkläre Valeo Sécurité Habitacle, dass sich das Model 0603B1-A in Übereinstimmung mit den grundlegenden Anforderungen und den übrigen einschlägigen Bestimmungen der Richtlinie 1999/5/EG befindet.
Eesti [Estonian]	Käesolevaga kinnitab Valeo Sécurité Habitacle seadme 0603B1-A vastavust direktiivi 1999/5/EÜ põhinõuetele ja nimetatud direktiivist tulenevatele teistele asjakohastele sätetele.
English	Hereby, Valeo Sécurité Habitacle declares that the model 0603B1-A is in compliance with the essential requirements and other relevant provisions of Directive 1999/5/EC.
Español [Spanish]	Por medio de la presente Valeo Sécurité Habitacle declara que 0603B1-A cumple con los requisitos esenciales y cualesquiera otras disposiciones aplicables o exigibles de la Directiva 1999/5/CE.
Ελληνική [Greek]	Με την παρούσα Valeo Sécurité Habitacle δηλώνει ότι 0603B1-A συμμορφώνεται προς τω ουσιώδεις απαιτήσεις και τω λοιπών σχετικών διατάξεων τω οδηγίου 1999/5/ΕΚ.
Français [French]	Par la présente Valeo Sécurité Habitacle déclare que les appareils modèle 0603B1-A sont conformes aux exigences essentielles et aux autres dispositions pertinentes de la directive 1999/5/CE.
Italiano [Italian]	Con la presente Valeo Sécurité Habitacle dichiara che questo 0603B1-A è conforme ai requisiti essenziali ed alle altre disposizioni pertinenti stabilite dalla direttiva 1999/5/CE.
Latviski [Latvian]	Ar šo Valeo Sécurité Habitacle deklarē, ka 0603B1-A atbilst Direktīvas 1999/5/EK būtiskajām prasībām un citiem ar to saistītajiem noteikumiem.
Lietuvių [Lithuanian]	Šiuo Valeo Sécurité Habitacle deklaruoja, kad šis 0603B1-A atitinka esminius reikalavimus ir kitas 1999/5/EB Direktyvos nuostatas.
Nederlands [Dutch]	Hierbij verklaart Valeo Sécurité Habitacle dat het toestel 0603B1-A in overeenstemming is met de essentiële eisen en de andere relevante bepalingen van richtlijn 1999/5/EG.

1-2. Opening, closing and locking the doors

Malti [Maltese]	Hawnhekk, Valeo Sécurité Habitacle, jiddikjara li dan O603B1-A jikkonforma mal-ftigijiet essenzjali u ma provvedimenti oħrajn relevanti li hemm fid-Direttiva 1999/5/EC.
Magyar [Hungarian]	Alulírott, Valeo Sécurité Habitacle nyilatkozom, hogy a O603B1-A megfelel a vonatkozó alapvető követelményeknek és az 1999/5/EC irányelv egyéb előírásainak.
Polski [Polish]	Niniejszym Valeo Sécurité Habitacle oświadcza, że O603B1-A jest zgodny z zasadniczymi wymogami oraz pozostałymi stosownymi postanowieniami Dyrektywy 1999/5/EC.
Português [Portuguese]	Valeo Sécurité Habitacle declara que este O603B1-A está conforme com os requisitos essenciais e outras disposições da Directiva 1999/5/CE.
Slovensko [Slovenian]	Valeo Sécurité Habitacle izjavlja, da je ta O603B1-A v skladu z bistvenimi zahtevami in ostalimi relevantnimi določili direktive 1999/5/ES.
Slovensky [Slovak]	Valeo Sécurité Habitacle týmto vyhlasuje, že O603B1-A spĺňa základné požiadavky a všetky príslušné ustanovenia Smernice 1999/5/ES.
Suomi [Finnish]	Valeo Sécurité Habitacle vakuuttaa täten että O603B1-A tyyppinen laite on direktiivin 1999/5/EY oleellisten vaatimusten ja sitä koskevien direktiivin muiden ehtojen mukainen.
Svenska [Swedish]	Härmed intygar Valeo Sécurité Habitacle att denna O603B1-A står i överensstämmelse med de väsentliga egenskapskrav och övriga relevanta bestämmelser som framgår av direktiv 1999/5/EG.
Íslenska [Icelandic]	Hér með lýsir Valeo Sécurité Habitacle yfir því að O603B1-A er í samræmi við grunnkröfur og aðrar kröfur, sem gerðar eru í tilskipun 1999/5/EC.
Norsk [Norwegian]	Valeo Sécurité Habitacle erklærer herved at utstyret O603B1-A er i samsvar med de grunnleggende krav og øvrige relevante krav i direktiv 1999/5/EF.
Crnogorski jezik [Montenegrin]	Ovime, Valeo Comfort and Driving Assistance izjavljuje da je model O603B1-A je u skladu sa osnovnim zahtjevima i drugim relevantnim odredbama Direktive 1999/5/EC.
српски [Serbian]	Овиме, Valeo Comfort and Driving Assistance изјављује да је О603В1-А модел је у складу са основним захтевима и другим релевантним одредбама Директиве 1999/5/ЕУ.

1-2. Opening, closing and locking the doors

Side doors

The vehicle can be locked and unlocked using the smart entry & start system, wireless remote control, key or door lock switch.

■ Smart entry & start system (if equipped)

→P. 42

■ Wireless remote control

→P. 64

■ Key (driver's door only)

Turning the key operates the doors as follows:

► Vehicles without smart entry & start system

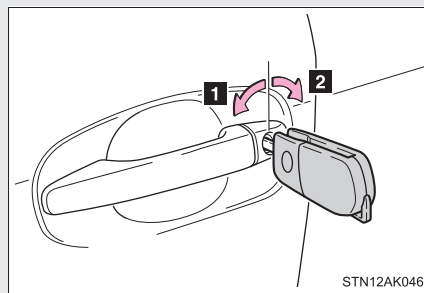

1 Locks all doors

2 Unlocks all doors

► Vehicles with smart entry & start system

The doors can also be locked and unlocked with the mechanical key. (→P. 562)

■ Door lock switch

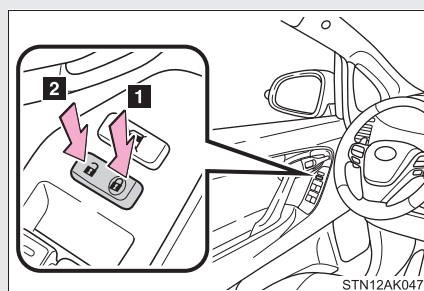

1 Locks all doors

2 Unlocks all doors

1

Before driving

1-2. Opening, closing and locking the doors

■ Inside door lock buttons

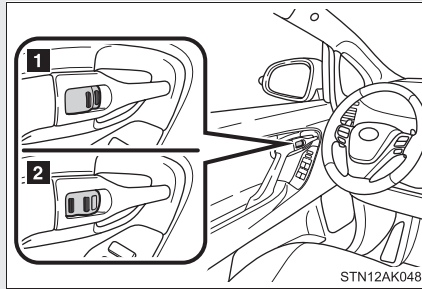

1 Locks the door

2 Unlocks the door

The front doors can be opened by pulling the inside handle even if the inside door lock button is in the lock position.

Locking the driver's door from the outside without a key

STEP 1 Move the inside door lock button to the lock position.

STEP 2 Close the door while pulling the door handle.

► Vehicles without smart entry & start system

The door cannot be locked if the key is in the engine switch.

► Vehicles with smart entry & start system

The door cannot be locked if the "ENGINE START STOP" switch is in the ACCESSORY or IGNITION ON mode, or the electronic key is left inside the vehicle.

The key may not be detected correctly and the door may be locked.

Rear door child-protector lock

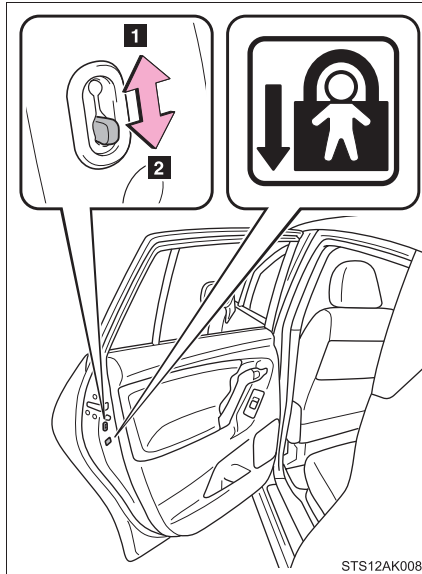

The door cannot be opened from inside the vehicle when the lock is set.

- 1** Unlock
- 2** Lock

These locks can be set to prevent children from opening the rear doors. Push down the each rear door switch to lock both rear doors.

1

Before driving

Automatic door locking and unlocking systems

The following functions can be set or canceled:

Function	Operation
Shift position linked door locking function *1	Shifting the shift lever out of "P" locks all doors.
Shift position linked door unlocking function *1	Shifting the shift lever to "P" unlocks all doors.
Speed linked door locking function *2	All doors are locked when the vehicle speed is approximately 20 km/h (12 mph) or higher.
Driver's door linked door unlocking function *2	<ul style="list-style-type: none"> ▶ Vehicles without smart entry & start system All doors are unlocked when the driver's door is opened within approximately 45 seconds after turning the engine switch to the "LOCK" position. ▶ Vehicles with smart entry & start system All doors are unlocked when the driver's door is opened within approximately 45 seconds after turning the "ENGINE START STOP" switch off.

*1: Vehicles with a Multidrive

*2: Default setting

■ **Setting and canceling the functions**

► Vehicles without Navigation/Multimedia system

To switch between setting and canceling, follow the procedure below:

STEP 1 Vehicles without smart entry & start system: Close all the doors and turn the engine switch to the “ON” position. (Perform **STEP 2** within 10 seconds.)

Vehicles with smart entry & start system: Close all the doors and turn the “ENGINE START STOP” switch to IGNITION ON mode. (Perform **STEP 2** within 10 seconds.)

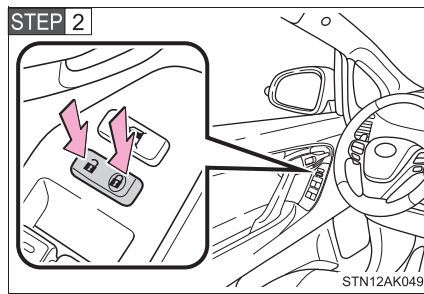

Shift the shift lever to “P” or “N”, press and hold the door lock switch (🔒 or 🔓) for about 5 seconds then release.

The shift lever and switch positions corresponding to the desired function to be set are shown as follows.

Use the same procedure to cancel the function.

Function	Shift lever position	Door lock switch position
Shift position linked door locking function*	“P”	🔒
Shift position linked door unlocking function*		🔓
Speed linked door locking function	“N”	🔒
Driver’s door linked door unlocking function		🔓

*: Vehicles with a Multidrive

1-2. Opening, closing and locking the doors

When the setting or canceling operation is complete, all doors are locked and then unlocked.

► Vehicles with Navigation/Multimedia system

→P. 602

■ **Impact detection door lock release system**

In the event that the vehicle is subject to a strong impact, all the doors are unlocked. Depending on the force of the impact or the type of accident, however, the system may not operate.

■ **Using the mechanical key (vehicles with smart entry & start system)**

The doors can also be locked and unlocked with the mechanical key.
(→P. 562)

■ **If a wrong key is used (vehicles with alarm)**

The key cylinder rotates freely to inside mechanism.

 **CAUTION**

■ **To prevent an accident**

Observe the following precautions while driving the vehicle.
Failing to do so may result in a door opening and an occupant falling out, resulting in death or serious injury.

- Always use a seat belt.
- Ensure that all doors are properly closed.
- Do not pull the inside handle of the doors while driving.
The doors may be opened and the passengers are thrown out of the vehicle and it may result in serious injury or death.
Be especially careful for the front doors, as the doors may be opened even if the inside door lock buttons are in locked position.
- Set the rear door child-protector locks when children are seated in the rear seat.

1-2. Opening, closing and locking the doors

Back door

The back door can be locked/unlocked and opened by the following procedures.

■ Locking and unlocking the back door

- ▶ Smart entry & start system (if equipped)
→P. 42
- ▶ Wireless remote control
→P. 64
- ▶ Key
→P. 73
- ▶ Door lock switch
→P. 73

■ Opening the back door from outside the vehicle

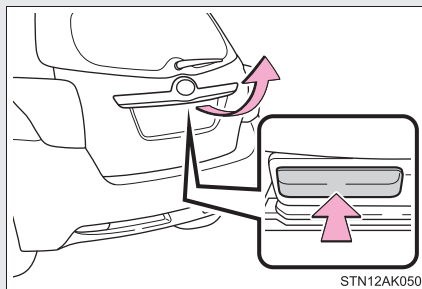

Raise the back door while pushing up the back door opener switch.

1

Before driving

1-2. Opening, closing and locking the doors

When closing the back door

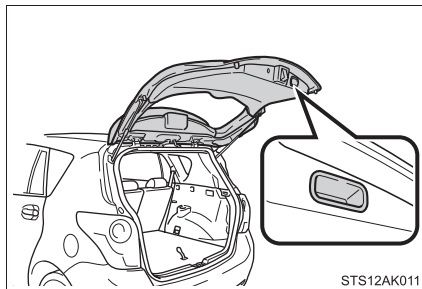

Lower the back door using the back door handle, and make sure to push the back door down from the outside to close it.

■ Luggage compartment light

The luggage compartment light turns on when the back door is opened with the luggage compartment light switch on.

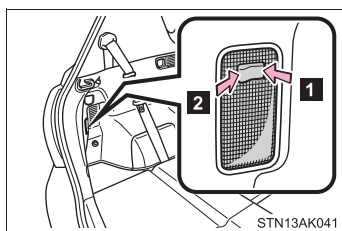

1 On

2 Off

■ If the back door opener is inoperative or the battery is discharged

→P. 561

 CAUTION

■ **Caution while driving**

- Keep the back door closed while driving.
If the back door is left open, it may hit near-by objects while driving or luggage may be unexpectedly thrown out, causing an accident.
In addition, exhaust gases may enter the vehicle, causing death or a serious health hazard. Make sure to close the back door before driving.
- Before driving the vehicle, make sure that the back door is fully closed. If the back door is not fully closed, it may open unexpectedly while driving, causing an accident.
- Never let anyone sit in the luggage compartment. In the event of sudden braking or a collision, they are susceptible to death or serious injury.

■ **When children are in the vehicle**

Observe the following precautions.

Failure to do so may result in death or serious injury.

- Do not allow children to play in the luggage compartment.
If a child is accidentally locked in the luggage compartment, they could have heat exhaustion or other injuries.
- Do not allow a child to open or close the back door.
Doing so may cause the back door to move unexpectedly, or cause the child's hands, head, or neck to be caught by the closing back door.

■ **Operating the back door**

Observe the following precautions.

Failure to do so may cause parts of the body to be caught, resulting in death or serious injury.

- Remove any heavy loads, such as snow and ice, from the back door before opening it. Failure to do so may cause the back door to suddenly shut again after it is opened.
- When opening or closing the back door, thoroughly check to make sure the surrounding area is safe.
- If anyone is in the vicinity, make sure they are safe and let them know that the back door is about to open or close.
- Use caution when opening or closing the back door in windy weather as it may move abruptly in strong wind.

⚠ CAUTION

■ Operating the back door

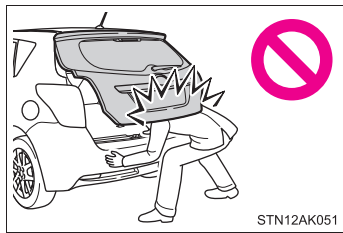

- The back door may suddenly shut if it is not opened fully. It is more difficult to open or close the back door on an incline than on a level surface, so beware of the back door unexpectedly opening or closing by itself. Make sure that the back door is fully open and secure before using the luggage compartment.

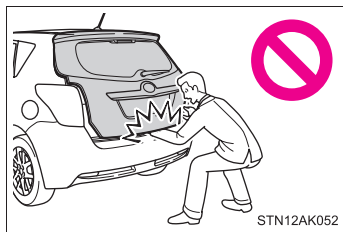

- When closing the back door, take extra care to prevent your fingers etc. from being caught.
- When closing the back door, make sure to press it lightly on its outer surface. If the back door handle is used to fully close the back door, it may result in hands or arms being caught.

- Do not pull on the back door damper stay to close the back door, and do not hang on the back door damper stay. Doing so may cause hands to be caught or the back door damper stay to break, causing an accident.
- If a bicycle carrier or similar heavy object is attached to the back door, it may suddenly shut again after being opened, causing someone's hands, head or neck to be caught and injured. When installing an accessory part to the back door, using a genuine Toyota part is recommended.

 NOTICE

■ **Back door damper stays**

The back door is equipped with damper stays that hold the back door in place.

Observe the following precautions.

Failure to do so may cause damage to the back door damper stay, resulting in malfunction.

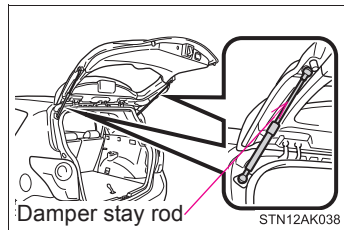

- Do not attach any foreign objects, such as stickers, plastic sheets, or adhesives to the damper stay rod.
- Do not touch the damper stay rod with gloves or other fabric items.
- Do not attach any accessories other than genuine Toyota parts to the back door.
- Do not place your hand on the damper stay or apply lateral forces to it.

1-3. Adjustable components (seats, mirrors, steering wheel) Front seats

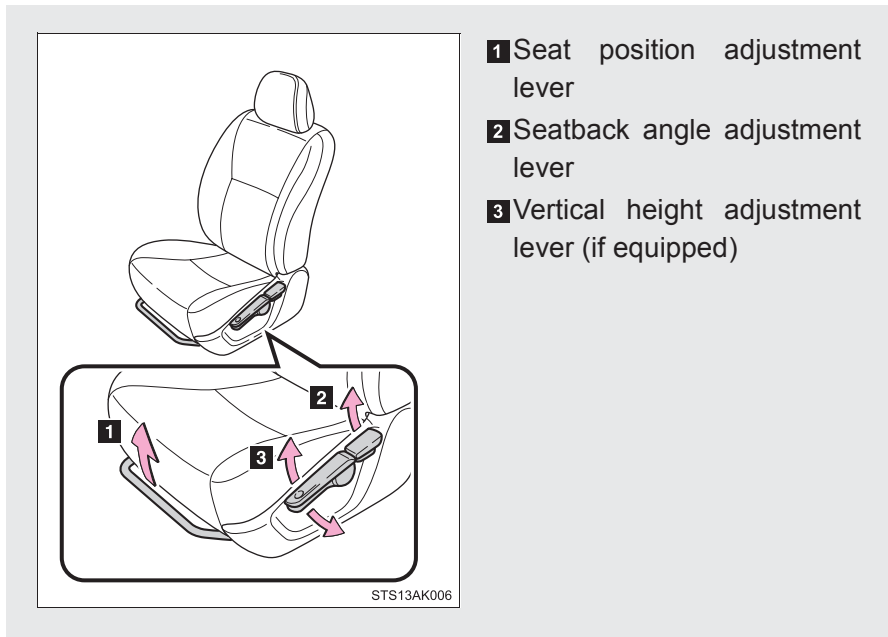

Active head restraints

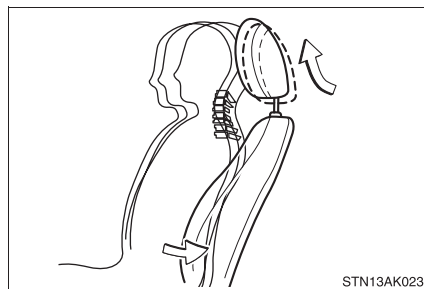

When the occupant's lower back presses against the seatback during a rear-end collision, the head restraint moves slightly forward and upward to help reduce the risk of whiplash on the seat occupant.

■ **Active head restraints**

Even small forces applied to the seatback may cause the head restraint to move. Pushing up a locked head restraint forcibly may show the head restraint inner structure. These do not indicate problems.

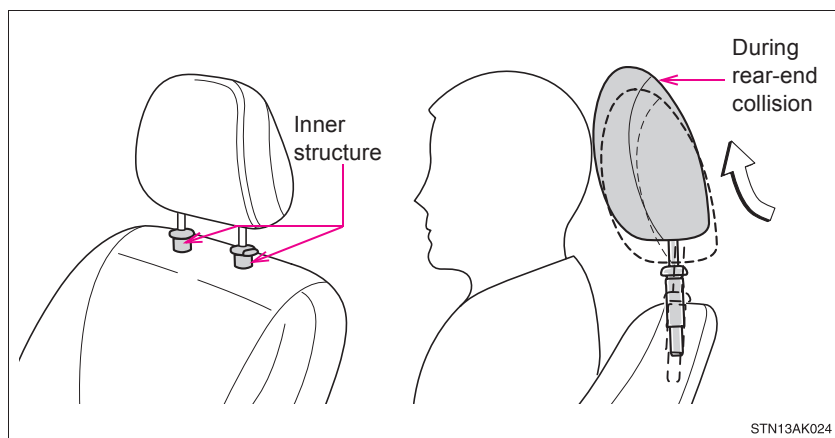

1

Before driving

⚠ CAUTION

■ **Seat adjustment**

- Be careful that the seat does not hit passengers or luggage.
- To reduce the risk of sliding under the lap belt during a collision, do not recline the seat more than necessary.
If the seat is too reclined, the lap belt may slide past the hips and apply restraint forces directly to the abdomen or your neck may contact the shoulder belt, increasing the risk of death or serious injury in the event of an accident.
Adjustments should not be made while driving as the seat may unexpectedly move and cause the driver to lose control of the vehicle.
- After adjusting the seat, make sure that the seat is locked in position.

1-3. Adjustable components (seats, mirrors, steering wheel) Rear seats*

■ Adjusting the second seats

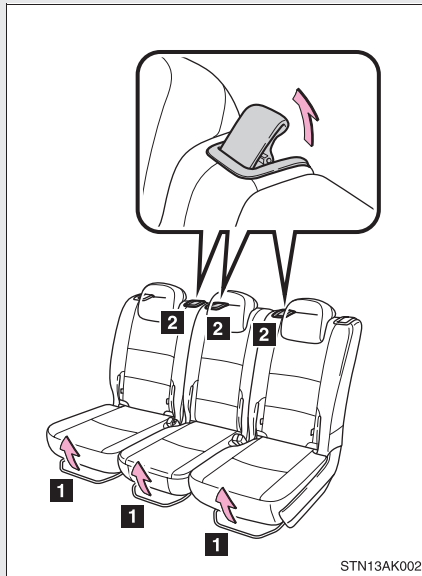

- 1** Seat position adjustment lever
- 2** Seatback angle adjustment lever

STN13AK002

*: If equipped

1-3. Adjustable components (seats, mirrors, steering wheel)

■ Adjusting the third seats (if equipped)

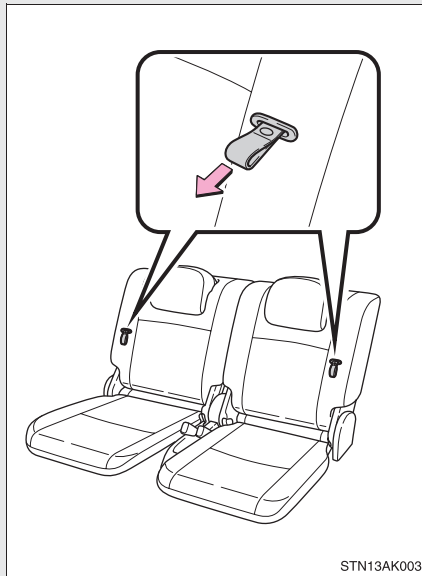

Seatback angle adjustment strap

STN13AK003

1

Before driving

Moving a second seat for third seat access (vehicles with third seats)

■ Getting in the vehicle

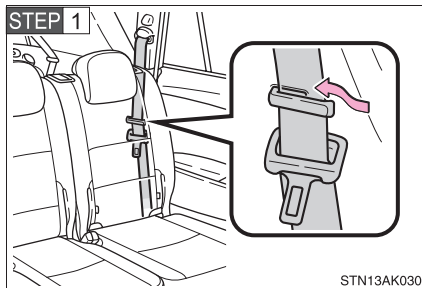

Pass the outside seat belt through the seat belt hanger.

This prevents the shoulder belt from being damaged.

STN13AK030

1-3. Adjustable components (seats, mirrors, steering wheel)

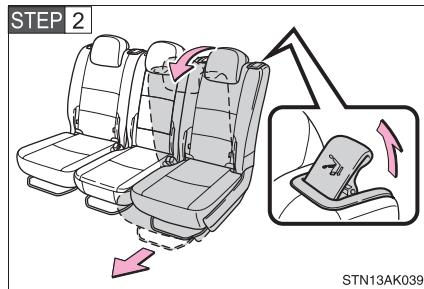

Pull up the walk-in lever and fold down the seatback. The seat will slide forward.

Move the seat to the front-most position.

■ Getting out of the vehicle

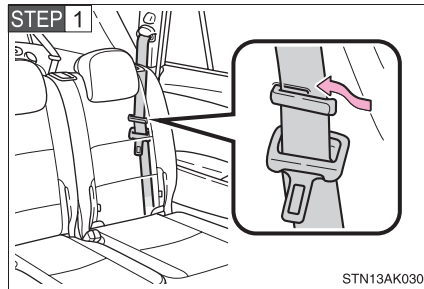

Pass the outside seat belt through the seat belt hanger.

This prevents the shoulder belt from being damaged.

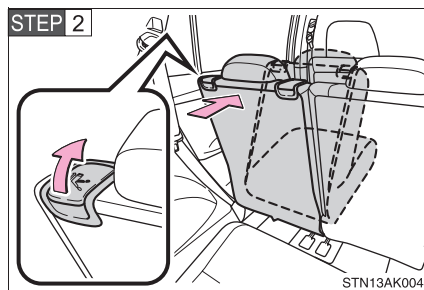

Pull up the walk-in lever and fold down the seatback. The seat will slide forward.

Move the seat to the front-most position.

Make sure that no passenger is seated on the second seat before operating the walk-in lever.

■ After passengers have entered/exited the vehicle

STEP 1 Lift up the seatback and slide the seat backward until it locks.

STEP 2 Remove the outside seat belt from the seat belt hanger.

Folding down the second seats (vehicles with second seats)

■ **Before folding down the second seats**

STEP 1 Stow the second center seat belt. (→P. 98)

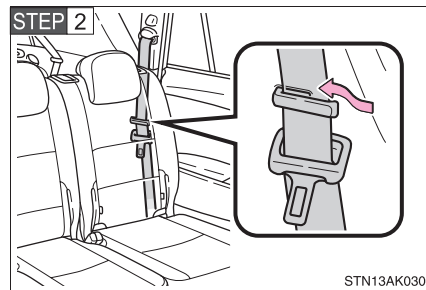

Pass the outside seat belts through the seat belt hangers.

This prevents the shoulder belt from being damaged.

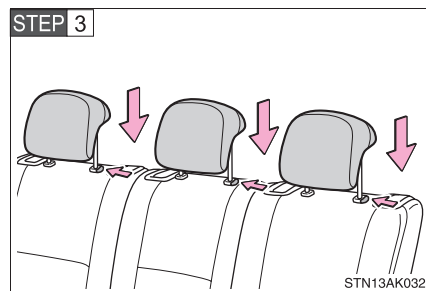

Adjust the head restraint to the down-most position.

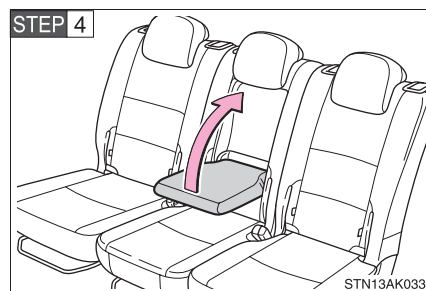

Raise the armrest.

1
Before driving

1-3. Adjustable components (seats, mirrors, steering wheel)

■ Folding down the second seats

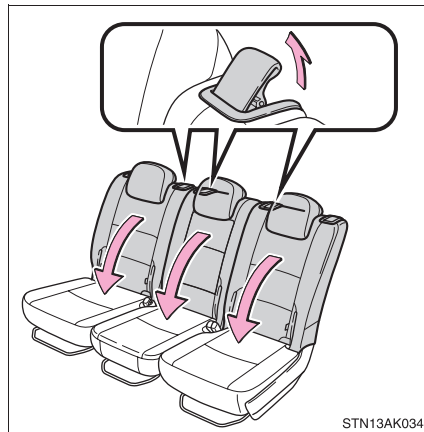

Pull up the seatback angle adjustment lever and fold down the seatback.

■ Returning the second seats

STEP 1 Lift up the seatbacks until they lock.

STEP 2 Remove the outside seat belts from the seat belt hangers.

STEP 3 Replace the second center seat belt. (→P. 98)

Folding down the third seats (vehicles with third seats)

■ Before folding down the third seats

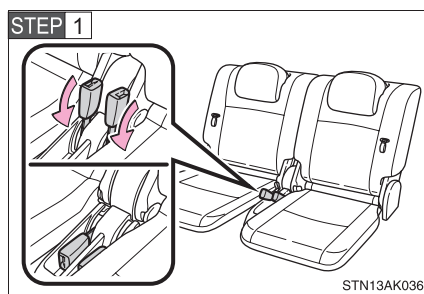

Stow the seat belt buckles as shown.

1-3. Adjustable components (seats, mirrors, steering wheel)

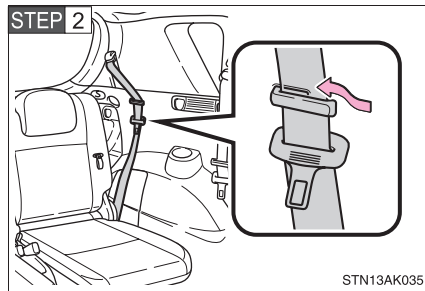

Pass the outside seat belts through the seat belt hangers.

This prevents the shoulder belt from being damaged.

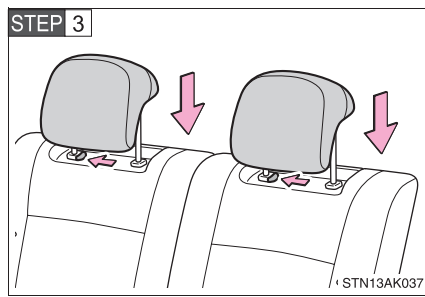

Adjust the head restraint to the down-most position.

■ **Folding down the third seats**

► From inside

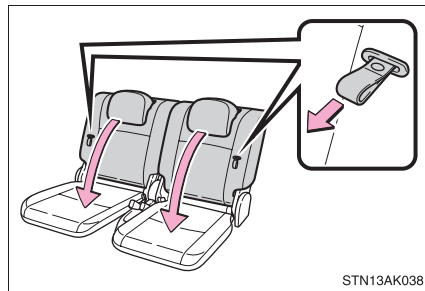

Pull the seatback angle adjustment strap and fold down the seatback.

1

Before driving

1-3. Adjustable components (seats, mirrors, steering wheel)

► From outside

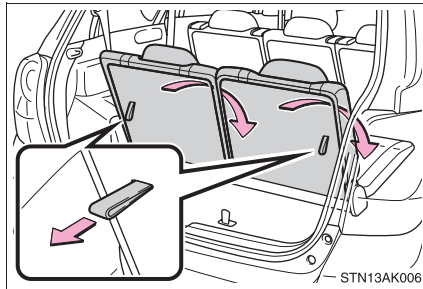

Open the back door and pull the lock release strap to fold down the third seats.

■ Returning the third seats

STEP 1 Lift up the seatbacks until they lock.

STEP 2 Remove the outside seat belts from the seat belt hangers.

⚠ CAUTION

■ When folding the rear seatbacks down

Observe the following precautions. Failure to do so may result in death or serious injury.

- Do not fold the seatbacks down while driving.
- Stop the vehicle on level ground, set the parking brake and shift the shift lever to "P" (Multidrive) or "1" (manual transmission).
- Do not allow anyone to sit on a folded seatback or in the luggage compartment while driving.
- Do not allow children to enter the luggage compartment.

 CAUTION

■ **Seat adjustment**

- Be careful not to get your hands pinched between the luggage cover and the seat.
- To reduce the risk of sliding under the lap belt during a collision, do not recline the seat more than necessary. If the seat is too reclined, the lap belt may slide past the hips and apply restraint forces directly to the abdomen, or your neck may contact the shoulder belt, increasing the risk of death or serious injury in the event of an accident. Adjustments should not be made while driving as the seat may unexpectedly move and cause the driver to lose control of the vehicle.

■ **After returning the seatbacks to the upright position**

Observe the following precautions. Failure to do so may result in death or serious injury.

- Make sure the seatback is securely locked by pressing forward and rearward on the top.
- Check that the seat belts are not twisted or caught in the seatback.

 NOTICE

■ **Stowing the seat belts**

The seat belts and the buckles must be stowed before you fold down the rear seatbacks.

1-3. Adjustable components (seats, mirrors, steering wheel) Head restraints

► Front seats

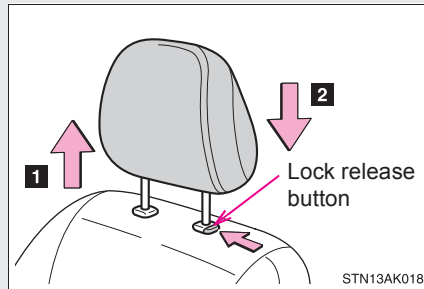

Vertical adjustment

1 Up

Pull the head restraints up.

2 Down

Push the head restraint down while pushing the lock release button.

► Second seats (if equipped)

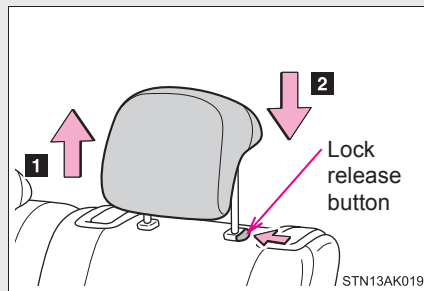

Vertical adjustment

1 Up

Pull the head restraints up.

2 Down

Push the head restraint down while pushing the lock release button.

► Third seats (if equipped)

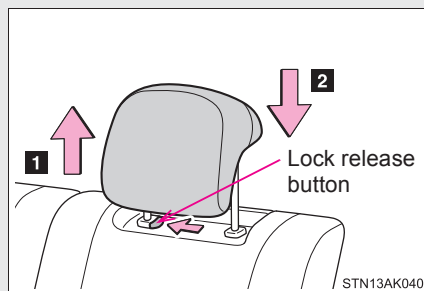

Vertical adjustment

1 Up

Pull the head restraints up.

2 Down

Push the head restraint down while pushing the lock release button.

■ **Removing the head restraints**

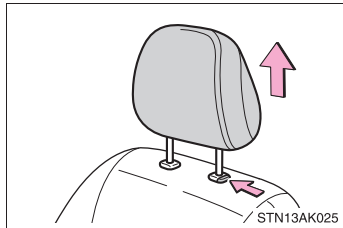

Pull the head restraint up while pressing the lock release button.

■ **Adjusting the height of the head restraints**

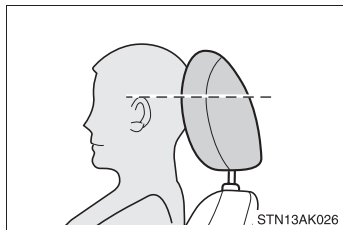

Make sure that the head restraints are adjusted so that the center of the head restraint is closest to the top of your ears.

■ **Adjusting the rear seat head restraint (vehicles with rear seats)**

Always raise the head restraint one level from the stowed position when using.

⚠ CAUTION

■ **Head restraint precautions**

Observe the following precautions regarding the head restraints. Failure to do so may result in death or serious injury.

- Use the head restraints designed for each respective seat.
- Adjust the head restraints to the correct position at all times.
- After adjusting the head restraints, push down on them and make sure they are locked in position.
- Do not drive with the head restraints removed.

1-3. Adjustable components (seats, mirrors, steering wheel)

Seat belts

Make sure that all occupants are wearing their seat belts before driving the vehicle.

■ Correct use of the seat belts

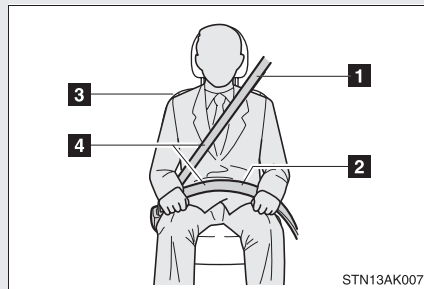

- 1 Extend the shoulder belt so that it comes fully over the shoulder, but does not come into contact with the neck or slide off the shoulder.
- 2 Position the lap belt as low as possible over the hips.
- 3 Adjust the position of the seatback. Sit up straight and well back in the seat.
- 4 Do not twist the seat belt.

■ Fastening and releasing the seat belt

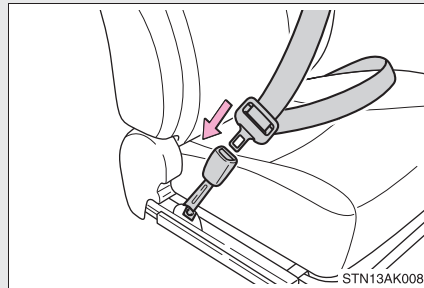

Fastening the belt

Push the plate into the buckle until a click sound is heard.

1-3. Adjustable components (seats, mirrors, steering wheel)

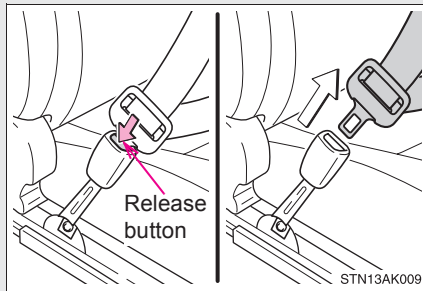

Releasing the belt

Press the release button.

■ Adjusting the seat belt shoulder anchor height (front seats)

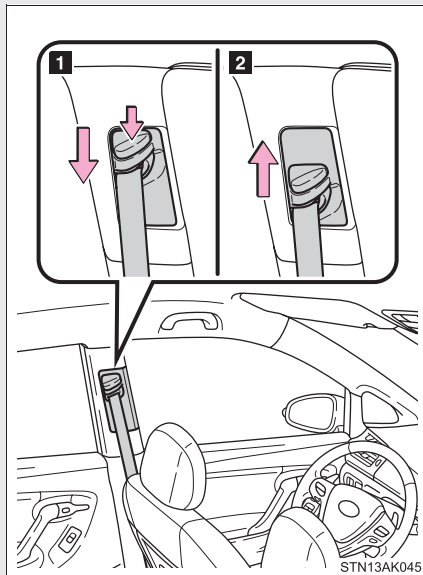

1 Push the seat belt shoulder anchor down while pressing the release button.

2 Push the seat belt shoulder anchor up.

Move the height adjuster up and down as needed until you hear a click.

1

Before driving

Center second seat belt (if equipped)

The center second seat belt is a 3-point type restraint with 2 buckles. Both seat belt buckles must be correctly located and securely latched for proper operation.

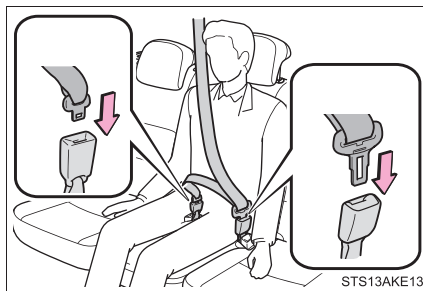

Fastening the belt

Push each of the plates into the buckles until a click sound is heard.

■ Release method

The center second seat belt can be completely released when not required, such as when folding down the second seat.

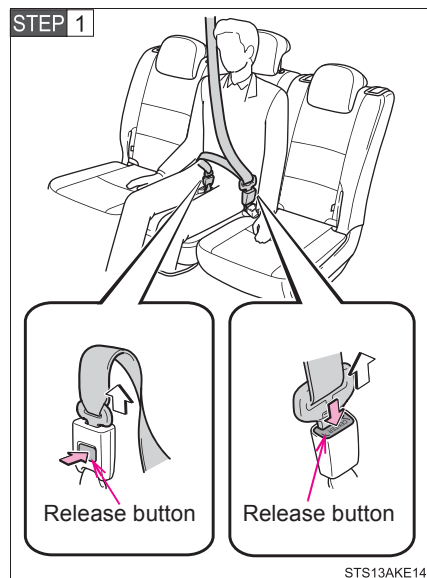

Releasing the belt

Press each of the release buttons.

1-3. Adjustable components (seats, mirrors, steering wheel)

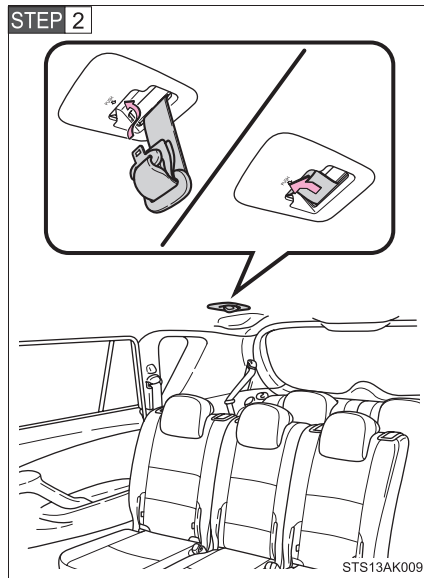

Stow the seat belt tabs in the cover set in the roof as shown.

1

Before driving

■ Extracting the belt

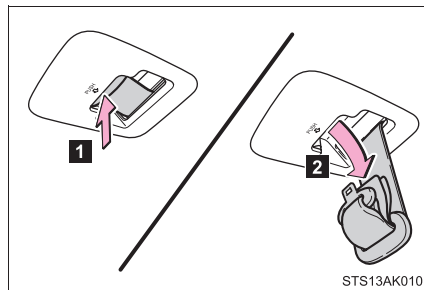

- 1 Push the tab.
- 2 Remove the tabs from the cover.

Seat belt pretensioners (front seats)

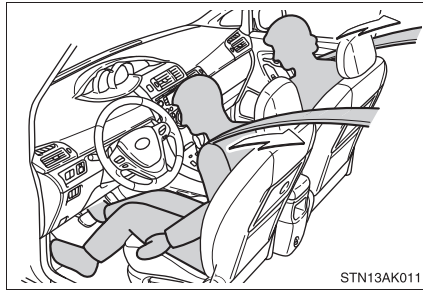

The pretensioner helps the seat belt to quickly restrain the occupant by retracting the seat belt when the vehicle is subjected to certain types of severe frontal collision.

The pretensioner may not activate in the event of a minor frontal impact, a side impact or a rear impact.

■ Emergency locking retractor (ELR)

The retractor will lock the belt during a sudden stop or on impact. It may also lock if you lean forward too quickly. A slow, easy motion will allow the belt to extend so that you can move around fully.

■ Child seat belt usage

The seat belts of your vehicle were principally designed for persons of adult size.

- Use a child restraint system appropriate for the child, until the child becomes large enough to properly wear the vehicle's seat belt. (→P. 158)
- When the child becomes large enough to properly wear the vehicle's seat belt, follow the instructions on P. 96 regarding seat belt usage.

■ Replacing the belt after the pretensioner has been activated

If the vehicle is involved in multiple collisions, the pretensioner will activate for the first collision, but will not activate for the second or subsequent collisions.

■ Seat belt regulations

If seat belt regulations exist in the country where you reside, please contact any authorized Toyota dealer or repairer, or another duly qualified and equipped professional, for seat belt replacement or installation.

⚠ CAUTION

Observe the following precautions to reduce the risk of injury in the event of sudden braking, sudden swerving or an accident. Failing to do so may cause death or serious injury.

■ Wearing a seat belt

- Ensure that all passengers wear a seat belt before driving.
- Always wear a seat belt properly.
- Each seat belt should be used by one person only. Do not use a seat belt for more than one person at once, including children.
- Toyota recommends that children be seated in the rear seat and always use a seat belt and/or an appropriate child restraint system.
- Do not recline the seat any more than necessary to achieve a proper seating position. The seat belt is most effective when the occupants are sitting up straight and well back in the seats.
- Do not wear the shoulder belt under your arm.
- Always wear your seat belt low and snug across your hips.

■ Pregnant women

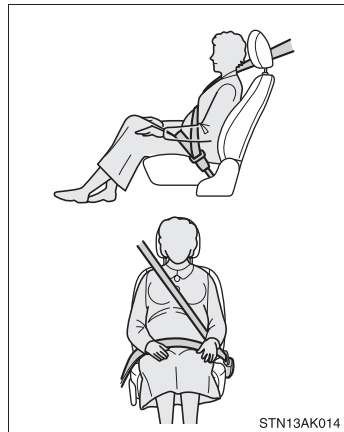

Obtain medical advice and wear the seat belt in the proper way. (→P. 96)

Women who are pregnant should position the lap belt as low as possible over the hips in the same manner as other occupants. Extend the shoulder belt completely over the shoulder and position the belt across the chest. Avoid belt contact over the rounding of the abdominal area.

If the seat belt is not worn properly, not only the pregnant woman, but also the fetus could suffer death or serious injury as a result of sudden braking or a collision.

■ People suffering illness

Obtain medical advice and wear the seat belt in the proper way. (→P. 96)

 CAUTION

■ **When children are in the vehicle**

Do not allow children to play with the seat belt. If the seat belt becomes twisted around a child's neck, it may lead to choking or other serious injuries that could result in death.

If this occurs and the buckle cannot be unfastened, scissors should be used to cut the belt.

■ **Seat belt pretensioners**

If the pretensioner has activated, the SRS warning light will come on. In that case, the seat belt cannot be used again and must be replaced at any authorized Toyota dealer or repairer, or another duly qualified and equipped professional.

■ **Adjustable shoulder anchor**

Always make sure the shoulder belt is positioned across the center of your shoulder. The belt should be kept away from your neck, but not falling off your shoulder. Failure to do so could reduce the amount of protection in an accident and cause death or serious injuries in the event of a sudden stop, sudden swerve or accident. (→P. 97)

■ **Seat belt damage and wear**

- Do not damage the seat belts by allowing the belt, plate, or buckle to be jammed in the door.
- Inspect the seat belt system periodically. Check for cuts, fraying, and loose parts. Do not use a damaged seat belt until it is replaced. Damaged seat belt cannot protect an occupant from death or serious injury.
- Ensure that the belt and plate are locked and the belt is not twisted.
If the seat belt does not function correctly, immediately contact any authorized Toyota dealer or repairer, or another duly qualified and equipped professional.
- Replace the seat assembly, including the belts, if your vehicle has been involved in a serious accident, even if there is no obvious damage.

⚠ CAUTION

■ **Seat belt damage and wear**

- Do not attempt to install, remove, modify, disassemble or dispose of the seat belts. Have any necessary repairs carried out by any authorized Toyota dealer or repairer, or another duly qualified and equipped professional. Inappropriate handling of the pretensioner may prevent it from operating properly resulting in death or serious injury.

■ **When using the center second seat belt**

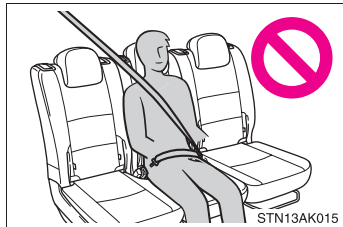

Do not use the center second seat belt with either buckle released. Fastening only one of the buckles may result in death or serious injury in case of sudden braking or a collision.

1-3. Adjustable components (seats, mirrors, steering wheel) Steering wheel

The steering wheel can be adjusted to a comfortable position.

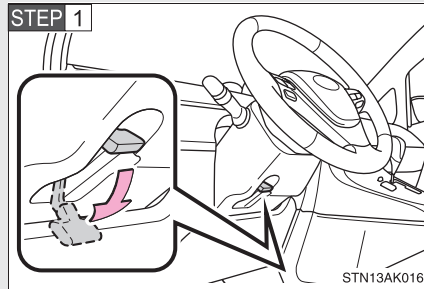

Hold the steering wheel and press the lever down.

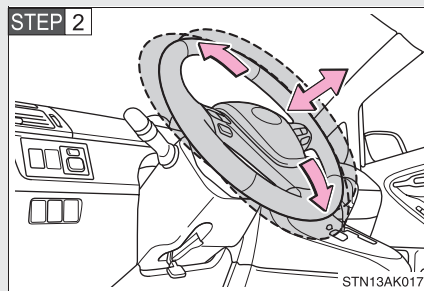

Adjust to the ideal position by moving the steering wheel horizontally and vertically.

After adjustment, pull the lever up to secure the steering wheel.

CAUTION

■ Caution while driving

Do not adjust the steering wheel.

Doing so may cause the driver to mishandle the vehicle and cause an accident, resulting in death or serious injury.

■ After adjusting the steering wheel

Make sure that the steering wheel is securely locked.

Otherwise, the steering wheel may move suddenly, possibly causing an accident, and resulting in death or serious injury.

1-3. Adjustable components (seats, mirrors, steering wheel) Anti-glare inside rear view mirror

The rear view mirror's position can be adjusted to enable sufficient confirmation of the rear view in accordance with the driver's seating posture.

Adjusting the height of rear view mirror (vehicles with auto anti-glare inside rear view mirror)

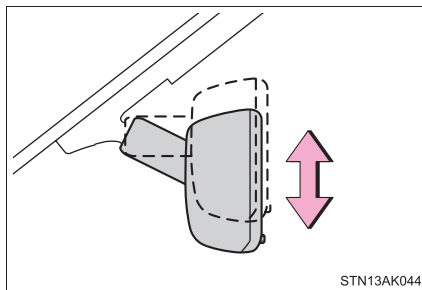

Adjust the height of the rear view mirror by moving it up and down.

1

Before driving

Anti-glare function

► Manual anti-glare inside rear view mirror

Reflected light from the headlights of vehicles behind can be reduced by operating the lever.

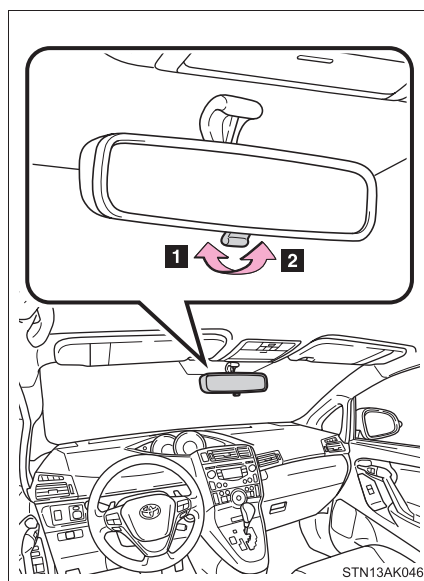

1 Normal position

2 Anti-glare position

► Auto anti-glare inside rear view mirror

Responding to the level of brightness of the headlights of vehicles behind, the reflected light is automatically reduced.

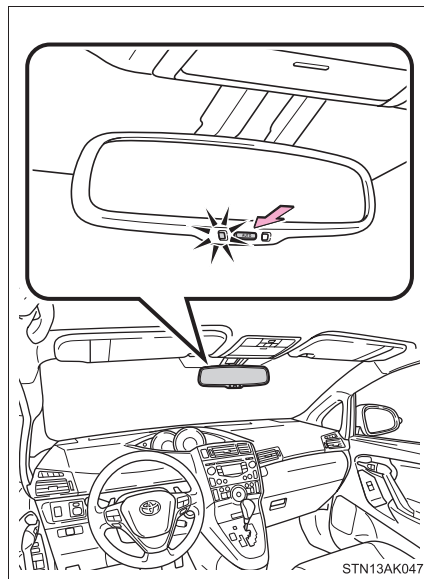

Changing automatic anti-glare function mode ON/OFF

When the automatic anti-glare function is in ON mode, the indicator illuminates.

The function will set to ON mode each time the "ENGINE START STOP" switch is turned to IGNITION ON mode.

Pressing the button turns the function to OFF mode. (The indicator also turns off.)

1

Before driving

■ To prevent sensor error (vehicles with auto anti-glare inside rear view mirror)

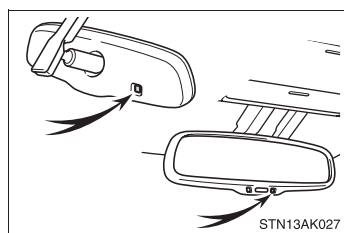

To ensure that the sensors operate properly, do not touch or cover them.

1-3. Adjustable components (seats, mirrors, steering wheel)

CAUTION

■ **Caution while driving**

Do not adjust the position of the mirror while driving.
Doing so may lead to mishandling of the vehicle and cause an accident,
resulting in death or serious injury.

1-3. Adjustable components (seats, mirrors, steering wheel) Outside rear view mirrors

Mirror angle can be adjusted using the switch.

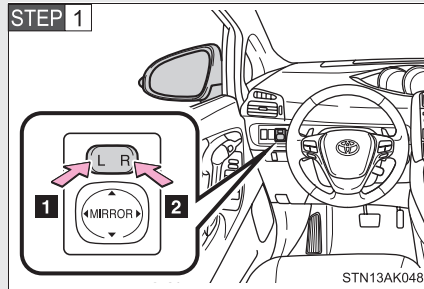

Select a mirror to adjust.

- 1 Left
- 2 Right

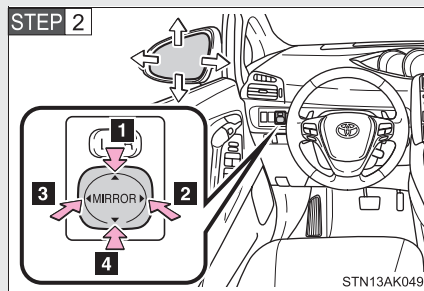

Adjust the mirror.

- 1 Up
- 2 Right
- 3 Left
- 4 Down

1

Before driving

Folding back the mirrors

► Manual operation

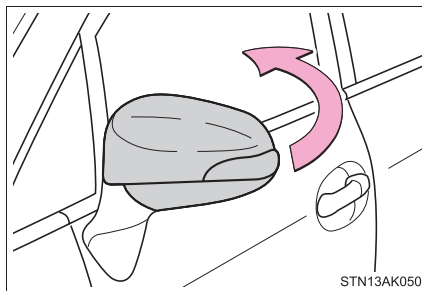

Push backward to fold the mirrors.

1-3. Adjustable components (seats, mirrors, steering wheel)

▶ Electric operation (if equipped)

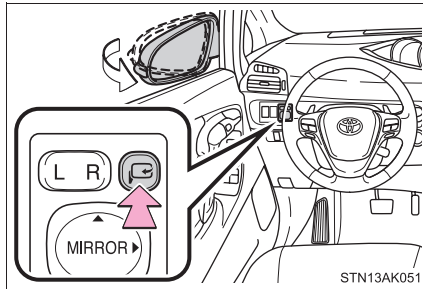

Press the switch to fold the mirrors.

Press it again to extend them to the original position.

■ The outside rear view mirrors can be operated when

▶ Vehicles without smart entry & start system

The engine switch is in the “ACC” or “ON” position.

▶ Vehicles with smart entry & start system

The “ENGINE START STOP” switch is in the ACCESSORY or IGNITION ON mode.

■ When the mirrors are fogged up

The outside rear view mirrors can be cleared using the mirror defoggers. Turn on the rear window defogger to turn on the outside rear view mirror defoggers. (→P. 319)

 CAUTION

■ **Caution while driving**

Observe the following precautions.

Failing to do so may result in loss of control of the vehicle and cause an accident, resulting in death or serious injury.

- Do not adjust the mirrors while driving.
- Do not drive with the mirrors folded back.
- Both the driver and passenger side mirrors must be extended and properly adjusted before driving.

■ **When a mirror is moving**

To avoid personal injury and mirror malfunction, be careful not to get your hand caught by the moving mirror.

■ **When the mirror defoggers are operating**

Do not touch the rear view mirror surfaces, as they can become very hot and burn you.

■ **If ice should jam the mirror**

Do not operate the control or scrape the mirror face. Use a spray de-icer to free the mirror.

1-4. Opening and closing the windows and panoramic roof shade

Power windows

The power windows can be opened and closed using the following switches.

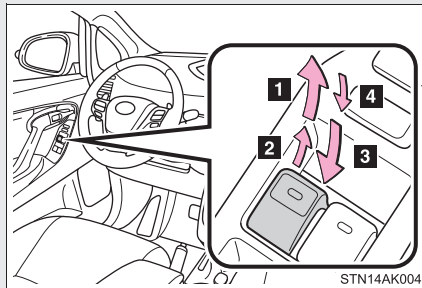

- 1** One-touch closing*^{1, 2}
- 2** Closing
- 3** One-touch opening*^{1, 2}
- 4** Opening

*1: To stop the window partway, operate the switch in the opposite direction.

*2: If equipped on rear windows

Window lock switch

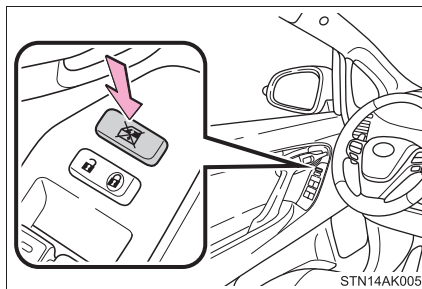

Press the switch down to lock the passenger window switches.

Use this switch to prevent children from accidentally opening or closing a passenger window.

■ **The power windows can be operated when**

▶ Vehicles without smart entry & start system

The engine switch is in the “ON” position.

▶ Vehicles with smart entry & start system

The “ENGINE START STOP” switch is in IGNITION ON mode.

■ **Operating the power windows after turning the engine off**

▶ Vehicles without smart entry & start system

The power windows can be operated for approximately 45 seconds even after the engine switch is turned to the “ACC” or “LOCK” position. They cannot, however, be operated once either front door is opened.

▶ Vehicles with smart entry & start system

The power windows can be operated for approximately 45 seconds even after the “ENGINE START STOP” switch is turned to ACCESSORY mode or turned off. They cannot, however, be operated once either front door is opened.

■ **Jam protection function**

If an object becomes caught between the window and the window frame, window travel is stopped and the window is opened slightly.

■ **When the power window does not close normally**

If the jam protection function is operating abnormally and a window cannot be closed, perform the following operations using the power window switch on the relevant door.

- After stopping the vehicle, the window can be closed by holding the power window switch in the one-touch closing position while the engine switch is turned to the “ON” position (vehicles without smart entry & start system) or the “ENGINE START STOP” switch is turned to IGNITION ON mode (vehicles with smart entry & start system).

1-4. Opening and closing the windows and panoramic roof shade

- If the window still cannot be closed even by carrying out the operation explained above, initialize the function by performing the following procedure.

STEP 1 Hold the power window switch in the one-touch closing position. Continue holding the switch for a further 6 seconds after the window has closed.

STEP 2 Hold the power window switch in the one-touch opening position. Continue holding the switch for a further 2 seconds after the window has opened completely.

STEP 3 Hold the power window switch in the one-touch closing position once again. Continue holding the switch for a further 2 seconds after the window has closed.

If you release the switch while the window is moving, start again from the beginning. If the window continues to close but then re-open slightly even after performing the above procedure correctly, have the vehicle inspected by any authorized Toyota dealer or repairer, or another duly qualified and equipped professional.

 CAUTION

■ **When closing the windows**

Observe the following precautions.

Failing to do so may result in death or serious injury.

- The driver is responsible for all the power window operations, including the operation for the passengers. In order to prevent accidental operation, especially by a child, do not let a child operate the power windows. It is possible for children and other passengers to have body parts caught in the power window. Also, when riding with a child, it is recommended to use the window lock switch. (→P. 112)
- Check to make sure that all passengers do not have any part of their body in a position where it could be caught when a window is being operated.
- When exiting the vehicle, turn the engine switch to the “LOCK” position (vehicles without smart entry & start system) or the “ENGINE START STOP” switch off (vehicles with smart entry & start system), carry the key and exit the vehicle along with the child. There may be accidental operation, due to mischief, etc., that may possibly lead to an accident.

■ **Jam protection function**

- Never use any part of your body to intentionally activate the jam protection function.
- The jam protection function may not work if something gets caught just before the window fully closes.

1-4. Opening and closing the windows and panoramic roof shade Panoramic roof shade*

The panoramic roof shade can be opened and closed by operating the panoramic roof shade switch.

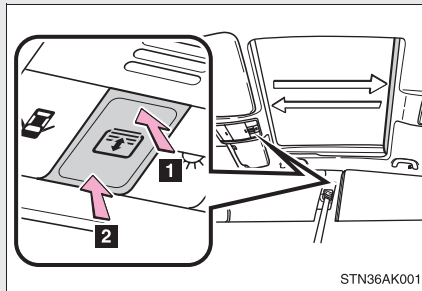

1 Open

To stop partway, press the switch lightly.

2 Close

To stop partway, press the switch lightly.

■ The panoramic roof shade can be operated when

▶ Vehicles without smart entry & start system

The engine switch is in the "ON" position.

▶ Vehicles with smart entry & start system

The "ENGINE START STOP" switch is in IGNITION ON mode.

■ Jam protection function

If an object is detected between the panoramic roof shade and the frame while closing, travel is stopped and the panoramic roof shade opens slightly.

■ If the panoramic roof shade cannot be closed automatically

Keep the switch depressed.

*: If equipped

 CAUTION

■ **When closing the panoramic roof shade**

Observe the following precautions.

Failing to do so may result in death or serious injury.

- Check to make sure that all passengers do not have any part of their bodies in a position where they could be caught when the panoramic roof shade is being operated.
- Do not allow children to operate the panoramic roof shade.
Closing the panoramic roof shade on someone can cause death or serious injury. The driver is responsible for instructing children not to operate the panoramic roof shade.

■ **Jam protection function**

- Never try jamming any part of your body to activate the jam protection function intentionally.
- The jam protection function may not work if something gets caught just before the panoramic roof shade fully closes.

■ **To prevent burns or injury**

Observe the following precautions.

- Although the jam protection function has been installed, make sure that passenger's hands and faces are not caught in the panoramic roof shade while it is closing. Also, as there is a chance that the jam protection function will not react just before closing, make sure not to catch fingers etc. in the roof.
- The opening or closing of the panoramic roof shade can be stopped by pressing the switch.
- If the panoramic roof shade will not close (for example, due to a malfunction in the jam protection function), the shade can be closed by pressing and holding the switch.

1-4. Opening and closing the windows and panoramic roof shade

CAUTION

■ To prevent burns or injury

- The jam protection function may operate if a load or impact, similar to that applied when a foreign object is caught in the roof shade, is applied by environmental or driving conditions.
- The underside of the roof will become hot if the vehicle is left in the direct sunlight for a long period of time. Do not touch the parts inside the gap between the roof underside and the roof shade, as you may burn yourself.
- Do not touch any rough or sheared parts of the roof underside, as you may injure yourself.

NOTICE

■ To prevent battery discharge

Do not operate the panoramic roof shade when the engine is not running.

■ To ensure normal operation of the panoramic roof shade

Observe the following precautions:

- Do not place excessive load on the motor or other components.
- Do not place objects where they may hinder opening and closing operations.
- Do not attach items to the panoramic roof shade.
- Keep the opening clean and clear of obstructions.
- Do not operate the panoramic roof shade continuously for long periods of time.

1-5. Refueling

Opening the fuel tank cap

Perform the following steps to open the fuel tank cap.

■ Before refueling the vehicle

▶ Vehicles without smart entry & start system

- Turn the engine switch off and ensure that all the doors and windows are closed.
- Confirm the type of fuel. (→P. 121)

▶ Vehicles with smart entry & start system

- Turn the “ENGINE START STOP” switch off and ensure that all the doors and windows are closed.
- Confirm the type of fuel. (→P. 121)

■ Opening the fuel tank cap

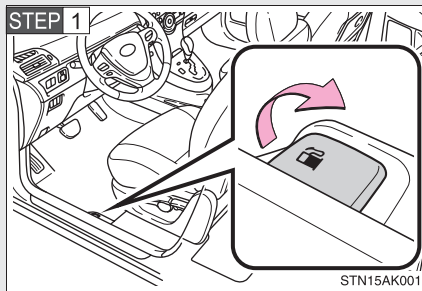

Pull up the fuel filler door opener.

1

Before driving

1-5. Refueling

STEP 2

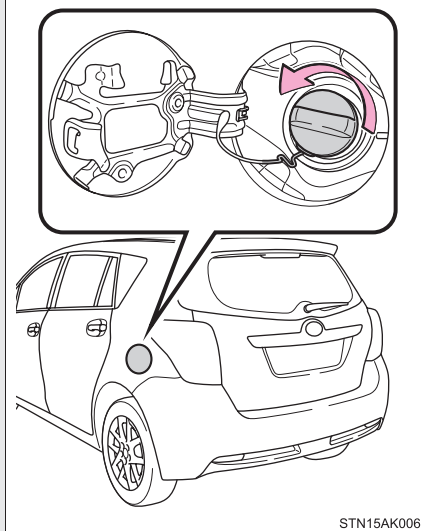

Turn the fuel tank cap slowly to open it.

STEP 3

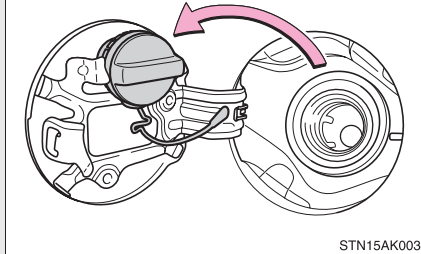

Hang the fuel tank cap on the back of the fuel filler door.

Closing the fuel tank cap

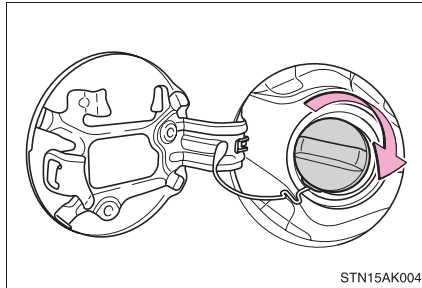

When installing the fuel tank cap, turn it until you hear a click.

The cap will turn slightly to the opposite direction when released.

1

Before driving

■ Fuel types

▶ Gasoline engine

EU area:

Unleaded gasoline conforming to European standard EN228, Research Octane Number of 95 or higher

Except EU area:

Unleaded gasoline, Research Octane Number of 95 or higher

▶ Diesel engine

Diesel fuel conforming to European standard EN590 is an ultra low sulphur diesel (max 10 ppm).

■ Use of ethanol blended gasoline in a gasoline engine

Toyota allows the use of ethanol blended gasoline where the ethanol content is up to 10%. Make sure that the ethanol blended gasoline to be used has a Research Octane Number that follows the above.

 CAUTION

■ **Refueling the vehicle**

Observe the following precautions while refueling the vehicle.
Failure to do so may result in death or serious injury.

- After exiting the vehicle and before opening the fuel door, touch an unpainted metal surface to discharge any static electricity. It is important to discharge static electricity before refueling because sparks resulting from static electricity can cause fuel vapors to ignite while refueling.
- Always hold the grips on the fuel tank cap and turn it slowly to remove it. A whooshing sound may be heard when the fuel tank cap is loosened. Wait until the sound cannot be heard before fully removing the cap. In hot weather, pressurized fuel may spray out of the filler neck and cause injury.
- Do not allow anyone that has not discharged static electricity from their body to come close to an open fuel tank.
- Do not inhale vaporized fuel.
Fuel contains substances that are harmful if inhaled.
- Do not smoke while refueling the vehicle.
Doing so may cause the fuel to ignite and cause a fire.
- Do not return to the vehicle or touch any person or object that is statically charged.
This may cause static electricity to build up, resulting in a possible ignition hazard.

 CAUTION**■ When refueling**

Observe the following precautions to prevent fuel overflowing from the fuel tank:

- Securely insert the fuel nozzle into the fuel filler neck
- Stop filling the tank after the fuel nozzle automatically clicks off
- Do not top off the fuel tank

■ When replacing the fuel tank cap

Do not use anything but a genuine Toyota fuel tank cap designed for your vehicle. Doing so may cause a fire or other incident which may result in death or serious injury.

 NOTICE**■ Refueling**

Do not spill fuel during refueling.

Doing so may damage the vehicle, such as causing the emission control system to operate abnormally or damaging fuel system components or the vehicle's painted surface.

1

Before driving

1-6. Theft deterrent system Engine immobilizer system

The vehicle's keys have built-in transponder chips that prevent the engine from starting if the key has not been previously registered in the vehicle's on-board computer.

Never leave the keys inside the vehicle when you leave the vehicle.

This system is designed to help prevent vehicle theft but does not guarantee absolute security against all vehicle thefts.

► Vehicles with manual air conditioning system

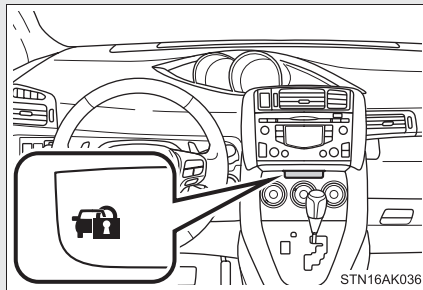

Vehicles without smart entry & start system: The indicator light flashes after the key has been removed from the engine switch to indicate that the system is operating.

The indicator light stops flashing after the registered key has been inserted into the engine switch to indicate that the system has been canceled.

Vehicles with smart entry & start system: The indicator light flashes after the "ENGINE START STOP" switch has been turned off to indicate that the system is operating.

The indicator light stops flashing after the "ENGINE START STOP" switch has been turned to ACCESSORY or IGNITION ON mode to indicate that the system has been canceled.

► Vehicles with automatic air conditioning system

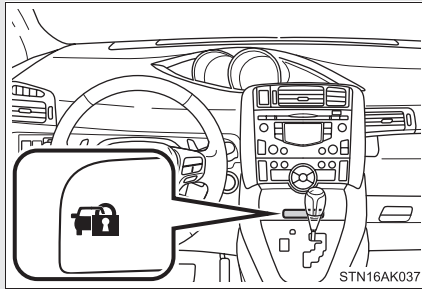

Vehicles without smart entry & start system: The indicator light flashes after the key has been removed from the engine switch to indicate that the system is operating.

The indicator light stops flashing after the registered key has been inserted into the engine switch to indicate that the system has been canceled.

Vehicles with smart entry & start system: The indicator light flashes after the “ENGINE START STOP” switch has been turned off to indicate that the system is operating.

The indicator light stops flashing after the “ENGINE START STOP” switch has been turned to ACCESSORY or IGNITION ON mode to indicate that the system has been canceled.

1

Before driving

1-6. Theft deterrent system

■ System maintenance

The vehicle has a maintenance-free type engine immobilizer system.

■ Conditions that may cause the system to malfunction

- If the grip portion of the key is in contact with a metallic object
- If the key is in close proximity to or touching a key to the security system (key with a built-in transponder chip) of another vehicle

■ Engine immobilizer certification (vehicles with smart entry & start system)

Hereby, Toyota Motor Corporation, declares that this TMIMB-2 is in compliance with the essential requirements and other relevant provisions of Directive 1999/5/EC.

1

Before driving

TOYOTA

TOYOTA MOTOR CORPORATION

1, TOYOTA-CHO, TOYOTA, AICHI, 471-8571(Head Office)
or 471-8572(Research & Development Group) JAPAN
TEL: +81-565-28-2121

R&TTE Declaration of Conformity

We,

Manufacturer's Name: TOYOTA MOTOR CORPORATION
Manufacturer's Address: 1, Toyota -cho, Toyota, Aichi, 471-8572, Japan

hereby declare under our sole responsibility that the product:

Product Name: Immobilizer
Product Model: TMIMB-2
to which this declaration relates is in conformity with the essential requirements and other relevant requirements of the R&TTE Directive (1999/5/EC). The product is compliant with the following standards and/or other normative documents:

- Health & safety requirements: EN60950-1
- EMC requirements: EN 301 489-01 & EN 301 489-03
- Effective uses of radio spectrum: EN 300 330-2

Supplementary information:

* CE mark	
* Member states intended for use	EU and EFTA

Date: January 21, 2008

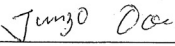
Signature: 
Junzo Ooe

1-6. Theft deterrent system

Hereby, Toyota Motor Corporation, declares that this TMIMB-2 is in compliance with the essential requirements and other relevant provisions of Directive 1999/5/EC.
Toyota Motor Corporation vakuuttaa täten että TMIMB-2 tyyppinen laite on direktiivin 1999/5/EY oleellisten vaatimusten ja sitä koskevien direktiivin muiden ehtojen mukainen.
Hierbij verklaart Toyota Motor Corporation dat het toestel TMIMB-2 in overeenstemming is met de essentiële eisen en de andere relevante bepalingen van richtlijn 1999/5/EG.
Par la présente Toyota Motor Corporation déclare que l'appareil TMIMB-2 est conforme aux exigences essentielles et aux autres dispositions pertinentes de la directive 1999/5/CE.
Härmed intygar Toyota Motor Corporation att denna TMIMB-2 står i överensstämmelse med de väsentliga egenskapskrav och övriga relevanta bestämmelser som framgår av direktiv 1999/5/EG.
Undertegnede Toyota Motor Corporation erklærer herved, at følgende udstyr TMIMB-2 overholder de væsentlige krav og øvrige relevante krav i direktiv 1999/5/EF.
Hiermit erklart Toyota Motor Corporation, dass sich das Gerät TMIMB-2 in Übereinstimmung mit den grundlegenden Anforderungen und den übrigen einschlägigen Bestimmungen der Richtlinie 1999/5/EG befindet.
ΜΕ ΤΗΝ ΠΑΡΟΥΣΑ Toyota Motor Corporation ΔΗΛΩΝΕΙ ΟΤΙ ΤΜΙΜΒ-2 ΣΥΜΜΟΡΦΩΝΕΤΑΙ ΠΡΟΣ ΤΙΣ ΟΥΣΙΩΔΕΙΣ ΑΠΑΙΤΗΣΕΙΣ ΚΑΙ ΤΙΣ ΛΟΙΠΕΣ ΣΧΕΤΙΚΕΣ ΔΙΑΤΑΞΕΙΣ ΤΗΣ ΟΔΗΓΙΑΣ 1999/5/ΕΚ.
Con la presente Toyota Motor Corporation dichiara che questo TMIMB-2 è conforme ai requisiti essenziali ed alle altre disposizioni pertinenti stabilite dalla direttiva 1999/5/CE.
Por medio de la presente Toyota Motor Corporation declara que el TMIMB-2 cumple con los requisitos esenciales y cualesquiera otras disposiciones aplicables o exigibles de la Directiva 1999/5/CE.
Toyota Motor Corporation declara que este TMIMB-2 está conforme com os requisitos essenciais e outras disposições da Directiva 1999/5/CE.
Hawnhekk, Toyota Motor Corporation, jiddikjara li dan TMIMB-2 jikkonforma mal-htigijiet essenzjali u ma provvedimenti oħrajn relevanti li hemm fid-Dirrettiva 1999/5/EC.

Käesolevaga kinnitab Toyota Motor Corporation seadme TMIMB-2 vastavust direktiivi 1999/5/EÜ põhinõuetele ja nimetatud direktiivist tulenevatele teistele asjakohastele sätetele.
Alulírott, Toyota Motor Corporation nyilatkozom, hogy a TMIMB-2 megfelel a vonatkozó alapvető követelményeknek és az 1999/5/EC irányelv egyéb előírásainak.
Toyota Motor Corporation tímto vyhlasuje, že TMIMB-2 splňa základné požiadavky a všetky príslušné ustanovenia Smernice 1999/5/ES.
Toyota Motor Corporation tímto prohlašuje, že tento TMIMB-2 je ve shodě se základními požadavky a dalšími příslušnými ustanoveními směrnice 1999/5/ES.
Toyota Motor Corporation izjavlja, da je ta TMIMB-2 v skladu z bistvenimi zahtevami in ostalimi relevantnimi določili direktive 1999/5/ES.
Šiuo Toyota Motor Corporation deklaruoja, kad šis TMIMB-2 atitinka esminius reikalavimus ir kitas 1999/5/EB Direktyvos nuostatas.
Ar šo Toyota Motor Corporation deklarē, ka TMIMB-2 atbilst Direktīvas 1999/5/EK būtiskajām prasībām un citiem ar to saistītajiem noteikumiem.
Niniejszym Toyota Motor Corporation oświadcza, że TMIMB-2 jest zgodny z zasadniczymi wymogami oraz pozostałymi stosownymi postanowieniami Dyrektywy 1999/5/EC.
Hér með lýsir Toyota Motor Corporation yfir því að TMIMB-2 er í samræmi við grunnkröfur og aðrar kröfur, sem gerðar eru í tilskipun 1999/5/EC.
Toyota Motor Corporation erklærer herved at utstyret TMIMB-2 er i samsvar med de grunnleggende krav og øvrige relevante krav i direktiv 1999/5/EF.
С настоящето, Toyota Motor Corporation, декларира, че TMIMB-2 е в съответствие със съществените изисквания и другите приложими разпоредби на Директива 1999/5/EC.
Prin prezenta, Toyota Motor Corporation, declară că aparatul TMIMB-2 este în conformitate cu cerințele esențiale și cu alte prevederi pertinente ale Directivei 1999/5/CE.

1-6. Theft deterrent system

Ovim, Toyota Motor Corporation, izjavljuje da ovaj TMIMB-2 je usklađen sa bitnim zahtjevima i drugim relevantnim odredbama Direktive 1999/5/EC.

Nepermjet kesaj, Toyota Motor Corporation, deklaruj qe ky TMIMB-2 eshte ne pajtim me kerkesat thelbesore dhe dispozitat e tjera perkatese te Direktives 1999/5/EC.

Ovim Toyota Motor Corporation, izjavljuje da je TMIMB-2 u skladu s bitnim zahtjevima i drugim relevantnim odredbama Direktive 1999/5/EC i Pravilnika o RiTT opremi (NN 25/2012).

Ovim, Toyota Motor Corporation, deklarirše da je TMIMB-2 u skladu sa osnovnim zahtevima i ostalim relevantnim odredbama Direktive 1999/5/EC.

■ **Engine immobilizer certification (vehicles without smart entry & start system)**

The DECLARATION of CONFORMITY (DoC) is available at the following address:

<http://www.tokai-rika.co.jp/pc/>



Hereby, TRCZ s.r.o., declares that this RI-37BTY is in compliance with the essential requirements and other relevant provisions of Directive 1999/5/EC.
TRCZ s.r.o. vakuuttaa täten että RI-37BTY tyyppinen laite on direktiivin 1999/5/EY oleellisten vaatimusten ja sitä koskevien direktiivin muiden ehtojen mukainen.
Hierbij verklaart TRCZ s.r.o. dat het toestel RI-37BTY in overeenstemming is met de essentiële eisen en de andere relevante bepalingen van richtlijn 1999/5/EG.
Par la présente TRCZ s.r.o. déclare que l'appareil RI-37BTY est conforme aux exigences essentielles et aux autres dispositions pertinentes de la directive 1999/5/CE.
Härmed intygar TRCZ s.r.o. att denna RI-37BTY står i överensstämmelse med de väsentliga egenskapskrav och övriga relevanta bestämmelser som framgår av direktiv 1999/5/EG.
Undertegnede TRCZ s.r.o. erklærer herved, at følgende udstyr RI-37BTY overholder de væsentlige krav og øvrige relevante krav i direktiv 1999/5/EF.
Hiermit erklärt TRCZ s.r.o., dass sich das Gerät RI-37BTY in Übereinstimmung mit den grundlegenden Anforderungen und den übrigen einschlägigen Bestimmungen der Richtlinie 1999/5/EG befindet.
ΜΕ ΤΗΝ ΠΑΡΟΥΣΑ TRCZ s.r.o. ΔΗΛΩΝΕΙ ΟΤΙ RI-37BTY ΣΥΜΜΟΡΦΩΝΕΤΑΙ ΠΡΟΣ ΤΙΣ ΟΥΣΙΩΔΕΙΣ ΑΠΑΙΤΗΣΕΙΣ ΚΑΙ ΤΙΣ ΛΟΙΠΕΣ ΣΧΕΤΙΚΕΣ ΔΙΑΤΑΞΕΙΣ ΤΗΣ ΟΔΗΓΙΑΣ 1999/5/ΕΚ.
Con la presente TRCZ s.r.o. dichiara che questo RI-37BTY è conforme ai requisiti essenziali ed alle altre disposizioni pertinenti stabilite dalla direttiva 1999/5/CE.
Por medio de la presente TRCZ s.r.o. declara que el RI-37BTY cumple con los requisitos esenciales y cualesquiera otras disposiciones aplicables o exigibles de la Directiva 1999/5/CE.

1

Before driving

1-6. Theft deterrent system

TRCZ s.r.o. declara que este RI-37BTY está conforme com os requisitos essenciais e outras disposições da Directiva 1999/5/CE.
Hawnhekk, TRCZ s.r.o., jiddikjara li dan RI-37BTY jikkonforma mal-htigijiet essenzjali u ma provvedimenti oħrajn relevanti li hemm fid-Dirrettiva 1999/5/EC.
Käesolevaga kinnitab TRCZ s.r.o. seadme RI-37BTY vastavust direktiivi 1999/5/EÜ põhinõuetele ja nimetatud direktiivist tulenevatele teistele asjakohastele sätetele.
Alulírott, TRCZ s.r.o. nyilatkozom, hogy a RI-37BTY megfelel a vonatkozó alapvető követelményeknek és az 1999/5/EC irányelv egyéb előírásainak.
TRCZ s.r.o. týmto vyhlasuje, že RI-37BTY splňa základné požiadavky a všetky príslušné ustanovenia Smernice 1999/5/ES.
TRCZ s.r.o. tímto prohlašuje, že tento RI-37BTY je ve shodě se základními požadavky a dalšími příslušnými ustanoveními směrnice 1999/5/ES.
TRCZ s.r.o. izjavlja, da je ta RI-37BTY v skladu z bistvenimi zahtevami in ostalimi relevantnimi določili direktive 1999/5/ES.
Šiuo TRCZ s.r.o. deklaruoja, kad šis RI-37BTY atitinka esminius reikalavimus ir kitas 1999/5/EB Direktyvos nuostatas.
Ar šo TRCZ s.r.o. deklarē, ka RI-37BTY atbilst Direktīvas 1999/5/EK būtiskajām prasībām un citiem ar to saistītajiem noteikumiem.
Niniejszym TRCZ s.r.o. oświadcza, że RI-37BTY jest zgodny z zasadniczymi wymogami oraz pozostałymi stosownymi postanowieniami Dyrektywy 1999/5/EC.
Hér með lýsir TRCZ s.r.o. yfir því að RI-37BTY er í samræmi við grunnkröfur og aðrar kröfur, sem gerðar eru í tilskipun 1999/5/EC.
TRCZ s.r.o. erklærer herved at utstyret RI-37BTY er i samsvar med de grunnleggende krav og øvrige relevante krav i direktiv 1999/5/EF.

С настоящето, TRCZ s.r.o., декларира, че RI-37BTY е в съответствие със съществените изисквания и другите приложими разпоредби на Директива 1999/5/EC.
Prin prezenta, TRCZ s.r.o., declară că aparatul RI-37BTY este în conformitate cu cerințele esențiale și cu alte prevederi pertinente ale Directivei 1999/5/CE.
Ovim, TRCZ s.r.o., izjavljuje da ovaj RI-37BTY je usklađen sa bitnim zahtjevima i drugim relevantnim odredbama Direktive 1999/5/EC.
Nepermjet kesaj, TRCZ s.r.o., deklaroi qe ky RI-37BTY eshte ne pajtim me kerkesat thelbesore dhe dispozitat e tjera perkatese te Direktives 1999/5/EC.
Ovim TRCZ s.r.o., izjavljuje da je RI-37BTY u skladu s bitnim zahtjevima i drugim relevantnim odredbama Direktive 1999/5/EC i Pravilnika o RITT opremi (NN 25/2012).
Ovim, TRCZ s.r.o., deklarirše da je RI-37BTY u skladu sa osnovnim zahtevima i ostalim relevantnim odredbama Direktive 1999/5/EC.

 NOTICE

■ **To ensure the system operates correctly**

Do not modify or remove the system. If modified or removed, the proper operation of the system cannot be guaranteed.

1-6. Theft deterrent system

Double locking system*

Unauthorized access to the vehicle is prevented by disabling the door unlocking function from both the interior and exterior of the vehicle.

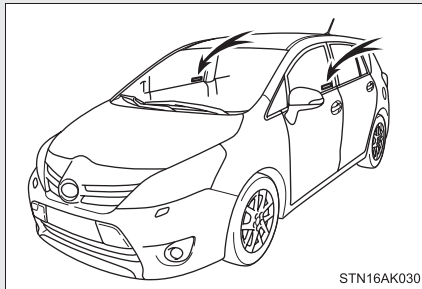

Vehicles employing this system have labels on the window glass of both front doors.

Setting the double locking system

► Vehicles without smart entry & start system

Turn the engine switch to the “LOCK” position, have all the passengers exit the vehicle and ensure that all the doors are closed.

Using the wireless remote control:

Press the  button twice within 5 seconds.

► Vehicles with smart entry & start system

Turn the “ENGINE START STOP” switch off, have all the passengers exit the vehicle and ensure that all the doors are closed.

Using the smart entry & start system:

Touch the sensor area on the outside door handle twice within 5 seconds.

Using the wireless remote control:

Press the  button twice within 5 seconds.

*: If equipped

Canceling the double locking system

Using the smart entry & start system (if equipped):
Hold the outside door handle on the driver's side.

Using the wireless remote control:
Press the  button.

CAUTION

■ Double locking system precaution

Never activate the double locking system when there are people in the vehicle, because all the doors cannot be opened from inside the vehicle.

1

Before driving

1-6. Theft deterrent system

Alarm*

The system sounds the alarm and flashes the lights when forcible entry is detected.

■ Triggering of the alarm

The alarm is triggered in the following situations when the alarm is set.

- A locked door is unlocked or opened in any way other than using the entry function (vehicles with smart entry & start system) or wireless remote control. (The doors will lock again automatically.)
- The hood is opened.
- Vehicles with the intrusion sensor: The intrusion sensor detects something moving inside the vehicle. (An intruder gets in the vehicle.)
- Vehicles with the glass breakage sensor: The back door window is tapped or broken.
- The battery is reconnected.

■ **Setting the alarm system**

▶ **Vehicles with manual air conditioning system**

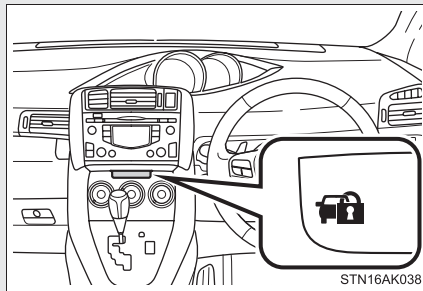

Close the doors and hood, and lock all the doors using the entry function (vehicles with smart entry & start system) or wireless remote control. The system will be set automatically after 30 seconds.

The indicator light changes from being on to flashing when the system is set.

▶ **Vehicles with automatic air conditioning system**

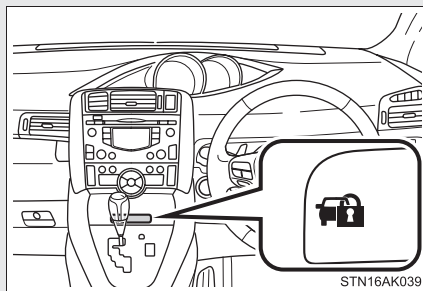

Close the doors and hood, and lock all the doors using the entry function (vehicles with smart entry & start system) or wireless remote control. The system will be set automatically after 30 seconds.

The indicator light changes from being on to flashing when the system is set.

1

Before driving

■ **Deactivating or stopping the alarm**

Do one of the following to deactivate or stop the alarm.

- Unlock the doors using the entry function (vehicles with smart entry & start system) or wireless remote control.
- Start the engine. (The alarm will be deactivated or stopped after a few seconds.)

Intrusion sensor (if equipped)

The intrusion sensor detects an intruder or movement in the vehicle.

The intrusion sensor can be canceled using the cancel switch.

This system is designed to deter and prevent vehicle theft but does not guarantee absolute security against all intrusions.

■ **Canceling the intrusion sensor**

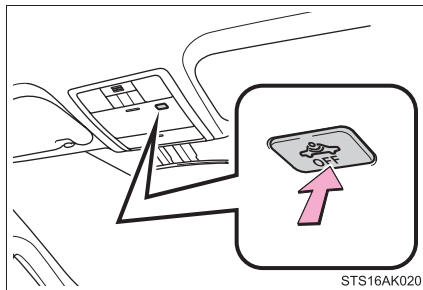

Vehicles without smart entry & start system: Turn the engine switch to the “LOCK” position and press the intrusion sensor cancel switch.

Vehicles with smart entry & start system: Turn the “ENGINE START STOP” switch off and press the intrusion sensor cancel switch.

Pressing the switch again will re-enable the intrusion sensor.

To cancel the intrusion sensor, perform the necessary procedure each time canceling the sensor is desired.

■ System maintenance

The vehicle has a maintenance-free type alarm system.

■ Items to check before locking the vehicle

To prevent unexpected triggering of the alarm and vehicle theft, make sure of the following.

- Nobody is in the vehicle.
- The windows is closed before the alarm is set.
- No valuables or other personal items are left in the vehicle.

■ Triggering of the alarm

The alarm may be triggered in the following situations. (Stopping the alarm deactivates the alarm system.)

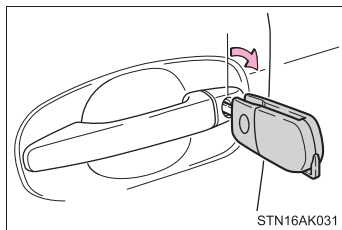

- The doors are unlocked using the mechanical key.



- A person inside the vehicle opens a door or hood.

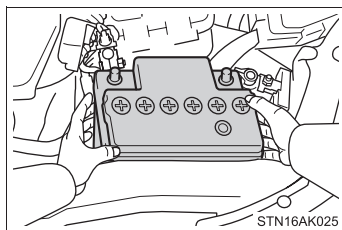

- The battery is recharged or replaced when the vehicle is locked.

■ **When the battery is disconnected**

Be sure to cancel the alarm system.

If the battery is discharged before canceling the alarm, the system may be triggered when the battery is reconnected.

■ **Alarm-operated door lock**

- When the alarm is operating, the doors are locked automatically to prevent intruders.
- Do not leave the key inside the vehicle when the alarm is operating, and make sure the key is not inside the vehicle when recharging or replacing the battery.

■ **Canceling and automatic re-enabling of the intrusion sensor**

- The alarm will still be set even when the intrusion sensor is canceled.
- Vehicles without smart entry & start system: After the intrusion sensor is canceled, turn the engine switch to the “ON” position or unlocking the doors using the wireless remote control will re-enable the intrusion sensor.
- Vehicles with smart entry & start system: After the intrusion sensor is canceled, pressing the “ENGINE START STOP” switch or unlocking the doors using the smart entry & start system or wireless remote control will re-enable the intrusion sensor.
- When the alarm system is set again, the intrusion sensor will also be set.

■ **Intrusion sensor considerations**

The sensor may trigger the alarm in the following situations.

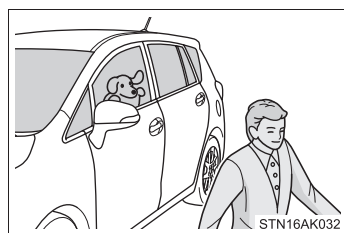

- Persons or pets are in the vehicle.

1-6. Theft deterrent system

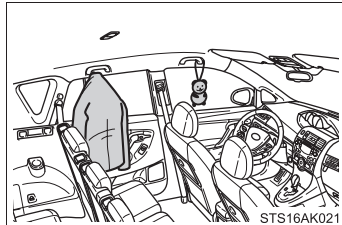

- Unstable items, such as dangling accessories or clothes hanging on the coat hooks, are in the vehicle.

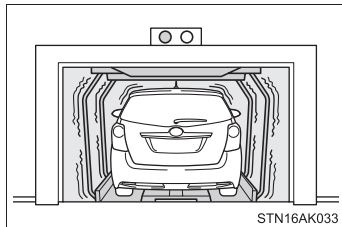

- The vehicle is parked in a place where extreme vibrations or noises occur, such as in a parking garage.

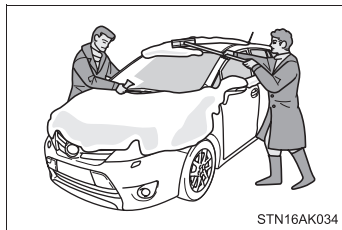

- Ice or snow is removed from the vehicle, causing the vehicle to receive repeated impacts or vibrations.

- Unstable items, such as dangling accessories or clothes hanging on the coat hooks, are in the vehicle.
- A window is open.
- The vehicle is inside an automatic or high-pressure car washer.
- The vehicle experiences impacts, such as hail, lightning strikes, or other kinds of repeated impacts or vibrations.

1

Before driving

1-6. Theft deterrent system

■ Certification

The latest “DECLARATION of CONFORMITY” (DoC) is available at the following:

DoC address: FUJITSU TEN LIMITED

2-28, Goshō-dori 1-chome, Hyogo-ku, Kobe, 652-8510,
Japan



The sensor installed to vehicles sold other than UK and Ireland is not allowed to operate in UK.

С настоящето, FUJITSU TEN LIMITED, декларира, че FTL313 е в съответствие със съществените изисквания и другите приложими разпоредби на Директива 1999/5/EC.
FUJITSU TEN LIMITED tímto prohlašuje, že tento FTL313 je ve shodě se základními požadavky a dalšími příslušnými ustanoveními směrnice 1999/5/ES.
Undertegnede FUJITSU TEN LIMITED erklærer herved, at følgende udstyr FTL313 overholder de væsentlige krav og øvrige relevante krav i direktiv 1999/5/EF.
Hiermit erklärt FUJITSU TEN LIMITED, dass sich das Gerät FTL313 in Übereinstimmung mit den grundlegenden Anforderungen und den übrigen einschlägigen Bestimmungen der Richtlinie 1999/5/EG befindet.
Käesolevaga kinnitab FUJITSU TEN LIMITED seadme FTL313 vastavust direktiivi 1999/5/EÜ põhinõuetele ja nimetatud direktiivist tulenevatele teistele asjakohastele sätetele.
Hereby, FUJITSU TEN LIMITED, declares that this FTL313 is in compliance with the essential requirements and other relevant provisions of Directive 1999/5/EC.
Por medio de la presente FUJITSU TEN LIMITED declara que el FTL313 cumple con los requisitos esenciales y cualesquiera otras disposiciones aplicables o exigibles de la Directiva 1999/5/CE.
ΜΕ ΤΗΝ ΠΑΡΟΥΣΑ FUJITSU TEN LIMITED ΔΗΛΩΝΕΙ ΟΤΙ FTL313 ΣΥΜΜΟΡΦΩΝΕΤΑΙ ΠΡΟΣ ΤΙΣ ΟΥΣΙΩΔΕΙΣ ΑΠΑΙΤΗΣΕΙΣ ΚΑΙ ΤΙΣ ΛΟΙΠΕΣ ΣΧΕΤΙΚΕΣ ΔΙΑΤΑΞΕΙΣ ΤΗΣ ΟΔΗΓΙΑΣ 1999/5/ΕΚ.
Par la présente FUJITSU TEN LIMITED déclare que l'appareil FTL313 est conforme aux exigences essentielles et aux autres dispositions pertinentes de la directive 1999/5/CE.

Con la presente FUJITSU TEN LIMITED dichiara che questo FTL313 è conforme ai requisiti essenziali ed alle altre disposizioni pertinenti stabilite dalla direttiva 1999/5/CE.
Ar šo FUJITSU TEN LIMITED deklarē, ka FTL313 atbilst Direktīvas 1999/5/EK būtiskajām prasībām un citiem ar to saistītajiem noteikumiem.
Šiuo FUJITSU TEN LIMITED deklaruoja, kad šis FTL313 atitinka esminius reikalavimus ir kitas 1999/5/EB Direktyvos nuostatas.
Hierbij verklaart FUJITSU TEN LIMITED dat het toestel FTL313 in overeenstemming is met de essentiële eisen en de andere relevante bepalingen van richtlijn 1999/5/EG.
Hawnhekk, FUJITSU TEN LIMITED, jiddikjara li dan FTL313 jikkonforma mal-ħtiġijiet essenzjali u ma provvedimenti oħrajn relevanti li hemm fid-Dirrettiva 1999/5/EC.
Alulírott, FUJITSU TEN LIMITED nyilatkozom, hogy a FTL313 megfelel a vonatkozó alapvető követelményeknek és az 1999/5/EC irányelv egyéb előírásainak.
Niniejszym FUJITSU TEN LIMITED oświadcza, że FTL313 jest zgodny z zasadniczymi wymogami oraz pozostałymi stosownymi postanowieniami Dyrektywy 1999/5/EC.
FUJITSU TEN LIMITED declara que este FTL313 está conforme com os requisitos essenciais e outras disposições da Directiva 1999/5/CE.
Prin prezenta, FUJITSU TEN LIMITED, declară că aparatul FTL313 este în conformitate cu cerințele esențiale și cu alte prevederi pertinente ale Directivei 1999/5/CE.
FUJITSU TEN LIMITED izjavlja, da je ta FTL313 v skladu z bistvenimi zahtevami in ostalimi relevantnimi določili direktive 1999/5/ES.
FUJITSU TEN LIMITED týmto vyhlasuje, že FTL313 spĺňa základné požiadavky a všetky príslušné ustanovenia Smernice 1999/5/ES.
FUJITSU TEN LIMITED vakuuttaa täten että FTL313 tyyppinen laite on direktiivin 1999/5/EY oleellisten vaatimusten ja sitä koskevien direktiivin muiden ehtojen mukainen.

1-6. Theft deterrent system

Härmed intygar FUJITSU TEN LIMITED att denna FTL313 står i överensstämmelse med de väsentliga egenskapskrav och övriga relevanta bestämmelser som framgår av direktiv 1999/5/EG.

Hér með lýsir FUJITSU TEN LIMITED yfir því að FTL313 er í samræmi við grunnkröfur og aðrar kröfur, sem gerðar eru í tilskipun 1999/5/EC.

FUJITSU TEN LIMITED erklærer herved at utstyret FTL313 er i samsvar med de grunnleggende krav og øvrige relevante krav i direktiv 1999/5/EF.

Ovim , FUJITSU TEN LIMITED, izjavljuje da ovaj FTL313 je usklađen sa bitnim zahtjevima i drugim relevantnim odredbama Direktive 1999/5/EC.

NOTICE

■ To ensure the system operates correctly

Do not modify or remove the system. If modified or removed, the proper operation of the system cannot be guaranteed.

1-7. Safety information

Correct driving posture

Drive with a good posture as follows:

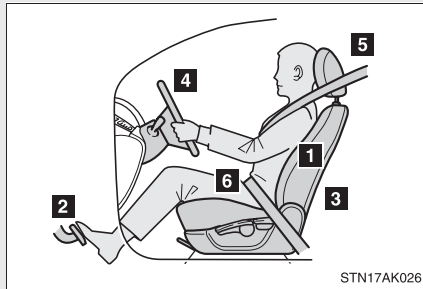

- 1** Sit upright and well back in the seat. (→P. 84)
- 2** Adjust the position of the seat forward or backward to ensure the pedals can be reached and easily depressed to the extent required. (→P. 84)
- 3** Adjust the seatback so that the controls are easily operable.
- 4** Adjust the tilt and telescopic positions of the steering wheel downward so the airbag is facing your chest. (→P. 104)
- 5** Lock the head restraint in place with the center of the head restraint closest to the top of your ears. (→P. 94)
- 6** Wear the seat belt correctly. (→P. 96)

1

Before driving

 CAUTION

■ **While driving**

- Do not adjust the position of the driver's seat.
Doing so could cause the driver to lose control of the vehicle.
- Do not place a cushion between the driver or passenger and the seatback.
A cushion may prevent correct posture from being achieved, and reduce the effectiveness of the seat belt and head restraint, increasing the risk of death or serious injury to the driver or passenger.
- Do not place anything under the front seats except for putting them in the auxiliary box.
Objects placed under the front seats may become jammed in the seat tracks and stop the seat from locking in place. This may lead to an accident, resulting in death or serious injury. The adjustment mechanism may also be damaged.

■ **Adjusting the seat position**

- Do not recline the seat more than necessary when the vehicle is in motion, to reduce the risk of sliding under the lap belt.
If the seat is too reclined during an accident, the lap belt may slide past the hips and apply restraint forces directly to the abdomen or your neck may contact the shoulder belt, increasing the risk of death or serious injury.
- Take care when adjusting the seat position to ensure that other passengers are not injured by the moving seat.
- Do not put your hands under the seat or near the moving parts to avoid injury.
Fingers or hands may become jammed in the seat mechanism.

1-7. Safety information

SRS airbags

The SRS airbags inflate when the vehicle is subjected to certain types of severe impacts that may cause significant injury to the occupants. They work together with the seat belts to help reduce the risk of death or serious injury.

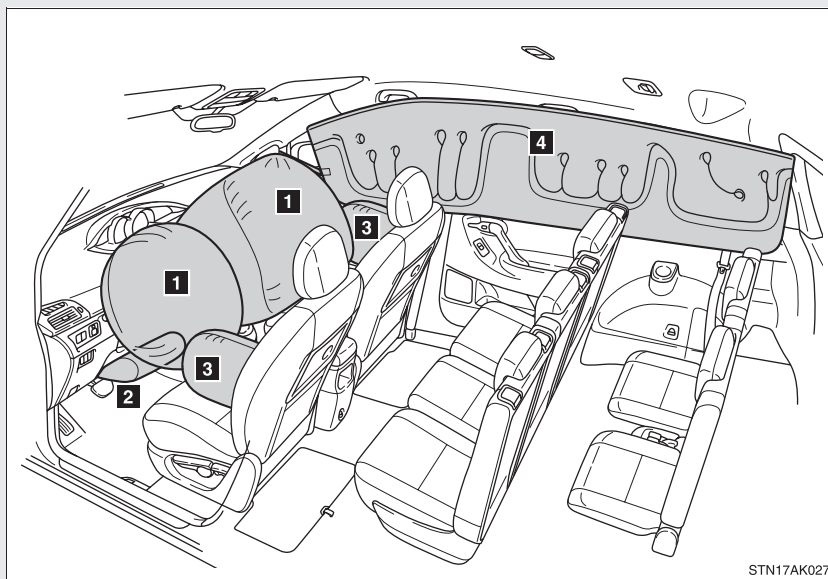

► SRS front airbags

1 SRS driver airbag/front passenger airbag

Can help protect the head and chest of the driver and front passenger from impact with interior components.

2 SRS knee airbag

Can help provide driver protection.

► SRS side and curtain shield airbags

3 SRS side airbags

Can help protect the torso of the front seat occupants.

4 SRS curtain shield airbags (if equipped)

Can help protect primarily the head of occupants in the outer seats.

1

Before driving

Airbag system components

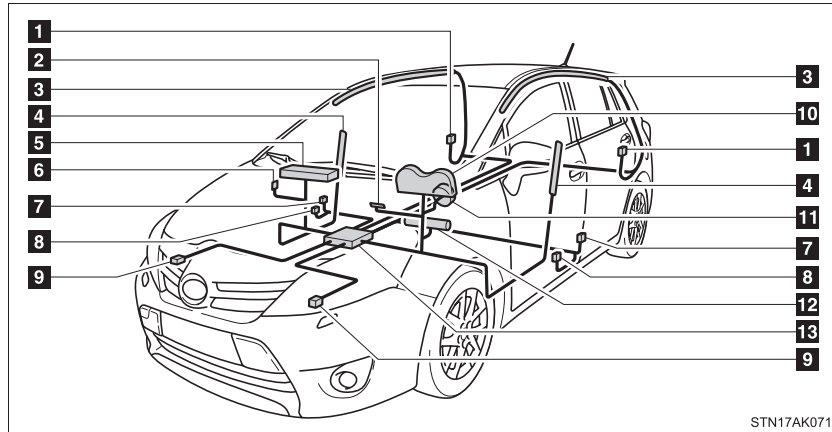

- | | |
|--|---|
| 1 Curtain shield airbag sensors (if equipped) | 7 ▶ Vehicles without curtain shield airbag: Side airbag sensors |
| 2 Passenger airbag indicator light | ▶ Vehicles with curtain shield airbag: Side and curtain shield airbag sensors |
| 3 Curtain shield airbags (if equipped) | |
| 4 Side airbags | |
| 5 Front passenger airbag | 8 Seat belt pretensioners and force limiters |
| 6 Airbag manual on-off switch | 9 Front airbag sensors |
| | 10 SRS warning light |
| | 11 Driver airbag |
| | 12 Knee airbag |
| | 13 Airbag sensor assembly |

The main SRS airbag system components are shown above. The SRS airbag system is controlled by the airbag sensor assembly. As the airbags deploy, a chemical reaction in the inflators quickly fills the airbags with non-toxic gas to help restrain the motion of the occupants.

■ If the SRS airbags deploy (inflate)

- Bruising and slight abrasions may result from contact with a deploying (inflating) SRS airbag.
- A loud noise and white powder will be emitted.
- Vehicles without SRS curtain shield airbags: Parts of the airbag module (steering wheel hub, airbag cover and inflator) as well as the front seats may be hot for several minutes. The airbag itself may also be hot.
- Vehicles with SRS curtain shield airbags: Parts of the airbag module (steering wheel hub, airbag cover and inflator) as well as the front seats, parts of the front and rear pillars, and roof side rails, may be hot for several minutes. The airbag itself may also be hot.
- The windshield may crack.

■ Operating conditions (SRS front airbags)

- The SRS front airbags will deploy in the event of an impact that exceeds the set threshold level (the level of force corresponding to an approximately 20 - 30 km/h [12 - 18 mph] frontal collision with a fixed wall that does not move or deform).

However, this threshold velocity will be considerably higher in the following situations:

- If the vehicle strikes an object, such as a parked vehicle or sign pole, which can move or deform on impact
- If the vehicle is involved in an underride collision, such as a collision in which the front of the vehicle “underrides”, or goes under, the bed of a truck
- Depending on the type of collision, it is possible that only the seat belt pretensioners will activate.

■ Operating conditions (SRS side airbags and curtain shield airbags [if equipped])

The SRS side airbags and curtain shield airbags (if equipped) will deploy in the event of an impact that exceeds the set threshold level (the level of force corresponding to the impact force produced by an approximately 1500 kg [3300 lb.] vehicle colliding with the vehicle cabin from a direction perpendicular to the vehicle orientation at an approximate speed of 20 - 30 km/h [12 - 18 mph]).

■ **Conditions under which the SRS airbags may deploy (inflate), other than a collision**

The SRS front airbags may also deploy if a serious impact occurs to the underside of your vehicle. Some examples are shown in the illustration.

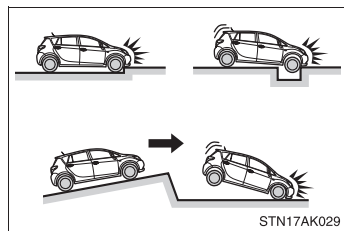

- Hitting a curb, edge of pavement or hard surface
- Falling into or jumping over a deep hole
- Landing hard or vehicle falling

■ **Types of collisions that may not deploy the SRS airbags (SRS front airbags)**

The SRS front airbags are generally not designed to inflate if the vehicle is involved in a side or rear collision, if it rolls over, or if it is involved in a low-speed frontal collision. But, whenever a collision of any type causes sufficient forward deceleration of the vehicle, deployment of the SRS front airbags may occur.

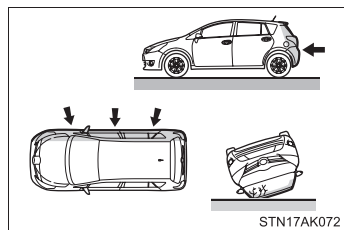

- Collision from the side
- Collision from the rear
- Vehicle rollover

■ **Types of collisions that may not deploy the SRS airbags (SRS side airbags and curtain shield airbags [if equipped])**

The SRS side airbags and curtain shield airbags (if equipped) system may not activate if the vehicle is subjected to a collision from the side at certain angles, or a collision to the side of the vehicle body other than the passenger compartment.

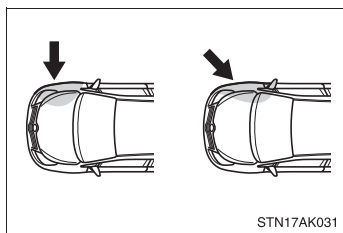

- Collision from the side to the vehicle body other than the passenger compartment
- Collision from the side at an angle

The SRS side airbags and curtain shield airbags (if equipped) are not generally designed to inflate if the vehicle is involved in a frontal or rear collision, if it rolls over, or if it is involved in a low-speed side collision.

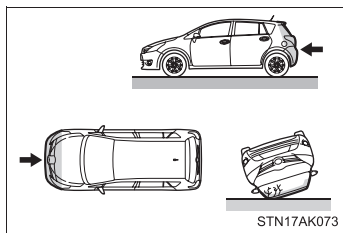

- Collision from the front
- Collision from the rear
- Vehicle rollover

1

Before driving

■ **When to contact any authorized Toyota dealer or repairer, or another duly qualified and equipped professional**

In the following cases, the vehicle will require inspection and/or repair. Contact any authorized Toyota dealer or repairer, or another duly qualified and equipped professional, as soon as possible.

- Any of the SRS airbags have been inflated.

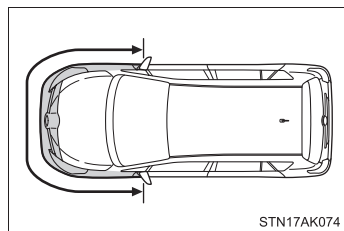

- The front of the vehicle is damaged or deformed, or was involved in an accident that was not severe enough to cause the SRS front airbags to inflate.

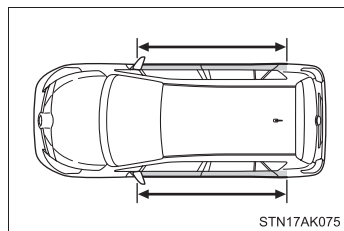

- A portion of the doors is damaged or deformed, or the vehicle was involved in an accident that was not severe enough to cause the SRS side airbags and curtain shield airbags (if equipped) to inflate.

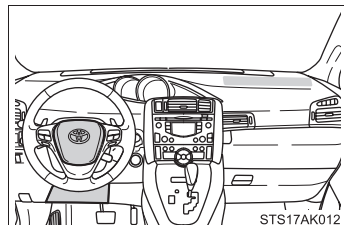

- The pad section of the steering wheel, dashboard near the front passenger airbag or lower portion of the instrument panel is scratched, cracked, or otherwise damaged.

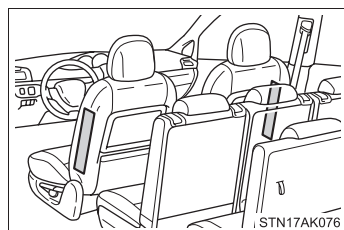

- The surface of the seats with the SRS side airbag is scratched, cracked or otherwise damaged.

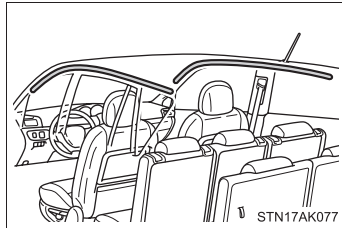

- Vehicles with SRS curtain shield airbags: The portion of the front, center and rear pillar garnish, or roof side rail garnishes containing the curtain shield airbags inside is scratched, cracked or otherwise damaged.

1

Before driving

⚠ CAUTION

■ SRS airbag precautions

Observe the following precautions regarding the SRS airbags. Failure to do so may cause death or serious injury.

- The driver and all passengers in the vehicle must wear their seat belts properly.

The SRS airbags are supplemental devices to be used with the seat belts.

- The SRS driver airbag deploys with considerable force, and can cause death or serious injury especially if the driver is very close to the airbag.

Since the risk zone for the driver's airbag is the first 50 - 75 mm (2 - 3 in.) of inflation, placing yourself 250 mm (10 in.) from your driver airbag provides you with a clear margin of safety. This distance is measured from the center of the steering wheel to your breastbone. If you sit less than 250 mm (10 in.) away now, you can change your driving position in several ways:

- Move your seat to the rear as far as you can while still reaching the pedals comfortably.
- Slightly recline the back of the seat.
Although vehicle designs vary, many drivers can achieve the 250 mm (10 in.) distance, even with the driver seat all the way forward, simply by reclining the back of the seat somewhat. If reclining the back of your seat makes it hard to see the road, raise yourself by using a firm, non-slippery cushion, or raise the seat if your vehicle has that feature.
- If your steering wheel is adjustable, tilt it downward. This points the airbag toward your chest instead of your head and neck.

The seat should be adjusted as recommended above, while still maintaining control of the foot pedals, steering wheel, and your view of the instrument panel controls.

⚠ CAUTION

■ SRS airbag precautions

- The SRS front passenger airbag also deploys with considerable force, and can cause death or serious injury especially if the front passenger is very close to the airbag. The front passenger seat should be as far from the airbag as possible with the seatback adjusted, so the front passenger sits upright.
- Improperly seated and/or restrained infants and children can be killed or seriously injured by a deploying airbag. An infant or child who is too small to use a seat belt should be properly secured using a child restraint system. Toyota strongly recommends that all infants and children be placed in the rear seats of the vehicle and properly restrained. The rear seats are safest for infants and children than the front passenger seat. (→P. 158)

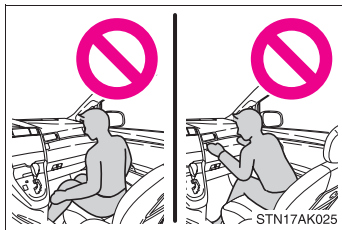

- Do not sit on the edge of the seat or lean against the dashboard.

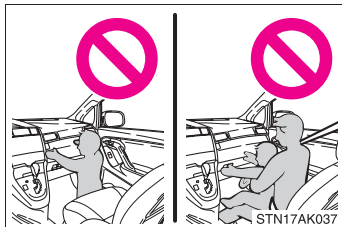

- Do not allow a child to stand in front of the SRS front passenger airbag unit or sit on the knees of a front passenger.
- Do not drive the vehicle while the driver or passenger have items resting on their knees.

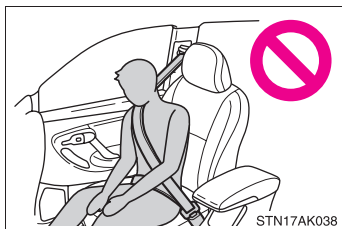

- Vehicles without SRS curtain shield airbags: Do not lean against the front door.
- Vehicles with SRS curtain shield airbags: Do not lean against the door, the roof side rail or the front, center and rear pillars.

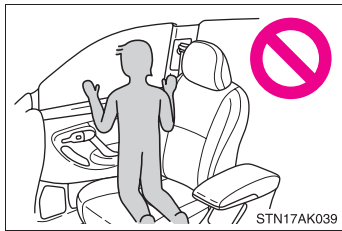
⚠ CAUTION**■ SRS airbag precautions**

- Do not allow anyone to kneel on the passenger seats toward the door or put their head or hands outside the vehicle.

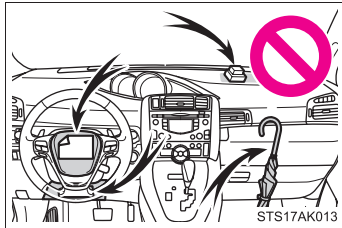

- Do not attach anything to or lean anything against areas such as the dashboard, steering wheel pad or lower portion of the instrument panel. These items can become projectiles when SRS driver, front passenger and knee airbags deploy.

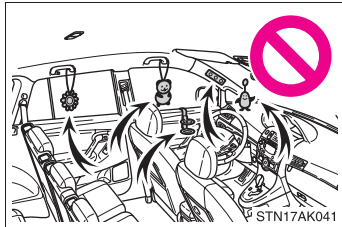

- Vehicles without SRS curtain shield airbags: Do not attach anything to areas such as a door, windshield glass and side door glass.
- Vehicles with SRS curtain shield airbags: Do not attach anything to areas such as the door, windshield glass, side door glass, front, center and rear pillars, roof side rail or assist grip. (Except for the speed limit label →P. 543)

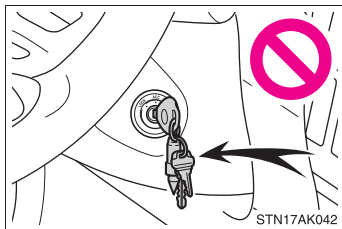

- Vehicles without smart entry & start system: Do not attach any heavy, sharp or hard objects such as keys or accessories to the key. The objects may restrict the SRS knee airbag inflation or be thrust into the driver's seat area by the force of the deploying airbag, thus causing a danger.

 CAUTION

■ **SRS airbag precautions**

- Vehicles with SRS curtain shield airbags: Do not hang coat hangers or other hard objects on the coat hooks. All of these items could become projectiles and may cause death or serious injury, should the SRS curtain shield airbag deploy.
- If the vinyl cover is put on the area where the SRS knee airbag will deploy, be sure to remove it.
- Do not use seat accessories which cover the parts where the SRS side airbags inflate as they may interfere with inflation of the airbags. Such accessories may prevent the side airbags from activating correctly, disable the system or cause the side airbags to inflate accidentally, resulting in death or serious injury.
- Do not strike or apply significant levels of force to the area of the SRS airbag components. (→P. 148)
Doing so can cause the SRS airbags to malfunction.
- Do not touch any of the component parts immediately after the SRS airbags have deployed (inflated) as they may be hot.
- If breathing becomes difficult after the SRS airbags have deployed, open a door or window to allow fresh air in, or leave the vehicle if it is safe to do so. Wash off any residue as soon as possible to prevent skin irritation.
- Vehicles without SRS curtain shield airbags: If the areas where the SRS airbags are stored, such as the steering wheel pad, are damaged or cracked, have them replaced by any authorized Toyota dealer or repairer, or another duly qualified and equipped professional.
- Vehicles with SRS curtain shield airbags: If the areas where the SRS airbags are stored, such as the steering wheel pad and front and rear pillar garnishes, are damaged or cracked, have them replaced by any authorized Toyota dealer or repairer, or another duly qualified and equipped professional.

⚠ CAUTION**■ Modification and disposal of SRS airbag system components**

Do not dispose of your vehicle or perform any of the following modifications without consulting any authorized Toyota dealer or repairer, or another duly qualified and equipped professional.

The SRS airbags may malfunction or deploy (inflate) accidentally, causing death or serious injury.

- Installation, removal, disassembly and repair of the SRS airbags.
- Repairs, modifications, removal or replacement of the steering wheel, instrument panel, dashboard, seats or seat upholstery, front, center and rear pillars or roof side rail.
- Repairs or modifications of the front fender, front bumper, or side of the occupant compartment.
- Installation of a grille guard (bull bars, kangaroo bar, etc.), snow plows or winches.
- Modifications to the vehicle's suspension system.
- Installation of electronic devices such as mobile two-way radios (RF-transmitter) and CD players.

1

Before driving

1-7. Safety information

Child restraint systems

Toyota strongly urges the use of child restraint systems.

Points to remember

Studies have shown that installing a child restraint system on a rear seat is much safer than installing one on the front passenger seat.

- Choose a child restraint system that suits your vehicle and is appropriate to the age and size of the child.
- For installation details, follow the instructions provided with the child restraint system.
General installation instructions are provided in this manual.
(→P. 166)
- If child restraint system regulations exist in the country where you reside, please contact your Toyota dealer or repairer, or another duly qualified and equipped professional for the child restraint system installation.
- Toyota recommends that you use a child restraint system which conforms to the regulation “ECE No.44”.

Types of child restraints

Child restraint systems are classified into the following 5 groups according to the regulation “ECE No.44”.

Group 0: Up to 10 kg (22 lb.) (0 - 9 months)

Group 0⁺: Up to 13 kg (28 lb.) (0 - 2 years)

Group I: 9 to 18 kg (20 to 39 lb.) (9 months - 4 years)

Group II: 15 to 25 kg (34 to 55 lb.) (4 years - 7 years)

Group III: 22 to 36 kg (49 to 79 lb.) (6 years - 12 years)

In this owner's manual, the following 3 types of popular child restraint systems that can be secured with the seat belts are explained.

► Baby seat

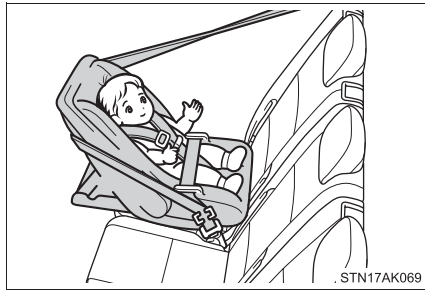

Equal to Group 0 and 0⁺ of "ECE No.44"

► Child seat



Equal to Group 0⁺ and I of "ECE No.44"

► Junior seat

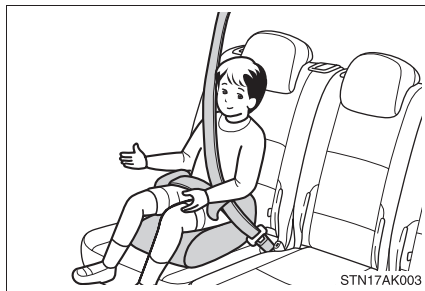

Equal to Group II and III of "ECE No.44"

Child restraint system suitability for various seating positions

Provided information in the table shows your child restraint system suitability for various seating positions.

Seating position Mass group	Front passenger seat		Second seat			Third seat	
	Airbag manual on-off switch		Driver side	Passenger side	Center	Driver side	Passenger side
	ON	OFF					
0 Up to 10 kg (22 lb.) (0 - 9 months)	X Never put	U	U	U	U	U	U
0 ⁺ Up to 13 kg (28 lb.) (0 - 2 years)	X Never put	U	U	U	U	U	U
I 9 to 18 kg (20 to 39 lb.) (9 months - 4 years)	U		U	U	U	U	U
II, III 15 to 36 kg (34 to 79 lb.) (4 - 12 years)	U		U	U	U	U	U

NOTE:

When you use child restraint system on the passenger seat, you must turn off the cut off switch.

Also, vehicles with a vertical height adjustment lever, must have the seat cushion adjusted to the highest position.

Key of letters inserted in the above table:

U: Suitable for “universal” category child restraint system approved for the use in this mass group.

X: Not suitable seat position for children in this mass group.

The child restraint systems mentioned in the table may not be available outside of the EU area.

NOTE:

Other child restraint system which is different from the system mentioned in the table can be used, but the suitability of the systems must be carefully checked with the child restraint system manufacturer concerned and the seller of those seats.

1

Before driving

**Child restraint system suitability for various seating positions
(with ISOFIX rigid anchor)**

Provided information in the table shows your child restraint system suitability for various seating positions.

Mass group	Size class	Fixture	Vehicle ISOFIX position
			Outside second seats
Carrycot	F	ISO/L1	X
	G	ISO/L2	X
0 Up to 10 kg (22 lb.) (0 - 9 months)	E	ISO/R1	X
0+ Up to 13 kg (28 lb.) (0 - 2 years)	E	ISO/R1	X
	D	ISO/R2	X
	C	ISO/R3	X
I 9 to 18 kg (20 to 39 lb.) (9 months - 4 years)	D	ISO/R2	X
	C	ISO/R3	X
	B	ISO/F2	IUF
	B1	ISO/F2X	IUF
II 15 to 25 kg (34 to 55 lb.) (4 years - 7 years)	-	-	X
	-	-	X
III 22 to 36 kg (49 to 79 lb.) (6 years - 12 years)	-	-	X

Key of letters inserted in the above table:

IUF: Suitable for ISOFIX forward child restraint systems of universal category approved for the use in this mass group.

X: ISOFIX position not suitable for ISOFIX child restraint systems in the mass group and/or size class.

The child restraint systems mentioned in the table may not be available outside of the EU area.

NOTE:

Other child restraint system which is different from the system mentioned in the table can be used, but the suitability of the systems must be carefully checked with the child restraint system manufacturer concerned and the seller of those seats.

■ **When installing the child restraint system on the front passenger seat adjust the following:**



- The seat as far back as possible
- The seatback to the most upright position
- The seat cushion to the highest position (if equipped)
- The seat belt height to the lowest position

■ **Selecting an appropriate child restraint system**

- Use a child restraint system appropriate for the child until the child becomes large enough to properly wear the vehicle's seat belt.
- If the child is too large for a child restraint system, sit the child on a rear seat and use the vehicle's seat belt. (→P. 96)

 CAUTION

■ **Using a child restraint system**

The use of a child restraint system not suitable for the vehicle may not properly secure the infant or child. It may result in death or serious injury (in the event of sudden braking or an accident).

■ **Child restraint precautions**

- For effective protection in automobile accidents and sudden stops, a child must be properly restrained, using a seat belt or child restraint system depending on the age and size of the child. Holding a child in your arms is not a substitute for a child restraint system. In an accident, the child can be crushed against the windshield, or between you and the vehicle's interior.
- Toyota strongly urges the use of a proper child restraint system that conforms to the size of the child, installed on the rear seat. According to accident statistics, the child is safer when properly restrained in the rear seat than in the front seat.
- Never install a rear-facing child restraint system on the front passenger seat when the airbag manual on-off switch is "ON". (→P. 178)
In the event of an accident, the force of the rapid inflation of the front passenger airbag can cause death or serious injury to the child.
- A forward-facing child restraint system may be installed on the front passenger seat only when it is unavoidable. A child restraint system that requires a top tether strap should not be used in the front passenger seat since there is no top tether strap anchor for the front passenger seat. Adjust the seatback as upright as possible and always move the seat as far back as possible because the front passenger airbag could inflate with considerable speed and force. Otherwise, the child may be killed or seriously injured.
- Vehicles without SRS curtain shield airbags: Do not allow the child to lean his/her head or any part of his/her body against the door or the area of the seat from which the SRS side airbags deploy even if the child is seated in the child restraint system. It is dangerous if the SRS side airbags inflate, and the impact could cause death or serious injury to the child.

 CAUTION**■ Child restraint precautions**

- Vehicles with SRS curtain shield airbags: Do not allow the child to lean his/her head or any part of his/her body against the door or the area of the seat, front and rear pillars or roof side rails from which the SRS side airbags or SRS curtain shield airbags deploy even if the child is seated in the child restraint system. It is dangerous if the SRS side airbags and SRS curtain shield airbags inflate, and the impact could cause death or serious injury to the child.
- Make sure you have complied with all installation instructions provided by the child restraint manufacturer and that the system is properly secured. If it is not secured properly, it may cause death or serious injury to the child in the event of a sudden stop, sudden swerve or an accident.

■ When children are in the vehicle

Do not allow children to play with the seat belt. If the seat belt becomes twisted around a child's neck, it may lead to choking or other serious injuries that could result in death.

If this occurs and the buckle cannot be unfastened, scissors should be used to cut the belt.

■ When the child restraint system is not in use

- Keep the child restraint system properly secured on the seat even if it is not in use. Do not store the child restraint system unsecured in the passenger compartment.
- If it is necessary to detach the child restraint system, remove it from the vehicle or store it securely in the luggage compartment. This will prevent it from injuring passengers in the event of a sudden stop, sudden swerve or accident.

1-7. Safety information

Installing child restraints

Follow the child restraint system manufacturer's instructions. Firmly secure the child restraints to the seats using a seat belt or ISOFIX rigid anchor. Attach the top strap when installing a child restraint system.

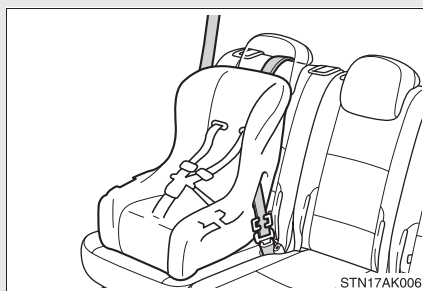

Seat belts (An ELR belt requires a locking clip.)

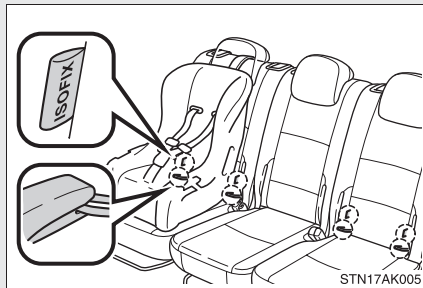

Second seat: ISOFIX rigid anchor (ISOFIX child restraint system)

Lower anchors are provided for the outside second seats. (Tags displaying the location of the anchors are attached to the seats.)

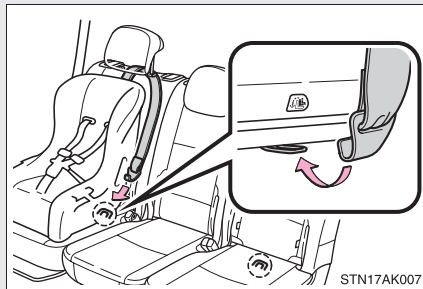

Second seat: Anchor bracket (for top strap)

Anchor brackets are provided for outside second seats.

Installing child restraints using a seat belt

■ **Rear-facing — Baby seat/child seat**

▶ **Second seats**

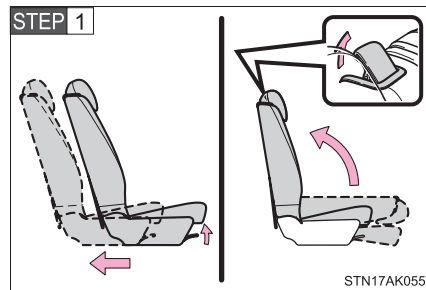

Adjust the seat as far back as possible. Fold the seatback while pulling up the seatback angle adjustment lever. Return the seatback and secure it at the 1st lock position (most upright position). (→P. 86)

▶ **Third seats (vehicles with third seats)**

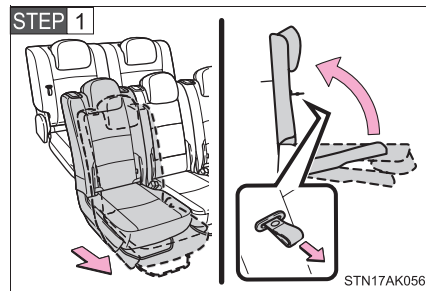

Adjust the second seat forward so that it does not interfere with the child restraint system.

Fold the seatback while pulling the seatback angle adjustment strap. Return the seatback and secure it at the 1st lock position (most upright position). (→P. 87)

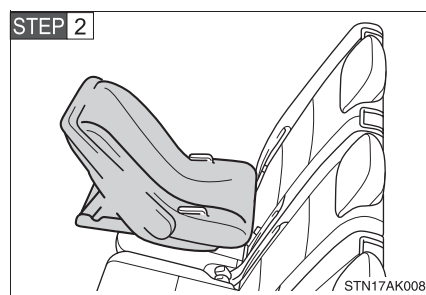

Place the child seat on the rear seat facing the rear of the vehicle.

1

Before driving

1-7. Safety information

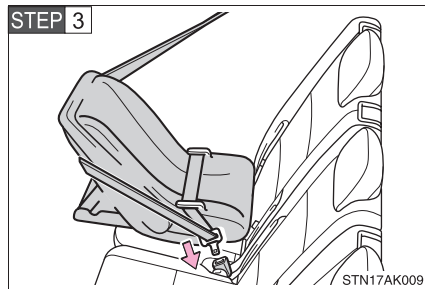

Run the seat belt through the child seat and insert the plate into the buckle. Make sure that the belt is not twisted.

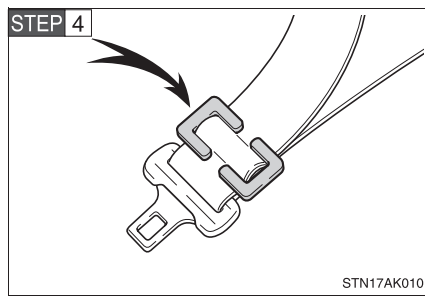

Install a locking clip near the tab of the lap and shoulder belt by inserting the lap and shoulder webbing through the recesses of the locking clip. Buckle the belt again. If the belt has any slack, release the buckle and reinstall the locking clip.

■ Forward-facing — Child seat

▶ Second seats

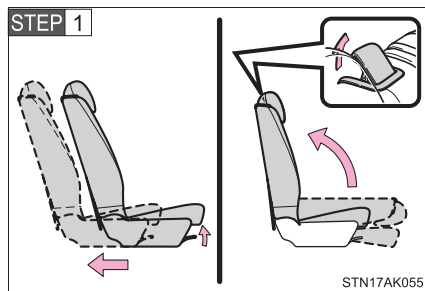

Adjust the seat as far back as possible.

Fold the seatback while pulling up the seatback angle adjustment lever. Return the seatback and secure it at the 1st lock position (most upright position).

(→P. 86)

► Third seats (vehicles with third seats)

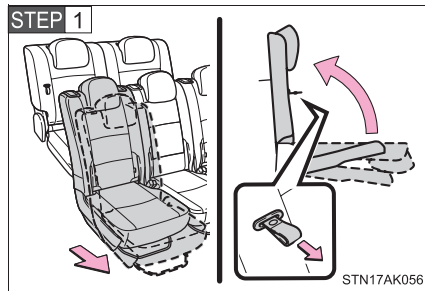

Adjust the second seat forward so that it does not interfere with the child restraint system.

Fold the seatback while pulling the seatback angle adjustment strap. Return the seatback and secure it at the 1st lock position (most upright position). (→P. 87)

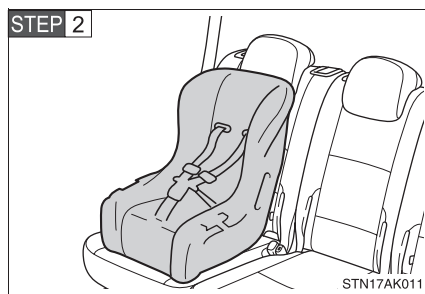

Place the child seat on the seat facing the front of the vehicle.

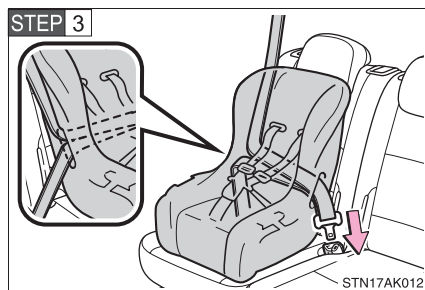

Run the seat belt through the child seat and insert the plate into the buckle. Make sure that the belt is not twisted.

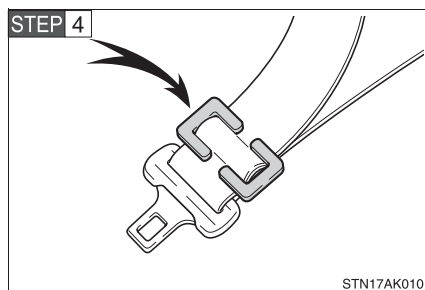

Install a locking clip near the tab of the lap and shoulder belt by inserting the lap and shoulder webbing through the recesses of the locking clip. Buckle the belt again. If the belt has any slack, release the buckle and reinstall the locking clip.

1

Before driving

■ Junior seat

► Second seats

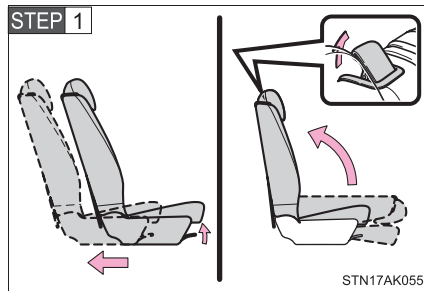

Adjust the seat as far back as possible.

Fold the seatback while pulling up the seatback angle adjustment lever. Return the seatback and secure it at the 1st lock position (most upright position).

(→P. 86)

► Third seats (vehicles with third seats)

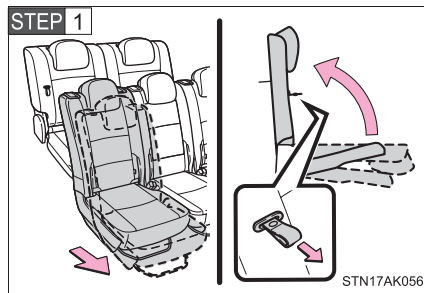

Adjust the second seat forward so that there is adequate space for the child.

Fold the seatback while pulling the seatback angle adjustment strap. Return the seatback and secure it at the 1st lock position (most upright position). (→P. 87)

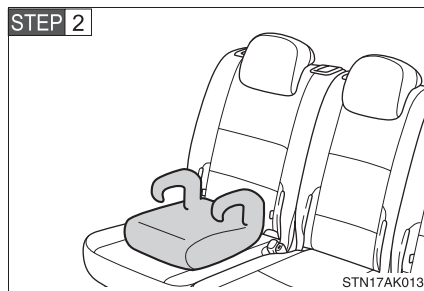

Place the junior seat on the seat facing the front of the vehicle.

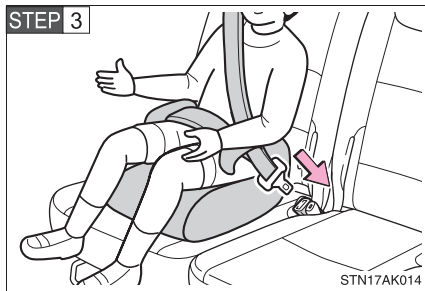

Sit the child in the junior seat. Fit the seat belt to the junior seat according to the manufacturer's instructions and insert the plate into the buckle. Make sure that the belt is not twisted.

Check that the shoulder belt is correctly positioned over the child's shoulder, and that the lap belt is as low as possible.
(→P. 96)

1

Before driving

Removing a child restraint system installed with a seat belt

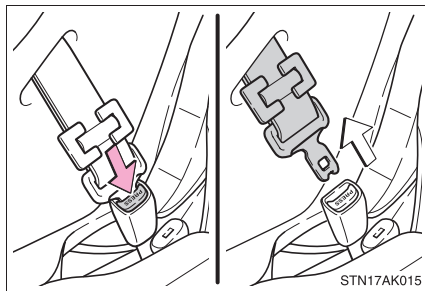

Push the release button and fully retract the seat belt.

Installation with ISOFIX rigid anchor (ISOFIX child restraint system) (vehicles with second seats)

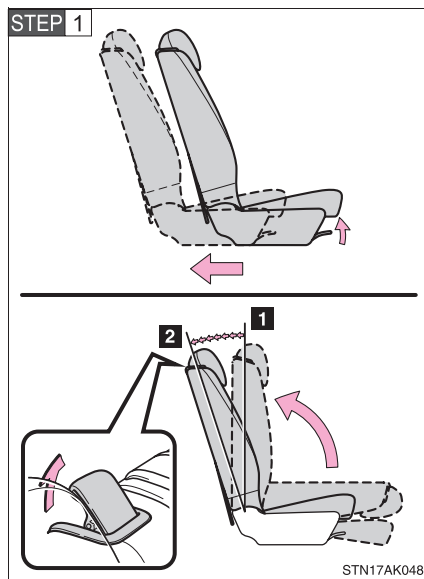

Adjust the seat as far back as possible.

Fold the seatback forward and then back to the 1st lock position (most upright position). Adjust the seatback to the 7th lock position. (→P. 86)

- 1 1st lock position
- 2 7th lock position

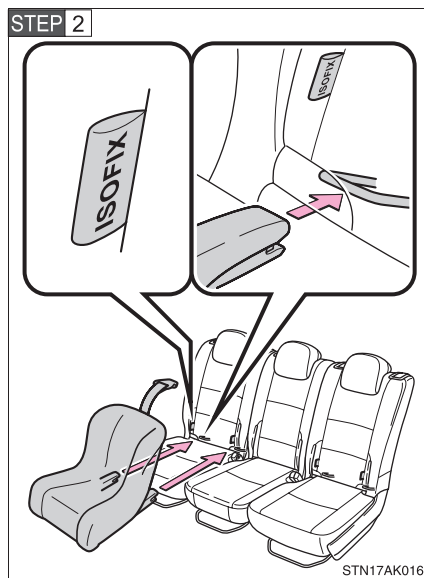

Check the positions of the lower anchors, and install the child restraint system to the seat.

If the child restraint has a top strap, the top strap should be latched onto the anchors.

Child restraint systems with a top strap (vehicles with second seats)

STEP 1 Secure the child restraint using a seat belt or ISOFIX rigid anchors, and do the following.

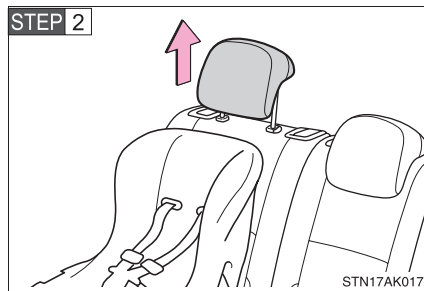

Adjust the head restraint to the upmost position. (→P. 94)

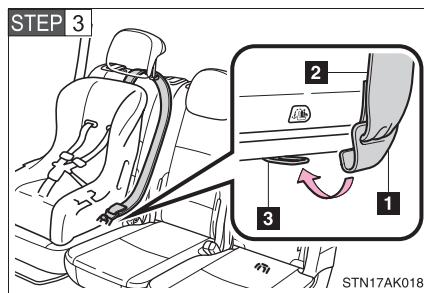

Latch the hook onto the anchor bracket and tighten the top strap.

Make sure the top strap is securely latched.

- 1** Hook
- 2** Top strap
- 3** Anchor bracket

1

Before driving

■ **When installing a child restraint system using a seat belt**

You need a locking clip to install the child restraint system using a seat belt. Follow the instructions provided by the manufacturer of the system. If your child restraint system does not provide a locking clip, you can purchase the following item from any authorized Toyota dealer or repairer, or another duly qualified and equipped professional.

Locking clip for child restraint system
(Part No. 73119-22010)

⚠ CAUTION

■ When installing a child restraint system

Follow the directions given in the child restraint system installation manual and fix the child restraint system securely in place.

If the child restraint system is not correctly fixed in place, the child or other passengers may be seriously injured or even killed in the event of sudden braking, sudden swerving or an accident.

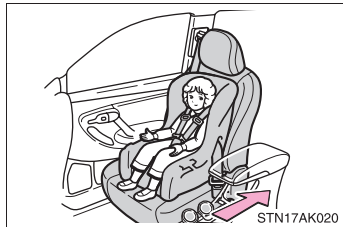
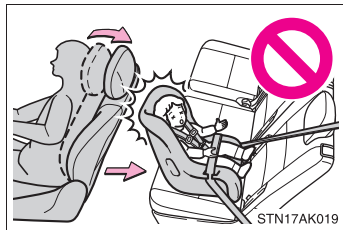

- If the driver's seat interferes with the child restraint system and prevents it from being attached correctly, attach the child restraint system to the right-hand rear seat (left-hand drive vehicles) or the left-hand rear seat (right-hand drive vehicles).
- Adjust the front passenger seat so that it does not interfere with the child restraint system.
- Child restraint system installed on the third seat should not contact the second seatbacks.
- When installing a forward-facing child or junior seat on the front passenger seat, move the seat as far back as possible. Failing to do so may result in death or serious injury if the airbags deploy (inflate).

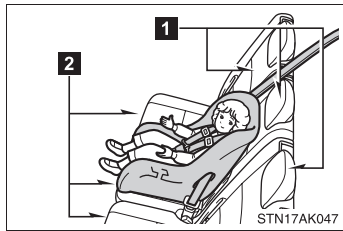
⚠ CAUTION**■ When installing a child restraint system**

- When installing a child restraint system in the rear seat, adjust the adjacent seat cushions to the same position (second seats) and align seatbacks at the same angle. Otherwise, the child restraint system cannot be securely restrained and this may cause death or serious injuries in the event of sudden braking, sudden swerving or an accident.

1 Same angle

2 Same position (second seats)

- Never use a rear-facing child restraint system on the front passenger seat when the airbag manual on-off switch is "ON". (→P. 178)

The force of the rapid inflation of the front passenger airbag can cause death or serious injury to children in the event of an accident.

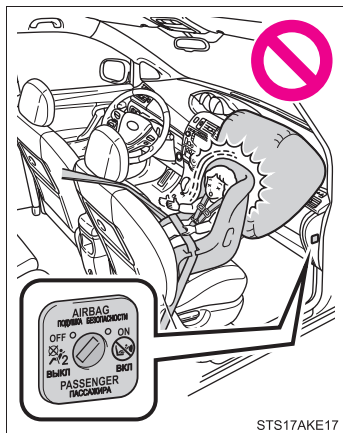

1

Before driving

⚠ CAUTION

■ **When installing a child restraint system**

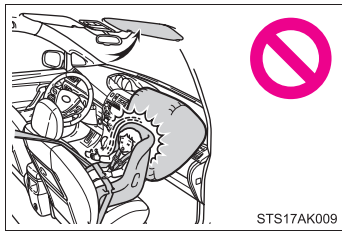

- There is a label(s) on the passenger side sun visor, indicating it is forbidden to attach a rear-facing child restraint system to the front passenger seat.

Details of the label(s) are shown in the illustration below.



- If child restraint system regulations exist in the country where you reside, please contact any authorized Toyota dealer or repairer, or another duly qualified and equipped professional for the child restraint system installation.
- When a junior seat is installed, always ensure that the shoulder belt is positioned across the center of the child's shoulder. The belt should be kept away from the child's neck, but not so that it could fall off the child's shoulder. Failing to do so may result in death or serious injury in the event of sudden braking, sudden swerving or an accident.
- Ensure that the belt and tab are securely locked and the seat belt is not twisted.

 CAUTION

- Shake the child restraint system left and right, and forward and backward to ensure that it has been securely installed.
- Follow all installation instructions provided by the child restraint system manufacturer.

■ **To correctly attach a child restraint system to the anchors**

When using the lower anchors, be sure that there are no foreign objects around the anchors and that the seat belt is not caught behind the child restraint system. Make sure the child restraint system is securely attached, or it may cause death or serious injury to the child or other passengers in the event of a sudden stop, sudden swerve or accident.

1

Before driving

1-7. Safety information

Airbag manual on-off system

This system deactivates the front passenger airbag.
Only deactivate the airbags when using a child restraint system on the front passenger seat.

► Vehicles with manual air conditioning system

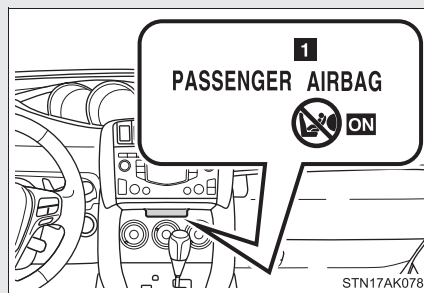

1 “PASSENGER AIRBAG” indicator

Vehicles without smart entry & start system: This indicator light turns on when the airbag system is on (only when the engine switch is in the “ON” position).

Vehicles with smart entry & start system: This indicator light turns on when the airbag system is on (only when the “ENGINE START STOP” switch is in IGNITION ON mode).

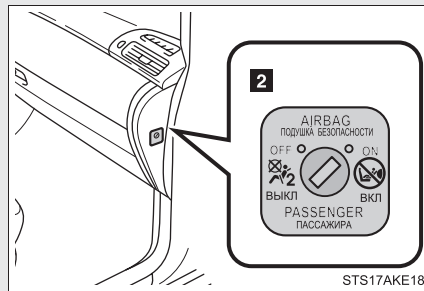

2 Airbag manual on-off switch

► Vehicles with automatic air conditioning system

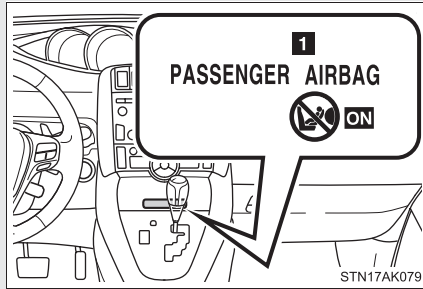

1 “PASSENGER AIRBAG” indicator

Vehicles without smart entry & start system: This indicator light turns on when the airbag system is on (only when the engine switch is in the “ON” position).

Vehicles with smart entry & start system: This indicator light turns on when the airbag system is on (only when the “ENGINE START STOP” switch is in IGNITION ON mode).

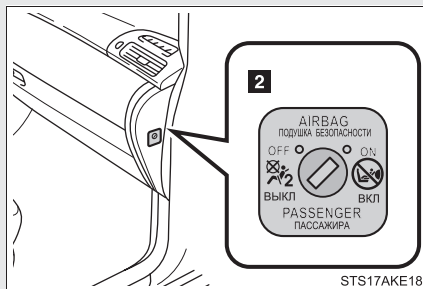

2 Airbag manual on-off switch

1

Before driving

Deactivating the front passenger airbag

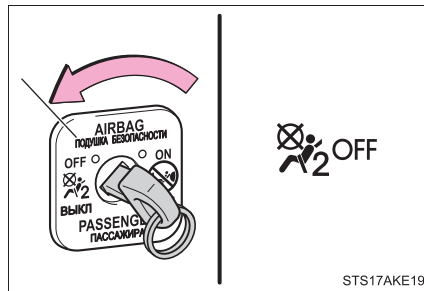

Vehicles without smart entry & start system: Insert the key into the cylinder and turn to the “OFF” position.

The “OFF” indicator light turns on (only when the engine switch is in the “ON” position).

Vehicles with smart entry & start system: Insert the mechanical key into the cylinder and rotate to the “OFF” position.

The “OFF” indicator light turns on (only when the “ENGINE START STOP” switch is in IGNITION ON mode).

■ “PASSENGER AIRBAG” indicator information

If any of the following problems occurs, it is possible that there is a malfunction in the system. Have the vehicle inspected by any authorized Toyota dealer or repairer, or another duly qualified and equipped professional.

- Neither “ON” nor “OFF” comes on.
- The indicator does not change when the airbag manual on-off switch is switched to the “ON” or “OFF” position.

⚠ CAUTION**■ When installing a child restraint system**

For safety reasons, always install the child restraint system in a rear seat. In the event that the rear seat cannot be used, the front seat can be used as long as the airbag manual on-off system is set to "OFF".

If the airbag manual on-off system is left "ON", the strong impact of the airbag deployment (inflation) may cause serious injury or even death.

■ When a child restraint system is not installed on the front passenger seat

Ensure that the airbag manual on-off system is set to "ON".

If it is left "OFF", the airbag may not deploy in the event of an accident, which may result in serious injury or even death.

1

Before driving

1-7. Safety information

2-1. Driving procedures

Driving the vehicle 184
 Engine (ignition) switch
 (vehicles without smart
 entry & start system)..... 198
 Engine (ignition) switch
 (vehicles with smart
 entry & start system)..... 202
 Multidrive 208
 Manual transmission..... 214
 Turn signal lever 218
 Parking brake 219
 Horn..... 221

2-2. Instrument cluster

Gauges and meters 222
 Indicators and warning
 lights 227
 Multi-information display... 232

2-3. Operating the lights and wipers

Headlight switch 244
 Fog light switch..... 251
 Windshield wipers and
 washer 252
 Rear window wiper and
 washer 257

2-4. Using other driving systems

Cruise control..... 258
 Speed limiter..... 262
 Toyota parking
 assist-sensor 265
 Stop & Start system 273
 Driving assist systems 280

2-5. Driving information

Cargo and luggage 286
 Winter driving tips 289
 Trailer towing 293

2-1. Driving procedures

Driving the vehicle

The following procedures should be observed to ensure safe driving.

■ Starting the engine (→P. 198, 202)

■ Driving

▶ Multidrive

STEP 1 With the brake pedal depressed, shift the shift lever to “D” or “M”. (→P. 208)

STEP 2 Release the parking brake. (→P. 219)

STEP 3 Gradually release the brake pedal and gently depress the accelerator pedal to accelerate the vehicle.

▶ Manual transmission

STEP 1 With the clutch pedal fully depressed, shift the shift lever to “1”. (→P. 214)

STEP 2 Release the parking brake. (→P. 219)

STEP 3 Gradually release the clutch pedal. At the same time, gently depress the accelerator pedal to accelerate the vehicle.

■ Stopping

▶ Multidrive

STEP 1 With the shift lever in “D” or “M”, depress the brake pedal.

STEP 2 If necessary, set the parking brake.

When the vehicle is stopped for an extended period of time, shift the shift lever to “P” or “N”. (→P. 208)

▶ Manual transmission

STEP 1 With the clutch pedal fully depressed, depress the brake pedal.

STEP 2 If necessary, set the parking brake.

When the vehicle is stopped for an extended period of time, shift the shift lever to “N”. (→P. 214)

■ Parking the vehicle

▶ Multidrive

STEP 1 With the shift lever in “D” or “M”, depress the brake pedal.

STEP 2 Set the parking brake. (→P. 219)

STEP 3 Shift the shift lever to “P”. (→P. 208)

When parking on a hill, if necessary, block the wheels.

STEP 4 Vehicles without smart entry & start system: Turn the engine switch to the “LOCK” position and stop the engine.
Vehicles with smart entry & start system: Turn the “ENGINE START STOP” switch off and stop the engine.

STEP 5 Lock the door, making sure that you have the key on your person.

▶ Manual transmission

STEP 1 With the clutch pedal fully depressed, depress the brake pedal.

STEP 2 Set the parking brake. (→P. 219)

STEP 3 Shift the shift lever to “N”. (→P. 214)

When parking on a hill, shift the shift lever to “1” or “R”. If necessary, block the wheels.

STEP 4 Vehicles without smart entry & start system: Turn the engine switch to the “LOCK” position and stop the engine.
Vehicles with smart entry & start system: Turn the “ENGINE START STOP” switch off and stop the engine.

STEP 5 Lock the door, making sure that you have the key on your person.

Starting on a steep uphill

► Multidrive

STEP 1 Firmly set the parking brake and shift the shift lever to “D” or “M”.

STEP 2 Gently depress the accelerator pedal.

STEP 3 Release the parking brake.

► Manual transmission

STEP 1 With the parking brake set and the clutch pedal fully depressed, shift the shift lever to “1”.

STEP 2 Lightly depress the accelerator pedal at the same time as gradually releasing the clutch pedal.

STEP 3 Release the parking brake.

■ Hill-start assist control

The hill-start assist control allows you to smoothly start off the vehicle on a steep or slippery uphill incline. (→P. 280)

■ Driving in the rain

- Drive carefully when it is raining, because visibility will be reduced, the windows may become fogged-up, and the road will be slippery.
- Drive carefully when it starts to rain, because the road surface will be especially slippery.
- Refrain from high speeds when driving on an expressway in the rain, because there may be a layer of water between the tires and the road surface, preventing the steering and brakes from operating properly.

■ Engine speed while driving (vehicles with a Multidrive)

In the following conditions, the engine speed may become high while driving. This is due to automatic up-shifting control or down-shifting implementation to meet driving conditions. It does not indicate sudden acceleration.

- The vehicle is judged to be driving uphill or downhill
- When the accelerator pedal is released
- When the brake pedal is depressed while “SPORT” mode is selected

■ Breaking in your new Toyota

To extend the life of the vehicle, the following precautions are recommended to observe:

- For the first 300 km (200 miles):
Avoid sudden stops.
- For the first 800 km (500 miles):
Do not tow a trailer.
- For the first 1000 km (600 miles):
 - Do not drive at extremely high speeds.
 - Avoid sudden acceleration.
 - Do not drive continuously in the low gears.
 - Do not drive at a constant speed for extended periods.

■ Drum-in-disc type parking brake system

Your vehicle has a drum-in-disc type parking brake system. This type of brake system needs bedding-down of the brake shoes periodically or whenever the parking brake shoes and/or drum are replaced. Have any authorized Toyota dealer or repairer, or another duly qualified and equipped professional, perform the bedding down.

■ **Eco-friendly driving (if equipped)**

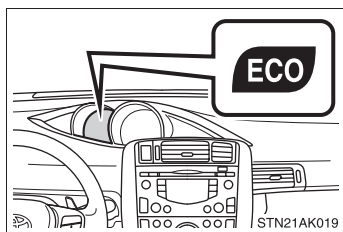

During Eco-friendly acceleration (Eco driving), Eco Driving Indicator Light will turn on. When the acceleration exceeds Zone of Eco driving, and when the vehicle is stopped, the light turns off.

Eco Driving Indicator Light will not operate in any of the following conditions:

- The shift lever is in anything other than “D”.
- The driving mode is set to “SPORT” mode. (→P. 209)
- The paddle shift switch is operated while the shift lever is in “D”.
- The vehicle speed is approximately 130 km/h (80 mph) or higher.

Eco Driving Indicator Light can be activated or deactivated. (→P. 240)

■ **Idling time before engine stop (diesel engine only)**

To prevent damage to the turbocharger, allow the engine to idle immediately after high-speed driving or hill climbing.

Driving condition		Idling time
Normal city driving		Not necessary
High-speed driving	Constant speed of approx. 80 km/h (50 mph)	Approximately 20 seconds
	Constant speed of approx. 100 km/h (62 mph)	Approximately 1 minute
Steep hill driving or continuous driving at 100 km/h (62 mph) or more (race track driving etc.)		Approximately 2 minutes

■ **Operating your vehicle in a foreign country**

Comply with the relevant vehicle registration laws and confirm the availability of the correct fuel. (→P. 583)

⚠ CAUTION**■ When starting the vehicle (vehicles with a Multidrive)**

Always keep your foot on the brake pedal while stopped with the engine running. This prevents the vehicle from creeping.

■ When driving the vehicle

- Do not drive if you are unfamiliar with the location of the brake and accelerator pedals to avoid depressing the wrong pedal.
 - Accidentally depressing the accelerator pedal instead of the brake pedal will result in sudden acceleration that may lead to an accident that could result in death or serious injury.
 - When backing up, you may twist your body around, leading to a difficulty in operating the pedals. Make sure to operate the pedals properly.
 - Make sure to keep a correct driving posture even when moving the vehicle only slightly, allowing you to depress the brake and accelerator pedals properly.
 - Depress the brake pedal using your right foot. Depressing the brake pedal using your left foot may delay response in an emergency, resulting in an accident.
- Do not drive the vehicle over or stop the vehicle near flammable materials. The exhaust system and exhaust gases can be extremely hot. This may cause a fire if there is any flammable material nearby.
- On vehicles with a Multidrive, do not let the vehicle roll backwards while the shift lever is in a driving position, or roll forward while the shift lever is in "R".
Doing so may cause the engine to stall or lead to poor brake and steering performance, resulting in an accident or damage to the vehicle.
- If the smell of exhaust is noticed inside the vehicle, open the windows and check that the back door is closed.
Large amounts of exhaust in the vehicle can cause driver drowsiness and an accident, resulting in death or a serious health hazard. Have the vehicle inspected by any authorized Toyota dealer or repairer, or another duly qualified and equipped professional immediately.

 CAUTION

■ **When driving the vehicle**

- On vehicles with a Multidrive, do not shift the shift lever to “P” while the vehicle is moving.
Doing so can damage the transmission and may result in a loss of vehicle control.
- Do not shift the shift lever to “R” while the vehicle is moving forward.
Doing so can damage the transmission and may result in a loss of vehicle control.
- Do not shift the shift lever to a driving position while the vehicle is moving backward.
Doing so can damage the transmission and may result in a loss of vehicle control.
- Moving the shift lever to “N” while the vehicle is moving will disengage the engine from the transmission. Engine braking is not available when “N” is selected.
- During normal driving, do not turn off the engine. Turning the engine off while driving will not cause loss of steering or braking control, but the power assist to these systems will be lost. This will make it more difficult to steer and brake, so you should pull over and stop the vehicle as soon as it is safe to do so.
However, in the event of an emergency, such as if it becomes impossible to stop the vehicle in the normal way: →P. 574
- Use engine braking (downshift) to maintain a safe speed when driving down a steep hill.
Using the brakes continuously may cause the brakes to overheat and lose effectiveness. (→P. 208, 214)
- When stopped on an inclined surface, use the brake pedal and parking brake to prevent the vehicle from rolling backward or forward and causing an accident.
- Do not adjust the position of the steering wheel, the seat, or the inside or outside rear view mirrors while driving.
Doing so may result in a loss of vehicle control that can cause accidents that may result in death or serious injury.

⚠ CAUTION**■ When driving the vehicle**

- Always check that all passengers' arms, heads or other parts of their bodies are not outside the vehicle, as this may result in death or serious injury.

■ When driving on slippery road surfaces

- Sudden braking, acceleration and steering may cause tire slippage and reduce your ability to control the vehicle, resulting in an accident.
- Sudden acceleration, engine braking due to shifting, or changes in engine speed could cause the vehicle to skid, resulting in an accident.
- After driving through a puddle, lightly depress the brake pedal to make sure that the brakes are functioning properly. Wet brake pads may prevent the brakes from functioning properly. If the brakes on only one side are wet and not functioning properly, steering control may be affected, resulting in an accident.

■ When shifting the shift lever (vehicles with a Multidrive)

Be careful not to shift the shift lever with the accelerator pedal depressed. This may lead to unexpected rapid acceleration of the vehicle that may cause an accident and result in death or serious injury.

■ When the vehicle is stopped

- Do not race the engine.
If the vehicle is in any shift positions other than "P" (Multidrive) or "N", the vehicle may accelerate suddenly and unexpectedly, and may cause an accident.
- Do not leave the vehicle with the engine running for a long time.
If such a situation cannot be avoided, park the vehicle in an open space and check that exhaust fumes do not enter the vehicle interior.
- On vehicles with a Multidrive, in order to prevent accidents due to the vehicle rolling away, always keep depressing the brake pedal while the engine is running, and apply the parking brake as necessary.
- If the vehicle is stopped on an incline, in order to prevent accidents caused by the vehicle rolling forward or backward, always depress the brake pedal and securely apply the parking brake as needed.

 CAUTION

■ **When the vehicle is stopped**

- Avoid revving or racing the engine. Running the engine at high speed while the vehicle is stopped may cause the exhaust system to overheat, which could result in a fire if combustible material is nearby.

■ **When the vehicle is parked**

- Do not leave glasses, cigarette lighters, spray cans, or soft drink cans in the vehicle when it is in the sun.

Doing so may result in the following:

- Gas may leak from a cigarette lighter or spray can, and may lead to a fire.
 - The temperature inside the vehicle may cause the plastic lenses and plastic material of eye glasses to deform or crack.
 - Soft drink cans may rupture, causing the contents to spray over the interior of the vehicle, and may also cause a short circuit in the vehicle's electrical components.
- Always apply the parking brake, shift the shift lever to "P" (Multidrive), stop the engine and lock the vehicle.
Do not leave the vehicle unattended while the engine is running.
 - Do not touch the exhaust pipe while the engine is running or immediately after turning the engine off.
Doing so may cause burns.
 - Do not leave the engine running in an area with snow build up, or where it is snowing. If snowbanks build up around the vehicle while the engine is running, exhaust gases may collect and enter the vehicle. This may lead to death or a serious health hazard.

 CAUTION**■ Exhaust gases**

Exhaust gases include harmful carbon monoxide (CO) that is colorless and odorless. Inhaling exhaust gases may lead to death or a serious health hazard.

- If the vehicle is in a poorly ventilated area, stop the engine. In a closed area, such as a garage, exhaust gases may collect and enter the vehicle. This may lead to death or a serious health hazard.
- The exhaust should be checked occasionally. If there is a hole or crack caused by corrosion, damage to a joint or abnormal exhaust noise, be sure to have the vehicle inspected and repaired by any authorized Toyota dealer or repairer, or another duly qualified and equipped professional. Failure to do so may allow exhaust gases to enter the vehicle, resulting in death or a serious health hazard.

■ When taking a nap in the vehicle

Always turn the engine off.

Otherwise, you may accidentally move the shift lever or depress the accelerator pedal, which could cause an accident or fire due to engine overheating. Additionally, if the vehicle is parked in a poorly ventilated area, exhaust gases may collect and enter the vehicle, leading to death or a serious health hazard.

 CAUTION

■ **When braking the vehicle**

- When the brakes are wet, drive more cautiously.
Braking distance increases when the brakes are wet, and may cause one side of the vehicle to brake differently than the other side. Also, the parking brake may not securely hold the vehicle.
- If the power brake assist function does not operate, do not follow other vehicles closely and avoid hills or sharp turns that require braking.
In this case, braking is still possible, but the brake pedal should be depressed more firmly than usual. Also, the braking distance will increase. Have your brakes fixed immediately.
- Do not pump the brake pedal if the engine stalls.
Each push on the brake pedal uses up the reserve for the power-assisted brakes.
- The brake system consists of 2 individual hydraulic systems: If one of the systems fails, the other will still operate. In this case, the brake pedal should be depressed more firmly than usual and the braking distance will increase.
Have your brakes fixed immediately.

 NOTICE

■ When driving the vehicle
▶ Vehicles with a Multidrive

- Do not depress the accelerator and brake pedals at the same time during driving, as this may restrain driving torque.
- Do not use the accelerator pedal or depress the accelerator and brake pedals at the same time to hold the vehicle on a hill.

▶ Vehicles with a manual transmission

- Do not depress the accelerator and brake pedals at the same time during driving, as this may restrain driving torque.
- Do not shift gears unless the clutch pedal is fully depressed. After shifting, do not release the clutch pedal abruptly. Doing so may damage the clutch, transmission and gears.
- Observe the following to prevent the clutch from being damaged.
 - Do not rest your foot on the clutch pedal while driving. Doing so may cause clutch trouble.
 - Do not use any gears other than the 1st gear when starting off and moving forward. Doing so may damage the clutch.
 - Do not use the clutch to hold the vehicle when stopping on an uphill grade. Doing so may damage the clutch.
- Do not shift the shift lever to “R” when the vehicle is still moving. Doing so may damage the clutch, transmission and gears.

■ When parking the vehicle (vehicles with a Multidrive)

Always put the shift lever in “P”. Failure to do so may cause the vehicle to move or the vehicle may accelerate suddenly if the accelerator pedal is accidentally depressed.

 NOTICE

■ **Avoiding damage to vehicle parts**

- Do not turn the steering wheel fully in either direction and hold it there for an extended period of time.
Doing so may damage the power steering motor.
- When driving over bumps in the road, drive as slowly as possible to avoid damaging the wheels, underside of the vehicle, etc.
- Diesel engine only: Make sure to idle the engine immediately after high-speed driving or hill climbing. Stop the engine only after the turbocharger has cooled down.
Failure to do so may cause damage to the turbocharger.

■ **If you hear a squealing or scraping noise (brake pad wear indicators)**

Have the brake pads checked and replaced by any authorized Toyota dealer or repairer, or another duly qualified and equipped professional, as soon as possible.

The rotor damage can result if the pads are not replaced when needed.

It is dangerous to drive the vehicle when the wear limits of the brake pads and/or that of the brake discs are exceeded.

■ **If you get a flat tire while driving**

A flat or damaged tire may cause the following situations. Hold the steering wheel firmly and gradually press the brake pedal to slow down the vehicle.

- It may be difficult to control your vehicle.
- The vehicle will make abnormal sounds.
- The vehicle will behave abnormally.

Information on what to do in case of a flat tire. (→P. 522, 539)

 NOTICE**■ When encountering flooded roads**

Do not drive on a road that has flooded after heavy rain etc. Doing so may cause the following serious damage to the vehicle.

- Engine stalling
- Short in electrical components
- Engine damage caused by water immersion

In the event that you drive on a flooded road and the vehicle is flooded, be sure to have any authorized Toyota dealer or repairer, or another duly qualified and equipped professional check the following.

- Brake function
- Changes in quantity and quality of engine oil, transmission fluid, etc.
- Lubricant condition for the bearings and suspension joints (where possible) and the function of all joints, bearings, etc.

2-1. Driving procedures

Engine (ignition) switch (vehicles without smart entry & start system)

■ Starting the engine

▶ Multidrive

STEP 1 Check that the parking brake is set.

STEP 2 Check that the shift lever is set in "P".

STEP 3 Sit in the driver's seat and firmly depress the brake pedal.

STEP 4 Turn the engine switch to the "START" position and start the engine.

▶ Manual transmission (gasoline engine)

STEP 1 Check that the parking brake is set.

STEP 2 Check that the shift lever is set in "N".

STEP 3 Sit in the driver's seat and firmly depress the clutch pedal.

STEP 4 Turn the engine switch to the "START" position and start the engine.

▶ Manual transmission (diesel engine)

STEP 1 Check that the parking brake is set.

STEP 2 Check that the shift lever is set in "N".

STEP 3 Sit in the driver's seat and firmly depress the clutch pedal.

STEP 4 Turn the engine switch to the "ON" position.

 indicator light turns on.

STEP 5 After  indicator light goes out, turn the engine switch to the "START" position and start the engine.

■ Engine (ignition) switch

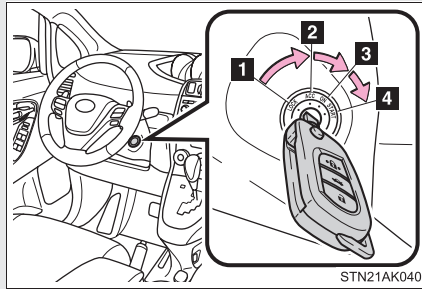

1 "LOCK"

The steering wheel is locked and the key can be removed. (Vehicles with a Multidrive: The key can be removed only when the shift lever is in "P".)

2 "ACC"

Some electrical components such as the audio system can be used.

3 "ON"

All electrical components can be used.

4 "START"

For starting the engine.

■ **When the steering lock cannot be released**

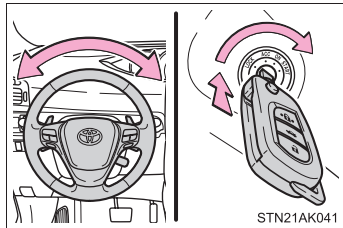

When starting the engine, the engine switch may seem stuck in the “LOCK” position. To free it, turn the key while turning the steering wheel slightly in either direction.

■ **If the engine does not start**

The engine immobilizer system may not have been deactivated. (→P. 124)
Contact any authorized Toyota dealer or repairer, or another duly qualified and equipped professional.

■ **Key reminder function**

A buzzer sounds if the driver’s door is opened, while the key is in the “LOCK” or “ACC” position to remind you to remove the key.

⚠ CAUTION

■ **When starting the engine**

Always start the engine while sitting in the driver’s seat. Do not press the accelerator pedal while starting the engine under any circumstances. Doing so may cause an accident resulting in death or serious injury.

■ **Caution while driving**

Do not turn the engine switch to the “LOCK” position.
If in an emergency, you must turn the engine off while the vehicle is moving, turn the engine switch only to the “ACC” position. (→P. 574)

 NOTICE

■ **To prevent battery discharge**

Do not leave the engine switch in the “ACC” or “ON” position for long periods if the engine is not the engine running.

■ **When starting the engine**

- Do not crank for more than 30 seconds at a time. This may overheat the starter and wiring systems.
- Do not race the cold engine.
- If the engine becomes difficult to start or stalls frequently, have your vehicle checked by any authorized Toyota dealer or repairer, or another duly qualified and equipped professional immediately.

2-1. Driving procedures

Engine (ignition) switch (vehicles with smart entry & start system)

Performing the following operations when carrying the electronic key on your person starts the engine or changes “ENGINE START STOP” modes.

■ Starting the engine

► Multidrive

STEP 1 Check that the parking brake is set.

STEP 2 Check that the shift lever is set in “P”.

STEP 3 Sit in the driver’s seat and firmly depress the brake pedal.

The “ENGINE START STOP” switch indicator turns green.

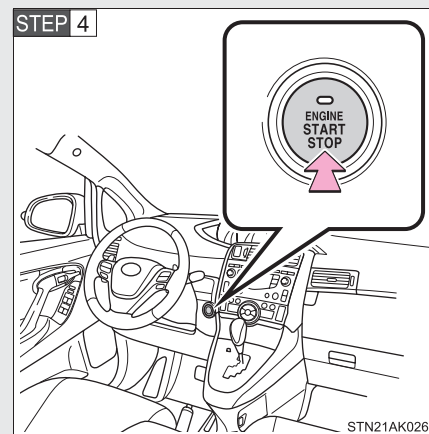

Press the “ENGINE START STOP” switch.

The engine can be started from any “ENGINE START STOP” switch mode.

Continue depressing the brake pedal until the engine is completely started. The engine will crank until it starts or for up to 30 seconds, whichever is less.

► Manual transmission

STEP 1 Check that the parking brake is set.

STEP 2 Check that the shift lever is set in “N”.

STEP 3 Sit in the driver’s seat and firmly depress the clutch pedal.

The “ENGINE START STOP” switch indicator turns green.

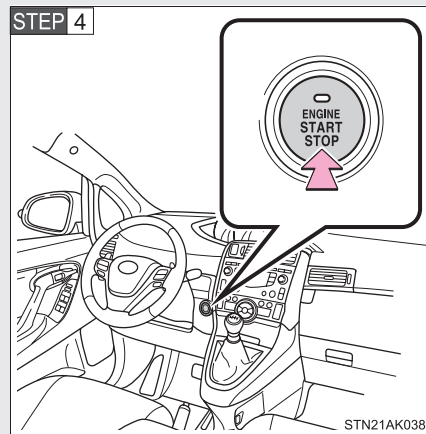

Press the “ENGINE START STOP” switch.

The engine can be started from any “ENGINE START STOP” switch mode.

Continue depressing the clutch pedal until the engine is completely started. The engine will crank until it starts or for up to 30 seconds, whichever is less.

Diesel engine only:  indicator turns on. The engine begins starting after the indicator light goes out.

■ Changing “ENGINE START STOP” switch mode

Modes can be changed by pressing the “ENGINE START STOP” switch with the brake pedal (Multidrive) or clutch pedal (manual transmission) released. (The mode changes each time the switch is pressed.)

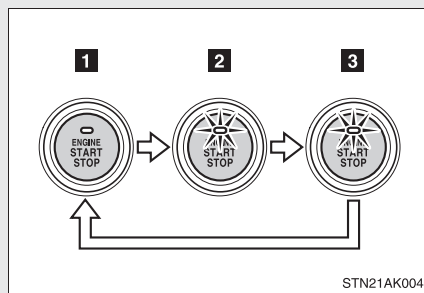

1 Off*

Emergency flashers can be used.

2 ACCESSORY mode

Some electrical components such as the audio system can be used.

The “ENGINE START STOP” switch indicator turns orange.

3 IGNITION ON mode

All electrical components can be used.

The “ENGINE START STOP” switch indicator turns orange.

*: For vehicles with a Multidrive, if the shift lever is in a position other than “P” when turning off the engine, the “ENGINE START STOP” switch will be turned to ACCESSORY mode, not to off.

■ If the engine does not start

The engine immobilizer system may not have been deactivated. (→P. 124)
Contact any authorized Toyota dealer or repairer, or another duly qualified and equipped professional.

■ Steering lock

When the “ENGINE START STOP” switch is turned off and then a door is opened and closed, the steering lock function locks the steering wheel in its current position. The steering lock is disabled when the “ENGINE START STOP” switch is operated again.

■ When the steering lock cannot be released

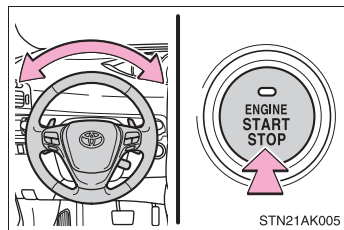

The green indicator light on the “ENGINE START STOP” switch will flash and a message will be shown on the multi-information display. To free it, press the “ENGINE START STOP” switch while turning the steering wheel slightly in either direction.

■ Steering lock motor overheating prevention

If the engine is started and stopped repeatedly in a short time, operation of the steering lock motor is restricted to prevent overheating. If this occurs, wait momentarily without operating the “ENGINE START STOP” switch. The system will return to its normal condition in approximately 10 seconds.

■ When the “ENGINE START STOP” switch indicator flashes in orange

The system may be malfunctioning. Have the vehicle inspected by any authorized Toyota dealer or repairer, or another duly qualified and equipped professional immediately.

■ **Auto power off function**

▶ Vehicles with a Multidrive

If the vehicle is left in ACCESSORY mode for more than 20 minutes with the shift lever in “P”, the “ENGINE START STOP” switch will automatically turn off.

▶ Vehicles with a manual transmission

If the vehicle is left in ACCESSORY mode for more than 20 minutes, the “ENGINE START STOP” switch will automatically turn off.

■ **“ENGINE START STOP” switch operation**

When operating the “ENGINE START STOP” switch, push it quickly and firmly. If the switch is not pushed firmly, the mode may not change or the engine may not start. Furthermore, if the switch is pushed quickly and firmly, there is no need to hold it down.

■ **Electronic key battery depletion**

→P. 47

■ **When the electronic key battery is discharged**

→P. 562

■ **Conditions affecting operation**

→P. 63

■ **Note for the smart entry & start system**

→P. 47

 **CAUTION**

■ **When starting the engine**

Always start the engine while sitting in the driver’s seat. Do not depress the accelerator pedal while starting the engine under any circumstances. Doing so may cause an accident resulting in death or serious injury.

⚠ CAUTION**■ Caution while driving**

If the vehicle is coasting without engine power, for example if the engine stalls, do not open a door or operate the locks until the vehicle is completely stopped in a safe condition. Driving with the steering locked may cause an accident, resulting in death or serious injury.

■ Stopping the engine in an emergency

If you want to stop the engine in an emergency while driving the vehicle, press and hold the “ENGINE START STOP” switch for more than 2 seconds, or press it briefly 3 times or more in succession. (→P. 574)

However, do not touch the “ENGINE START STOP” switch while driving except in an emergency. Turning the engine off while driving will not cause loss of steering or braking control, but the power assist to these systems will be lost. This will make it more difficult to steer and brake, so you should pull over and stop the vehicle as soon as it is safe to do so.

2

When driving

⚠ NOTICE**■ To prevent battery discharge**

Do not leave the “ENGINE START STOP” switch in ACCESSORY or IGNITION ON mode for long periods without the engine running.

■ When starting the engine

- Do not race a cold engine.
- If the engine becomes difficult to start or stalls frequently, have your vehicle checked by any authorized Toyota dealer or repairer, or another duly qualified and equipped professional immediately.

■ “ENGINE START STOP” switch operation

If you feel something catching or sense irregular resistance when operating the “ENGINE START STOP” switch, then there may be a malfunction. Immediately contact any authorized Toyota dealer or repairer, or another duly qualified and equipped professional.

2-1. Driving procedures

Multidrive*

Select a shift position appropriate for the driving conditions.

■ Shifting the shift lever

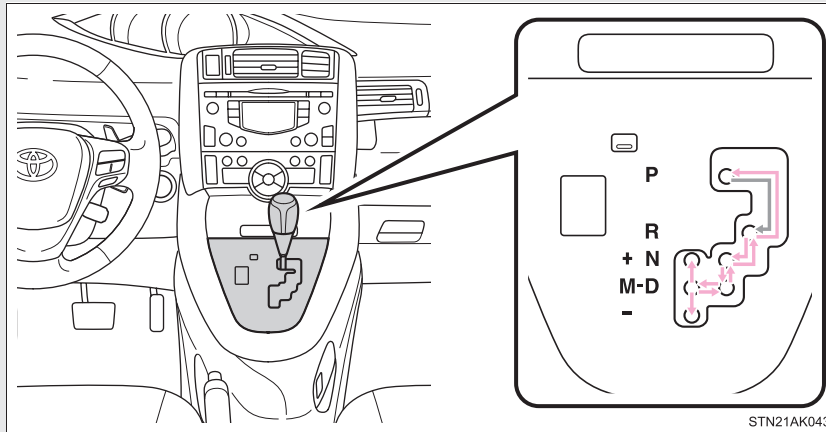

▶ Vehicles without smart entry & start system

While the engine switch is in the “ON” position, move the shift lever with the brake pedal depressed.

When shifting the shift lever between “P” and “D”, make sure that the vehicle is completely stopped.

▶ Vehicles with smart entry & start system

While the “ENGINE START STOP” switch is in IGNITION ON mode, move the shift lever with the brake pedal depressed.

When shifting the shift lever between “P” and “D”, make sure that the vehicle is completely stopped.

*: If equipped

■ Selecting a shift position

Shift position	Function
P	Parking the vehicle or starting the engine
R	Reversing
N	Neutral
D	Normal driving ^{*1} or temporary gear step selection driving ^{*2}
M	7-speed sport sequential shiftmatic mode driving (→P. 211)

^{*1}: To improve fuel consumption and reduce noises, set the shift lever in the “D” position for normal driving.

^{*2}: By selecting gear step using paddle shift switches, you can control engine braking forces.

■ Selecting a driving mode

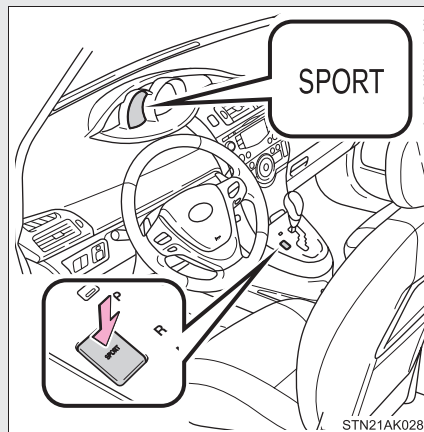

Press the switch.

For powerful acceleration and driving in mountainous regions.

Press the switch once more to return the normal mode.

Driving in the “D” position

■ Shift lever

If the shift lever is shifted into the “D” position, the appropriate gear ratio is automatically selected, as determined by the driving conditions.

■ Paddle shift switches

While the shift lever is in the “D” position, engine braking force can be temporarily switched to.

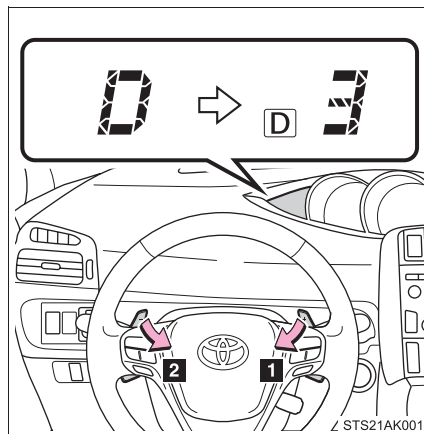

1 Upshifting

2 Downshifting

Unless the paddle shift switches are operated, the gear step displayed on the meter cluster is fixed.

However, even when in the “D” position, the gear steps will be automatically changed if the engine speed is too high, or too low.

Driving in the “M” position

By shifting the shift lever into the “M” position, 7 stages of gear step can be switched between.

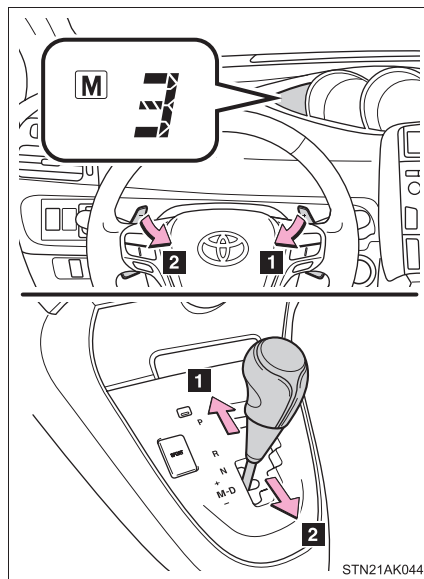

1 Upshifting

2 Downshifting

Unless the shift lever or paddle shift switches are operated, the gear step displayed on the meter cluster is fixed.

2

When driving

However, even when in the “M” position, the gear steps will be automatically changed if the engine speed is too high, or too low.

■ **Paddle shift switch**

- When the paddle shift switch is operated in the “D” position, a gear step will be automatically selected according to the vehicle speed and driving conditions.
- Automatic deactivation of gear step selection in the “D” position.
Gear step selection in the “D” position will be deactivated in the following situations:
 - The “+” paddle shift switch is held down for a period of time
 - When the vehicle comes to a stop
 - If the accelerator pedal is depressed for longer than a certain period of time in one gear step

■ **Downshifting restrictions warning buzzer**

To help ensure safety and driving performance, downshifting operation may sometimes be restricted. In some circumstances, downshifting may not be possible even when the shift lever or paddle shift switches are operated. (The warning buzzer will sound twice.)

■ **When driving with cruise control activated (if equipped)**

Even when performing the following actions with the intent of enabling engine braking, engine braking will not activate because cruise control will not be canceled.

- While driving in “D” or 7-speed sport sequential shiftmatic mode, downshifting to “6”, “5” or “4”. (→P. 210, 211)
- When switching the driving mode to “SPORT” mode while driving in “D” position. (→P. 209)

■ Automatic deactivation of “SPORT” mode**▶ Vehicles without smart entry & start system**

If the engine switch is turned to the “LOCK” position after driving in “SPORT” mode, the mode is automatically deactivated.

▶ Vehicles with smart entry & start system

If the “ENGINE START STOP” switch is turned off after driving in “SPORT” mode, the mode is automatically deactivated.

■ If the shift lever cannot be shifted from “P”

→P. 559

■ If the “M” indicator is not displayed after shifting the shift lever to the “M” position

If the display does not change to “M” on an occasion other than that described above, it may indicate a malfunction in the transmission system. Have your vehicle inspected by any authorized Toyota dealer or repairer, or another duly qualified and equipped professional immediately.

■ Automatic gear step selection

When the vehicle comes to a stop, the transmission will automatically down-shift to allow you to start off in 1st step.

2-1. Driving procedures

Manual transmission*

■ Shifting the shift lever

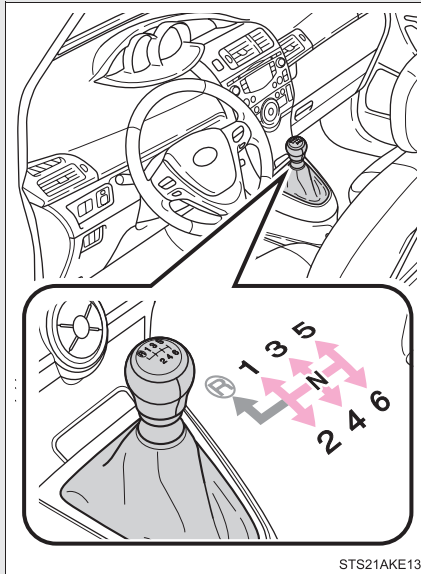

Fully depress the clutch pedal before operating the shift lever, and then release it slowly.

■ Shifting the shift lever to “R”

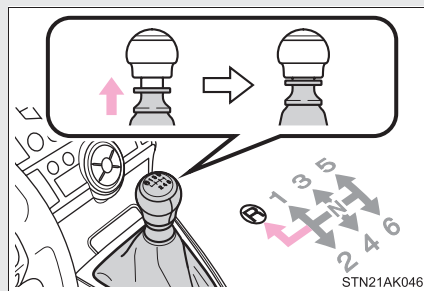

Shift the shift lever to the “R” position while lifting up the ring section.

*: If equipped

Gear Shift Indicator

Gear Shift Indicator is a guide to help the driver achieve improved fuel economy and reduced exhaust emissions within limits of engine performance.

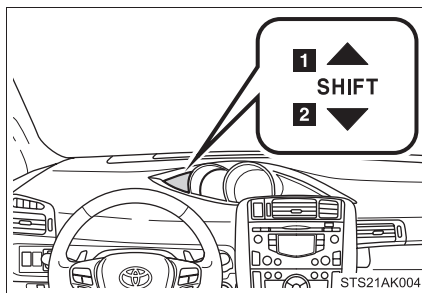

- 1 Upshifting
- 2 Downshifting

2

When driving

■ Gear Shift Indicator display

Gear Shift Indicator may not be displayed when your foot is placed on the clutch pedal.

2-1. Driving procedures

■ Maximum allowable speeds

Observe the following maximum allowable speeds in each gear when maximum acceleration is necessary.

▶ Gasoline engine

km/h (mph)

Shift position	Maximum speed
1	48 (30)
2	89 (55)
3	122 (76)
4	165 (103)

▶ Diesel engine

km/h (mph)

Shift position	Maximum speed
1	40 (25)
2	81 (50)
3	127 (79)
4	180 (112)

⚠ CAUTION

■ Gear Shift Indicator display

For safety, the driver should not look only at the display. Refer to the display when it is safe to do so while considering actual traffic and road conditions. Failure to do so may lead to an accident.

 NOTICE

■ To prevent damage to the transmission

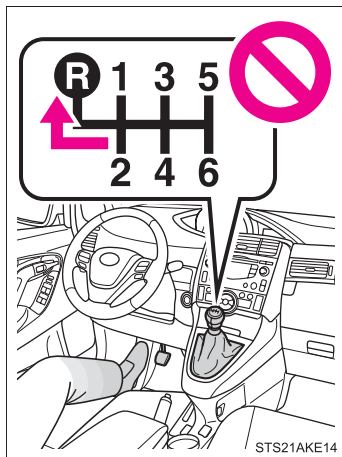

- Do not shift the shift lever to “R” without depressing the clutch pedal.

- Do not lift up the ring section except when shifting the lever to “R”.
- Shift the shift lever to “R” only when the vehicle is stationary.

2-1. Driving procedures

Turn signal lever

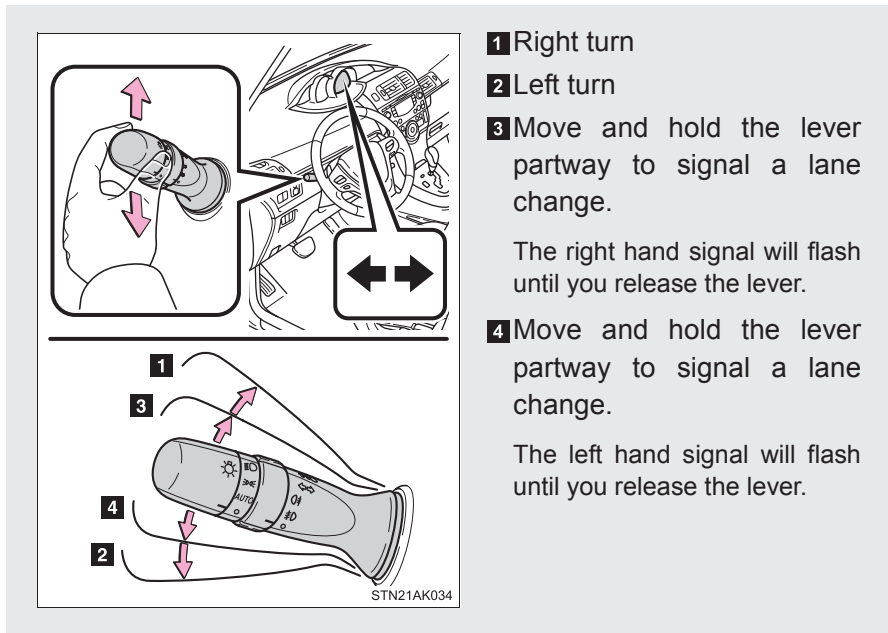

- 1 Right turn
- 2 Left turn
- 3 Move and hold the lever partway to signal a lane change.
The right hand signal will flash until you release the lever.
- 4 Move and hold the lever partway to signal a lane change.
The left hand signal will flash until you release the lever.

■ Turn signals can be operated when

- ▶ Vehicles without smart entry & start system

The engine switch is in the "ON" position.

- ▶ Vehicles with smart entry & start system

The "ENGINE START STOP" switch is in IGNITION ON mode.

■ If the indicators flash faster than usual

Check that a light bulb in the front or rear turn signal lights has not burned out.

2-1. Driving procedures

Parking brake

■ Set the parking brake

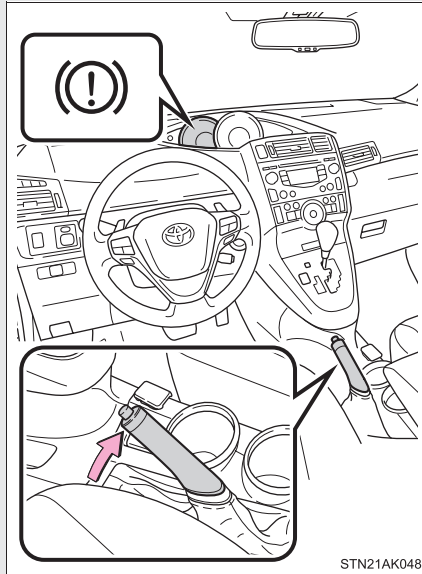

Fully set the parking brake while depressing the brake pedal.

At this time, the indicator will come on.

■ Release the parking brake

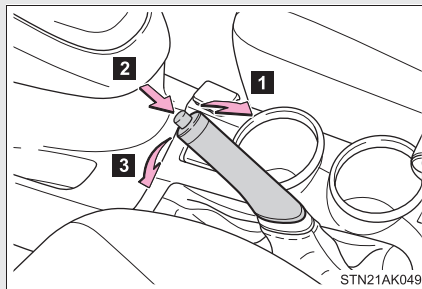

- 1 Slightly raise the lever
- 2 Press the button
- 3 Lower it completely

2

When driving

■ **Usage in winter time**

→P. 289

 **NOTICE**

■ **Before driving**

Fully release the parking brake.

Driving the vehicle with the parking brake set will lead to brake components overheating, which may affect braking performance and increase brake wear.

2-1. Driving procedures

Horn

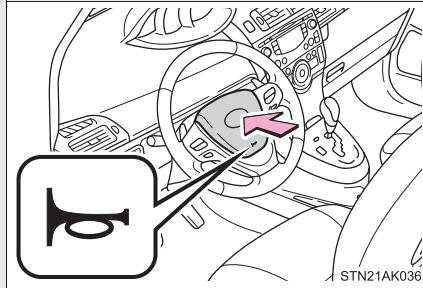

To sound the horn, press on or close to the  mark.

■ After adjusting the steering wheel

Make sure that the steering wheel is securely locked.

The horn may not sound if the steering wheel is not securely locked.
(→P. 104)

2

When driving

2-2. Instrument cluster Gauges and meters

► Left-hand drive vehicles

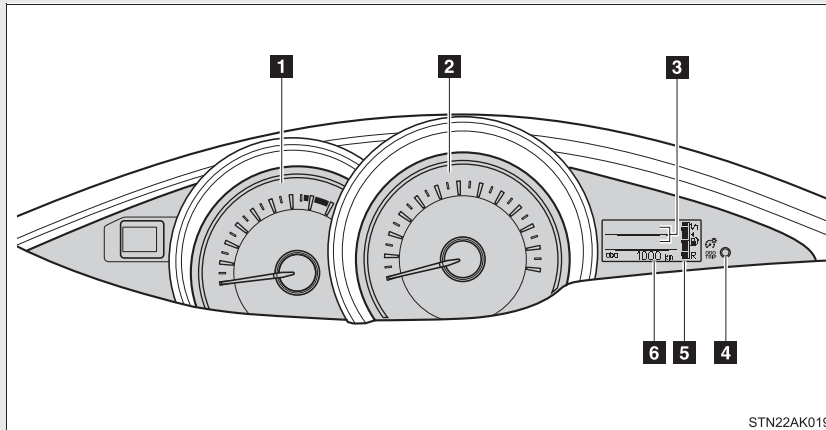

► Vehicles without smart entry & start system

The following gauges, meters and displays illuminate when the engine switch is in the “ON” position.

► Vehicles with smart entry & start system

The following gauges, meters and displays illuminate when the “ENGINE START STOP” switch is in IGNITION ON mode.

1 Tachometer

Displays the engine speed in revolutions per minute

2 Speedometer

Displays the vehicle speed

3 Multi-information display

Presents the driver with a variety of driving-related data (→P. 232)

4 Display change button

→P. 224

5 Fuel gauge

Displays the quantity of fuel remaining in the tank

- 6** Odometer, trip meter, Stop & Start system operation time, Stop & Start system total operation time, maintenance required information and instrument cluster light control display

→P. 224

- ▶ Right-hand drive vehicles

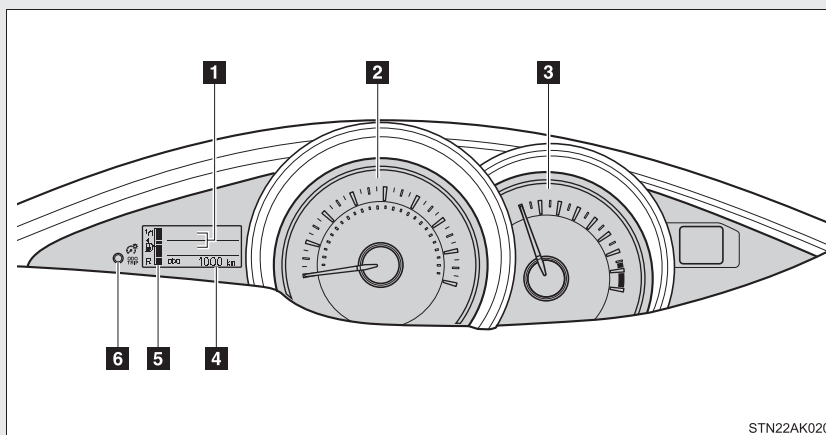

- ▶ Vehicles without smart entry & start system

The following gauges, meters and displays illuminate when the engine switch is in the “ON” position.

- ▶ Vehicles with smart entry & start system

The following gauges, meters and displays illuminate when the “ENGINE START STOP” switch is in IGNITION ON mode.

- 1** Multi-information display

Presents the driver with a variety of driving-related data (→P. 232)

- 2** Speedometer

Displays the vehicle speed

- 3** Tachometer

Displays the engine speed in revolutions per minute

2

When driving

4 Odometer, trip meter, Stop & Start system operation time, Stop & Start system total operation time, maintenance required information and instrument cluster light control display

→P. 224

5 Fuel gauge

Displays the quantity of fuel remaining in the tank

6 Display change button

→P. 224

Changing the display

Items displayed can be switched by pressing the button.

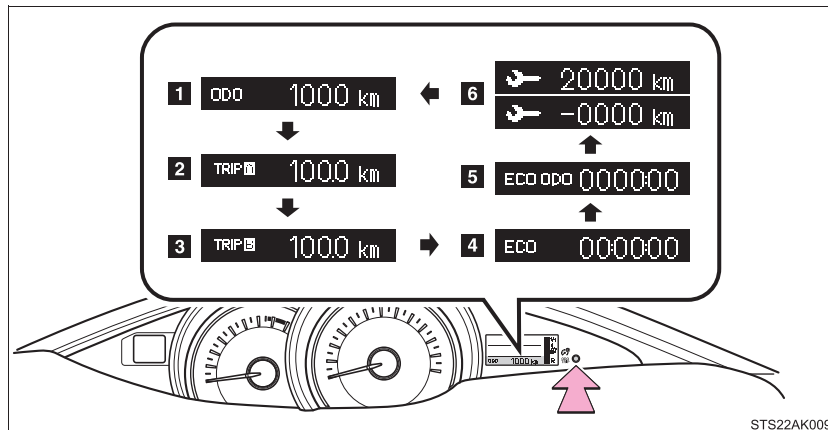

1 Odometer

Displays the total distance the vehicle has been driven.

2 Trip meter A

Displays the distance the vehicle has been driven since the meter was last reset.

Pressing and holding the button will reset.

3 Trip meter B

Displays the distance the vehicle has been driven since the meter was last reset.

Press and hold the button will reset.

4 Stop & Start system operation time (if equipped)

Displays the amount of time the engine was stopped due to operation of the Stop & Start system during the current trip.

Vehicles without smart entry & start system:

From the engine switch in the "ON" position to the engine switch in the "LOCK" position.

Vehicles with smart entry & start system:

From the "ENGINE START STOP" switch in IGNITION ON mode to the "ENGINE START STOP" switch off.

5 Stop & Start system total operation time (if equipped)

Displays the total amount of time that the engine has been stopped due to operation of the Stop & Start system since the system was last reset.

6 Maintenance required information (diesel engine only)

Displays the remaining distance until the engine oil should be changed. If "-" is displayed before distance, it means oil maintenance is overdue. Have the engine oil changed by any authorized Toyota dealer or repairer, or another duly qualified and equipped professional.

- Displays the Maintenance required information when the engine switch is turned to the "ON" position (vehicles without smart entry & start system) or the "ENGINE START STOP" is switched to IGNITION ON mode (vehicles with smart entry & start system).
- Maintenance required information reset method (→P. 420).

Instrument cluster light control

The brightness of the instrument cluster lights, for when the headlight switch is on, can be adjusted 5 brightness levels.

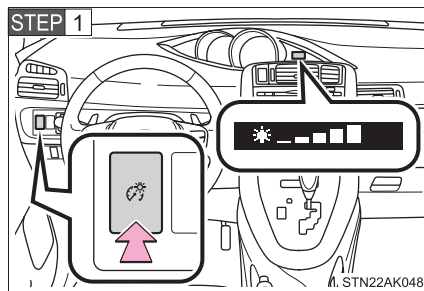

Press the instrument cluster light control switch.

The instrument cluster brightness changes each time the switch is pressed. To quickly change between the brightest level and previous condition, press and hold the switch.

STEP 2 The illumination level will be set automatically 10 seconds after the switch was last pressed.

Pressing the display change button before the 10 seconds have passed will also set the illumination level.

NOTICE

■ To prevent damage to the engine and its components

- Do not let the indicator needle of the tachometer enter the red zone, which indicates the maximum engine speed.
- The engine may be overheating if the high engine coolant temperature warning light (Red) flashes or comes on. In this case, immediately stop the vehicle in a safe place, and check the engine after it has cooled completely. (→P. 569)

2-2. Instrument cluster Indicators and warning lights

The indicator and warning lights on the instrument cluster and center panel inform the driver of the status of the vehicle's various systems.

For the purpose of explanation, the following illustration displays all indicators and warning lights illuminated.

► Instrument cluster (left-hand drive vehicles)*

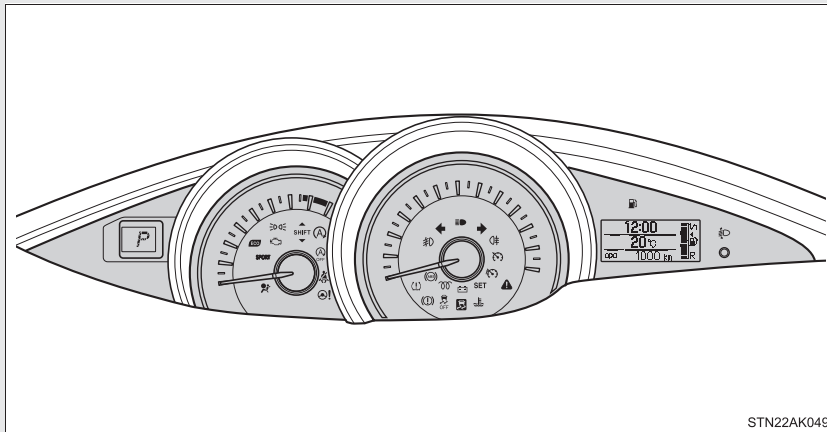

► Instrument cluster (right-hand drive vehicles)*

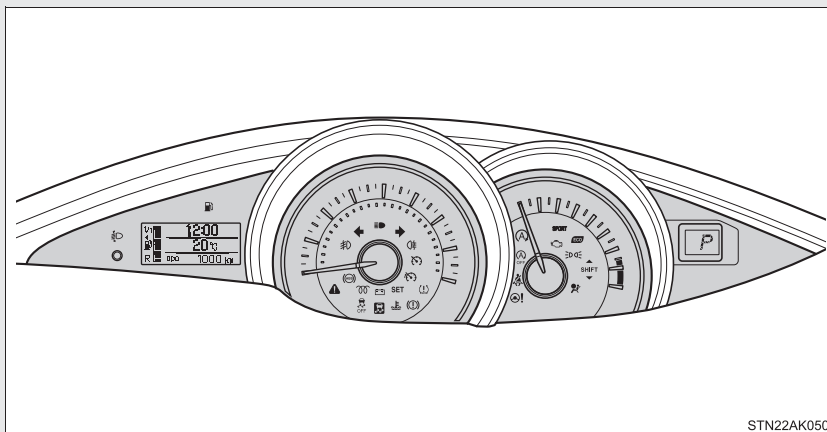

*: The units used on the speedometer, tachometer and some indicators may differ depending on the engine, transmission, etc.

2-2. Instrument cluster

► Center panel (vehicles with manual air conditioning system)

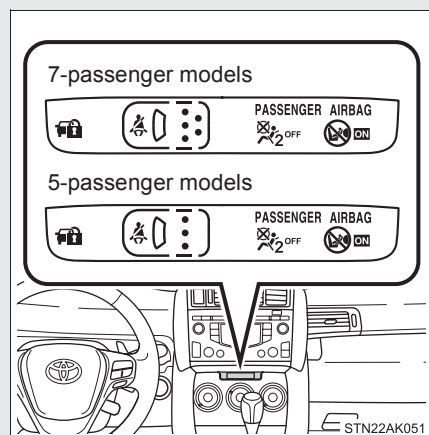



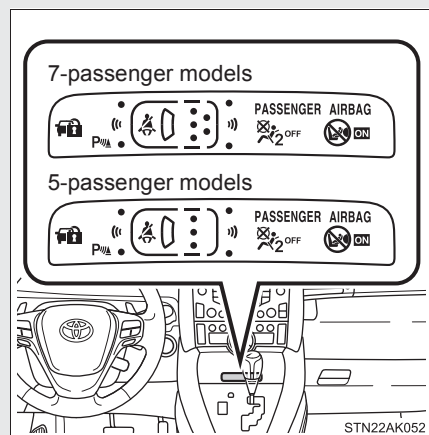















► Center panel (vehicles with automatic air conditioning system)



■ Indicators

The indicators inform the driver of the operating state of the vehicle's various systems.

	Turn signal indicator (→P. 218)		"SET" indicator (→P. 258)
		(if equipped)	
	Headlight high beam indicator (→P. 245)		Speed limiter indicator (→P. 262)
		(if equipped)	
	Tail light indicator (→P. 244)		Eco Driving Indicator Light (→P. 188, 242)
		*1, 3 (if equipped)	
	Front fog light indicator (→P. 251)		Stop & Start indicator (→P. 273)
		*1 (if equipped)	
	Rear fog light indicator (→P. 251)		Stop & Start cancel indicator (→P. 274)
		*1 (if equipped)	
	*1, 2 Slip indicator (→P. 281)		*4 Engine coolant temperature indicator
		(Blue)	
	*1 VSC off indicator (→P. 281)		*3 Shift position indicator (→P. 208)
	Engine preheating indicator (→P. 198, 202) (diesel engine)		*1, 5 Gear Shift Indicator (→P. 215)
	Cruise control indicator (→P. 258) (if equipped)		*3 "SPORT" indicator (→P. 209)

2-2. Instrument cluster



Security indicator
(→P. 124, 136)



(if equipped)

Toyota parking assist-sensor
indicator (→P. 265)



*1
“PASSENGER AIRBAG” indicator
(→P. 178)

*1: These lights turn on when the engine switch is turned to the “ON” position (vehicles without smart entry & start system) or the “ENGINE START STOP” switch is turned to IGNITION ON mode (vehicles with smart entry & start system) to indicate that a system check is being performed. They will turn off after the engine is started, or after a few seconds. There may be a malfunction in a system if a light does not come on, or if the lights do not turn off. Have the vehicle inspected by any authorized Toyota dealer or repairer, or another duly qualified and equipped professional for details.

*2: The light flashes to indicate that the system is operating.

*3: Vehicles with a Multidrive

*4: This indicator turns on in blue when the engine coolant temperature is low.

*5: Vehicles with a manual transmission

■ Warning lights

Warning lights inform the driver of malfunctions in any of the vehicle's systems. (→P. 500)

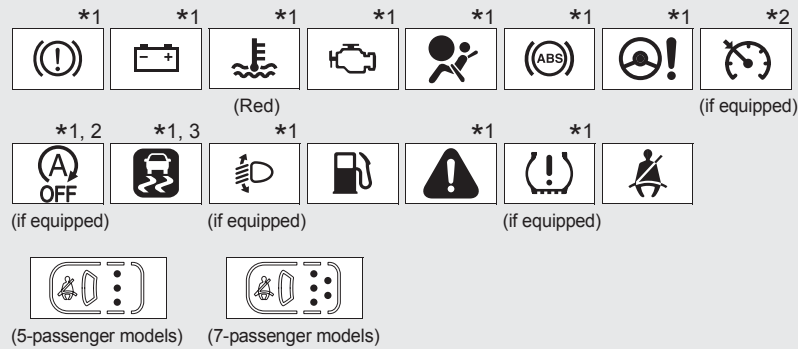

*1: These lights turn on when the engine switch is turned to the "ON" position (vehicles without smart entry & start system) or the "ENGINE START STOP" switch is turned to IGNITION ON mode (vehicles with smart entry & start system) to indicate that a system check is being performed. They will turn off after the engine is started, or after a few seconds. There may be a malfunction in a system if a light does not come on, or if the lights do not turn off. Have the vehicle inspected by any authorized Toyota dealer or repairer, or another duly qualified and equipped professional for details.

*2: The light flashes to indicate a malfunction.

*3: The light comes on to indicate a malfunction.

⚠ CAUTION

■ If a safety system warning light does not come on

Should a safety system light such as ABS and the SRS airbag warning light not come on when you start the engine, this could mean that these systems are not available to help protect you in an accident, which could result in death or serious injury. Have the vehicle inspected by any authorized Toyota dealer or repairer, or another duly qualified and equipped professional immediately if this occurs.

2-2. Instrument cluster

Multi-information display

The multi-information display presents the driver with a variety of driving-related data.

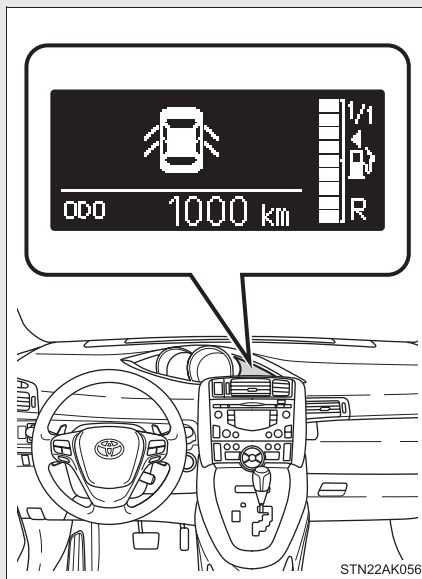

- Trip information (→P. 233)

Displays driving range, fuel consumption and other cruising-related information.

- Date (→P. 233)

Indicates the date and sets it.

- Outside temperature display (→P. 233)

Indicates the outside temperature.

- Warning messages (→P. 509)

Automatically displayed when a malfunction occurs in one of the vehicle's systems.

Switch the display

▶ Type A

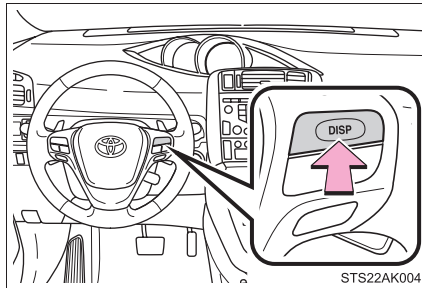

Display items can be switched by pressing the “DISP” switch.

▶ Type B

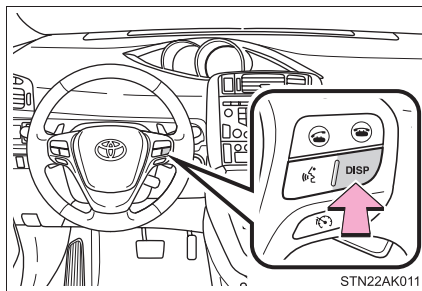

Display items can be switched by pressing the “DISP” switch.

2

When driving

Trip information

● Date and outside temperature display



Displays the date and outside temperature.

The temperature range that can be displayed is from -40°C (-40°F) to 50°C (122°F).

● Instantaneous fuel consumption

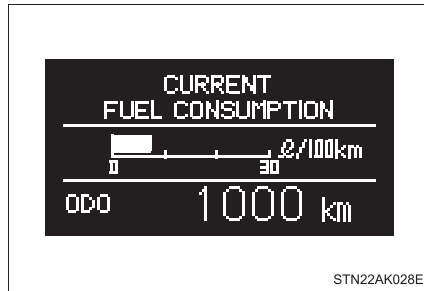

Displays the instantaneous fuel consumption.

● Average fuel consumption

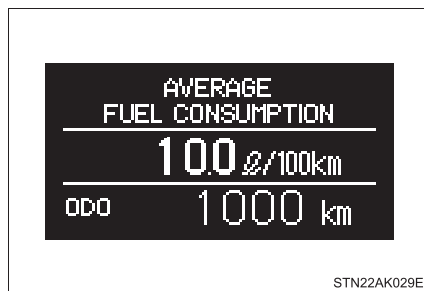

Displays the average fuel consumption since the function was last reset.

- The function can be reset by pressing the "DISP" switch for longer than 1 second when the average fuel consumption is displayed.
- Use the displayed average fuel consumption as a reference.

● Eco Driving Indicator Zone Display (if equipped)



Eco Driving Indicator indicates the range where acceleration is Eco-friendly, "Zone of Eco driving" and Eco driving ratio based on acceleration.

● Driving range

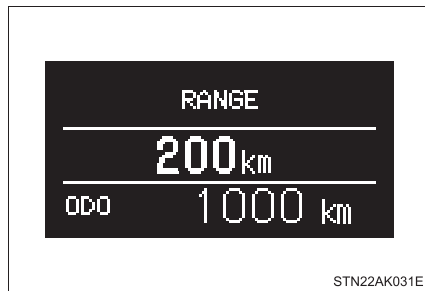

Displays the estimated maximum distance that can be driven with the quantity of fuel remaining.

- This distance is computed based on your average fuel consumption. As a result, the actual distance that can be driven may differ from that displayed.

- When only a small amount of fuel is added to the tank, the display may not be updated.

Vehicles without smart entry & start system:

When refueling, turn the engine switch to the “LOCK” position. If the vehicle is refueled without turning the engine switch to the “LOCK” position, the display may not be updated.

Vehicles with smart entry & start system:

When refueling, turn the “ENGINE START STOP” switch off. If the vehicle is refueled without turning the “ENGINE START STOP” switch off, the display may not be updated.

2

When driving

● Average vehicle speed

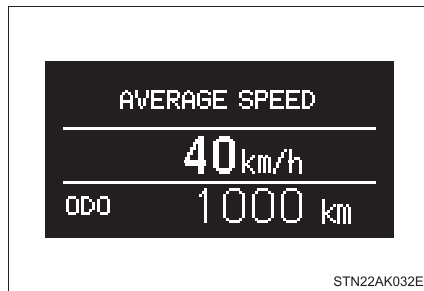

Displays the average vehicle speed since the engine was started or since the function was last reset.

The function can be reset by pressing the "DISP" switch for longer than 1 second when the average vehicle speed is displayed.

● Elapsed time

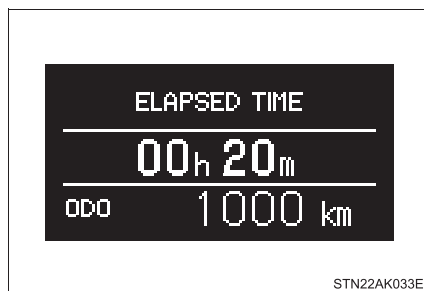

Displays the elapsed time since the engine was started or since the function was last reset.

The function can be reset by pressing the "DISP" switch for longer than 1 second when the elapsed time is displayed.

Set up display

■ **Before setting**

STEP 1 Display the settings screen on the multi-information display when the vehicle is stopped.



Press and hold the “DISP” switch to enter the adjustment mode.

STEP 3 Select the desired item on the menu screen.
Press and hold the “DISP” switch to enter the adjustment mode.

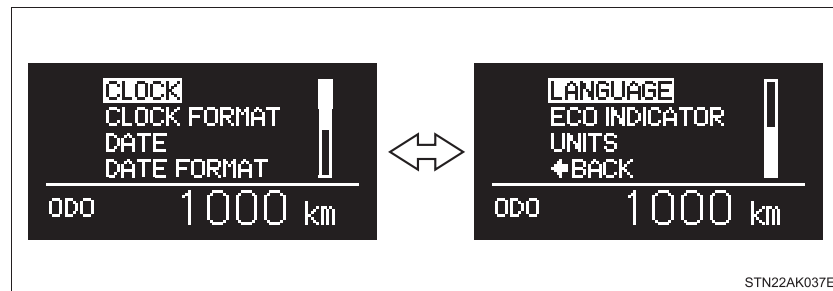

2

When driving

■ Setting the clock

STEP 1 Select "CLOCK" on the menu screen.



Press the "DISP" switch to adjust the hours.

After setting the hours, wait for 5 seconds until the bar disappears, and confirm that the hour has been input.

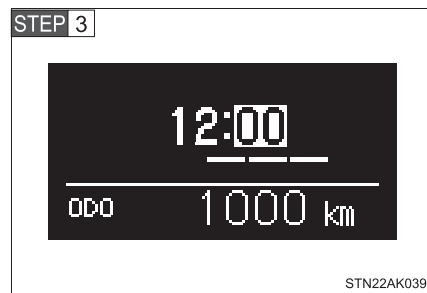

Press the "DISP" switch to adjust the minutes.

After setting the minutes, wait for 5 seconds until the bar disappears, and confirm that the minutes has been input.

■ Setting the clock format

STEP 1 Select "CLOCK FORMAT" on the menu screen.



Select the desired clock format.

Press and hold the "DISP" switch to input the choice.

■ Setting the date

STEP 1 Select "DATE" on the menu screen.



Press the "DISP" switch to adjust the year.

After setting the year, wait for 5 seconds until the bar disappears, and confirm that the year has been input.



Press the "DISP" switch to adjust the month.

After setting the month, wait for 5 seconds until the bar disappears, and confirm that the month has been input.



Press the "DISP" switch to adjust the day.

After setting the day, wait for 5 seconds until the bar disappears, and confirm that the day has been input.

2

When driving

■ Setting the date format

STEP 1 Select "DATE FORMAT" on the menu screen.



Select the desired date format.

Press and hold the "DISP" switch to input the choice.

■ Selecting the language

STEP 1 Select "LANGUAGE" on the menu screen.

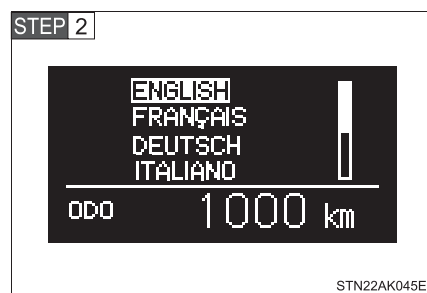

Select the desired language.

Press and hold the "DISP" switch to input the choice.

■ Setting Eco Driving Indicator Light

STEP 1 Select "ECO INDICATOR" on the menu screen.



Select "OFF" from the displayed items.

Then keep the switch pressed for a while.

Eco Driving Indicator Light is deactivated.

(To activate Eco Driving Indicator Light, select "ON".)

■ **Selecting the units**

STEP 1 Select "UNITS" on the menu screen.

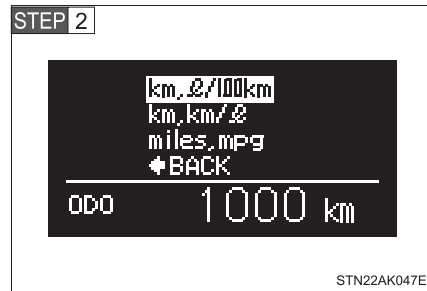

Select the desired unit.

Press and hold the "DISP" switch to input the choice.

■ **Returning the previous screen**

Select "←BACK" on the screen.

Press and hold the "DISP" switch to input the choice.

2

When driving

■ Eco Driving Indicator Zone Display (if equipped)

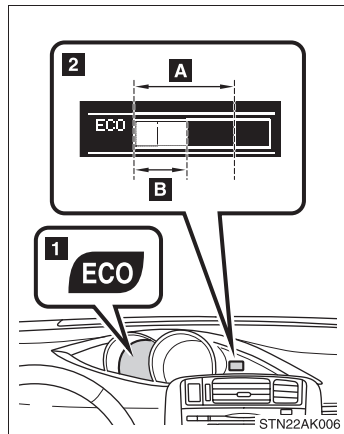

Eco Driving Indicator indicates the range where acceleration is Eco-friendly, “Zone of Eco driving” and Eco driving ratio based on acceleration.

- 1 Eco Driving Indicator Light
- 2 Eco Driving Indicator Zone Display
 - A Zone of Eco driving
 - B Eco driving ratio based on acceleration

When the acceleration exceeds the Zone of Eco driving, the system recognizes that the vehicle is not being driven in Eco-friendly manner. Eco Driving Indicator Light turns off and the right side of Eco Driving Indicator Zone Display blinks.

Also, the system will not be operated if the following conditions are met while driving:

- The shift position is anything other than “D”
- The driving mode is set to “SPORT” mode
- The paddle shift switch is operated while the shift lever is in “D”
- The vehicle speed is approximately 130 km/h (80 mph) or higher

■ Outside temperature display

- In the following situations, the correct outside temperature may not be displayed, or the display may take longer than normal to change.
 - When stopped, or driving at low speeds (less than 20 km/h [12 mph])
 - When the outside temperature has changed suddenly (at the entrance/exit of a garage, tunnel, etc.)
- When “--” is displayed, the system may be malfunctioning.
Take your vehicle to any authorized Toyota dealer or repairer, or another duly qualified and equipped professional.

■ **Liquid crystal display**

Small spots or light spots may appear on the display. This phenomenon is characteristic of liquid crystal displays, and there is no problem to continue using the display.

 **NOTICE**

■ **The multi-information display at low temperatures**

Allow the interior of the vehicle to warm up before using the liquid crystal information display. At extremely low temperatures, the information display monitor may respond slowly, and display changes may be delayed.

2

When driving

2-3. Operating the lights and wipers

Headlight switch

The headlights can be operated manually or automatically.

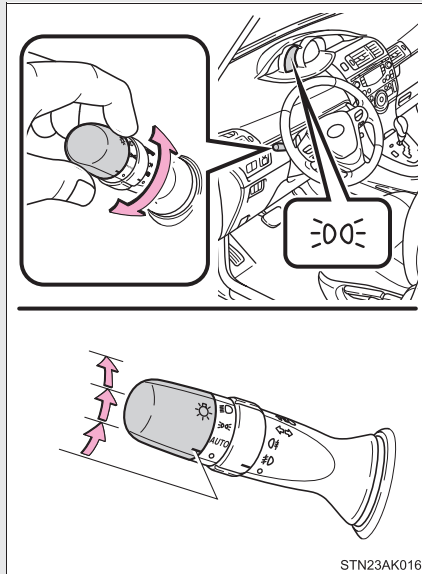

The front position, tail, license plate and instrument panel lights turn on.



The headlights and all lights listed above turn on.

AUTO

(if equipped)

Vehicles without smart entry & start system: The headlights, front position lights and so on turn on and off automatically (when the engine switch is in the "ON" position.)

Vehicles with smart entry & start system: The headlights, front position lights and so on turn on and off automatically (when the "ENGINE START STOP" switch is in IGNITION ON mode.)

Turning on the high beam headlights

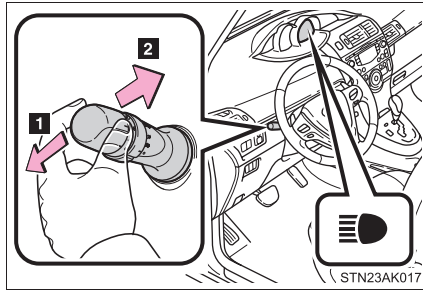

1 With the headlights on, push the lever forward to turn on the high beams.

Pull the lever back to the center position to turn the high beams off.

2 Pull the lever toward you to turn on the high beams.

Release the lever to turn them off. You can flash the high beams with the headlights on or off.

2

When driving

Manual headlight leveling dial (vehicles with halogen headlights)

The level of the headlights can be adjusted according to the number of passengers and the loading condition of the vehicle.

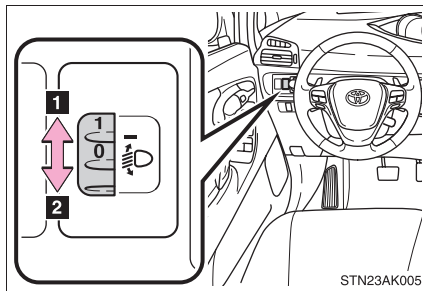

1 Raises the level of the headlights

2 Lowers the level of the headlights

■ **Guide to dial settings**

▶ **Vehicle category M1***

Loading condition	Control switch position	
	5 SEATER	7 SEATER
Driver only	0	0
Driver + one passenger in the front seat	0	0
Driver + one passenger in the front seat. And all passengers in the rear seats farthest to the rear.	1	1
All passengers	1	2
All passengers + full luggage loading to the luggage room.	3	3
Driver + full luggage loading to the luggage room	4	4

▶ **Vehicle category N1***

Loading condition	Control switch position
Driver only	0
Driver + full luggage loading to the luggage room	3

*: To distinguish the vehicle category, ask any authorized Toyota dealer or repairer, or another duly qualified and equipped professional.

Daytime running light system (if equipped)

To make your vehicle more visible to other drivers, the daytime running lights turn on automatically whenever the engine is started. (However, the daytime running light system will be canceled when the headlight switch is operated manually or the automatic headlight system turns on the tail lights.) Daytime running lights are not designed for use at night.

■ **Deactivating/reactivating the daytime running light system**

Follow the procedure below.

STEP 1 Vehicles without smart entry & start system: Turn the engine switch to the “ON” position. Turn off the headlights, tail lights and automatic headlights system, and set the parking brake. Vehicles with smart entry & start system: Turn the “ENGINE START STOP” switch to IGNITION ON mode. Turn off the headlights, tail lights and automatic headlights system, and set the parking brake.

STEP 2 Start the engine.

You must perform step 3 within 5 seconds of starting the engine.

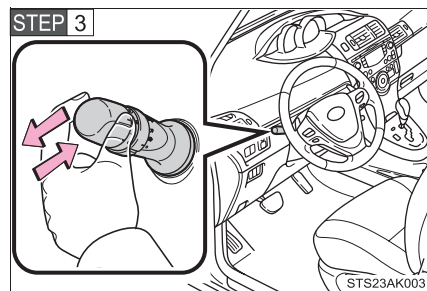

Push the headlight switch forward and pull it back to the center position. (Repeat this operation 3 times or more.)

A buzzer will sound to indicate that the daytime running light system has been deactivated/reactivated.

2

When driving

2-3. Operating the lights and wipers

If any of the following occurs during the deactivation/reactivation operation, the deactivation/reactivation operation will be canceled:

- The engine is turned off.
- The parking brake is released.
- The vehicle is moving.
- The headlights are turned on.
- The tail lights are turned on.
- The automatic headlight system is turned on.

■ Headlight control sensor (if equipped)

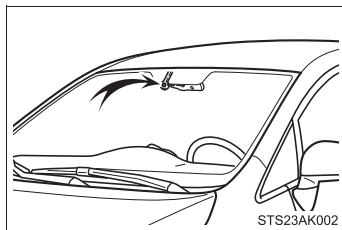





The sensor may not function properly if anything that blocks the sensor is affixed to the windshield.

Doing so interferes with the sensor detecting the level of ambient light and may cause the automatic headlight system to malfunction.



■ Automatic light off system



▶ Vehicles without smart entry & start system

- When the light switch is in the **AUTO** position, the headlight and all the lights turn off automatically if the engine switch is turned to the “ACC” or “LOCK” position.
- When the light switch is in the  or  position, the headlights and front fog lights turn off automatically if the engine switch is turned to the “ACC” or “LOCK” position.

To turn the lights on again, turn the engine switch to the “ON” position, or turn the light switch off once and then back to the  or  position.

▶ Vehicles with smart entry & start system

- When the light switch is in the **AUTO** position, the headlight and all the lights turn off automatically if the “ENGINE START STOP” switch is turned to ACCESSORY mode or turned off.
- When the light switch is in the  or  position, the headlights and front fog lights turn off automatically if the “ENGINE START STOP” switch is turned to ACCESSORY mode or turned off.

To turn the lights on again, turn to IGNITION ON mode, or turn the light switch off once and then back to the  or  position.

■ Light reminder buzzer

▶ Vehicles without smart entry & start system

A buzzer sounds when the engine switch is turned to the “LOCK” or “ACC” position and the driver’s door is opened while the lights are turned on.

▶ Vehicles with smart entry & start system

A buzzer sounds when the “ENGINE START STOP” switch is turned off or to the ACCESSORY mode and the driver’s door is opened while the lights are turned on.

■ Automatic headlight leveling system (vehicles with discharge headlights)

The level of the headlights is automatically adjusted according to the number of passengers and the loading condition of the vehicle to ensure that the headlights do not interfere with other road users.

2-3. Operating the lights and wipers

■ Turning on the low beam headlights when the vehicle is parked in dark areas

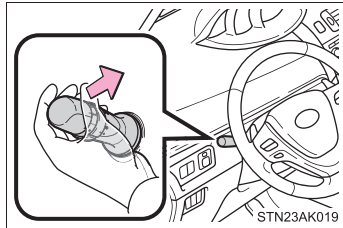

Turn off the engine with the light switch in **auto** or **off**, and pull the light switch toward you and release it. The low beam headlights will turn on for about 30 seconds to light up the area around the vehicle.

The lights are turned off in the following situations.

- Vehicles without smart entry & start system:
The engine switch is turned to the “ON” position.
- Vehicles with smart entry & start system:
The “ENGINE START STOP” switch is turned to IGNITION ON mode.
- The light switch is turned on.
- The light switch is pulled toward you and then released.

■ Customization that can be configured at any authorized Toyota dealer or repairer, or another duly qualified and equipped professional

Settings of the light sensor sensitivity can be changed.
(Customizable features →P. 602)

NOTICE

■ To prevent battery discharge

Do not leave the lights on longer than necessary when the engine is not running.

2-3. Operating the lights and wipers

Fog light switch

The fog lights secure excellent visibility in difficult driving conditions, such as in rain and fog.

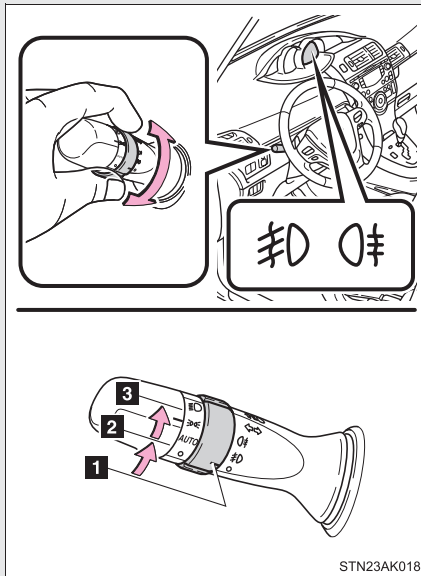

- 1 ○ Turns the front and rear fog light off
- 2 ⊘ Turns the front fog lights on
- 3 ⊘ Turns both front and rear fog lights on

Releasing the switch ring returns it to ⊘.

Operating the switch ring again turns only the rear fog light off.

2

When driving

■ Fog lights can be used when

Front fog lights: The headlights or front position lights are turned on.





Rear fog light: The front fog lights are turned on.

2-3. Operating the lights and wipers Windshield wipers and washer

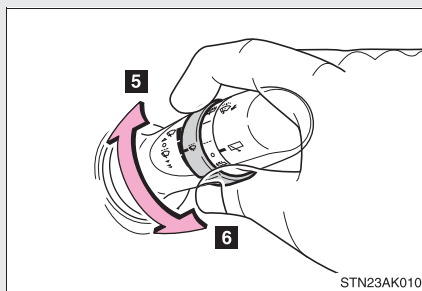
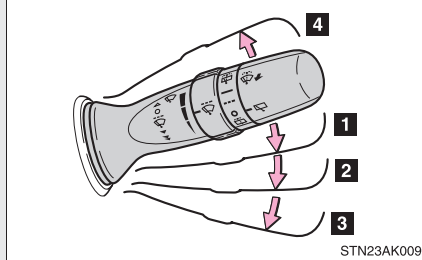
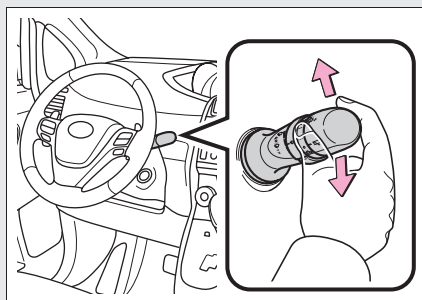
■ Intermittent windshield wipers with interval adjuster (if equipped)

Wiper intervals can be adjusted for intermittent operation (when  is selected).



- 1  Intermittent windshield wiper operation
- 2  Low speed windshield wiper operation
- 3  High speed windshield wiper operation
- 4  Temporary operation
- 5 Increases the intermittent windshield wiper frequency
- 6 Decreases the intermittent windshield wiper frequency

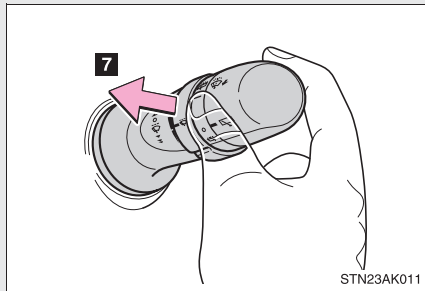

7 Wash/wipe operation

Wipers operate automatically.

Vehicles with headlight cleaners: →P. 255

■ Rain-sensing windshield wipers (if equipped)

With **AUTO** selected, the wipers will operate automatically when the sensor detects falling rain. The system automatically adjusts wiper timing in accordance with rain volume.

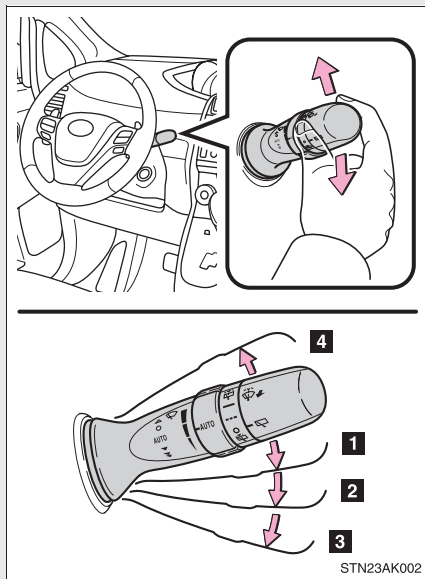

1 **AUTO** Rain-sensing windshield wiper operation

2 **▼** Low speed windshield wiper operation

3 **▼▼** High speed windshield wiper operation

4 **▲** Temporary operation

2-3. Operating the lights and wipers

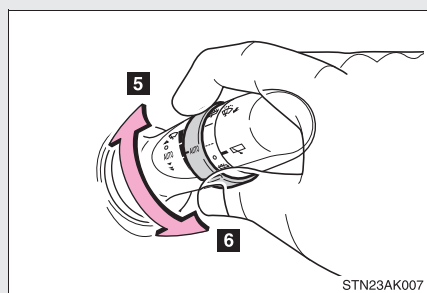

5 Sensor sensitivity (high)

6 Sensor sensitivity (low)

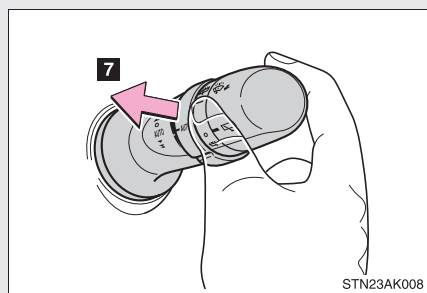

7 Wash/wipe operation

Wipers operate automatically.

Vehicles with headlight cleaners: →P. 255

■ The windshield wipers and washer can be operated when

- ▶ Vehicles without smart entry & start system

The engine switch is in the "ON" position.

- ▶ Vehicles with smart entry & start system

The "ENGINE START STOP" switch is in IGNITION ON mode.

■ The headlight cleaners operation (if equipped)

▶ Vehicles without smart entry & start system

When the windshield washer is operated with the engine switch in the "ON" position and the headlights turned on, the headlight cleaners will operate once. (Afterwards, the headlight cleaners operate automatically once for every 5 times the windshield washer is operated.)

To operate the headlight cleaners again, pull back the washer lever 5 times.

(If the headlights are turned off and then on again, and then the windshield washer is operated, the headlight cleaners will operate once.)

▶ Vehicles with smart entry & start system

When the windshield washer is operated with the "ENGINE START STOP" switch in IGNITION ON mode and the headlights turned on, the headlight cleaners will operate once. (Afterwards, the headlight cleaners operate automatically once for every 5 times the windshield washer is operated.)

To operate the headlight cleaners again, pull back the washer lever 5 times.

(If the headlights are turned off and then on again, and then the windshield washer is operated, the headlight cleaners will operate once.)

■ Rain drop sensor (vehicles with rain-sensing windshield wipers)

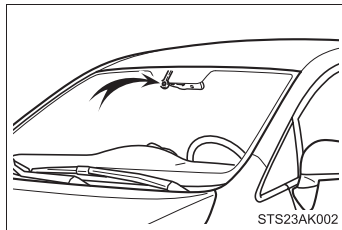

- The raindrop sensor judges the amount of raindrops.

● Vehicles without smart entry & start system:

If the wiper switch is turned to the AUTO position while the engine switch is in the "ON" position, the wiper will operate once to show that AUTO mode is activated.

If the wiper sensitivity is adjusted to higher, the wiper may operate once to indicate the change of sensitivity.

2-3. Operating the lights and wipers

- Vehicles with smart entry & start system:

If the wiper switch is turned to the **AUTO** position while the “ENGINE START STOP” switch is in **IGNITION ON** mode, the wiper will operate once to show that **AUTO** mode is activated.

If the wiper sensitivity is adjusted to higher, the wiper may operate once to indicate the change of sensitivity.

- If the temperature of the raindrop sensor is 85°C (185°F) or higher, or -40°C (-40°F) or lower, automatic operation may not occur. In this case, operate the wipers in any mode other than **AUTO**.

- **If no windshield washer fluid sprays**

Check that the washer nozzles are not blocked and if there is washer fluid in the windshield washer fluid reservoir.

CAUTION

- **Caution regarding the use of windshield wipers in AUTO mode**

The windshield wipers may operate unexpectedly if the sensor is touched or the windshield is subject to vibration in **AUTO** mode. Take care that your fingers or anything else do not become caught in the windshield wipers.

- **Caution regarding the use of washer fluid**

When it is cold, do not use the washer fluid until the windshield becomes warm. The fluid may freeze on the windshield and cause low visibility. This may lead to an accident, resulting in death or serious injury.

NOTICE

- **When the windshield is dry**

Do not use the wipers, as they may damage the windshield.

- **When the washer fluid tank is empty**

Do not use the washer when the washer fluid tank is empty. This may cause the washer fluid pump to overheat.



- **When there is no windshield washer fluid spray from the nozzle**

Damage to the washer fluid pump may be caused if the lever is pulled toward you and held continually.

2-3. Operating the lights and wipers

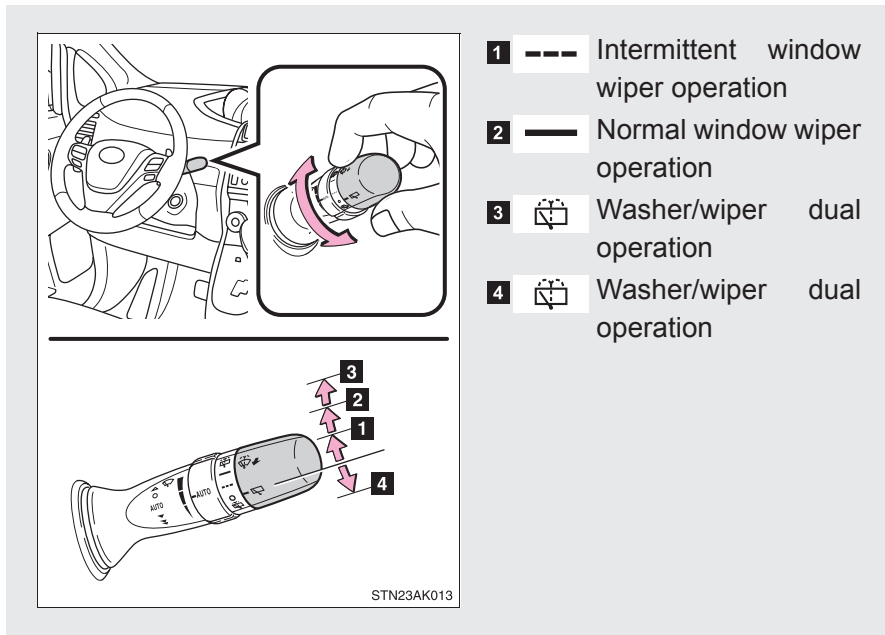
Rear window wiper and washer



- 1 - - - Intermittent window wiper operation
- 2 — Normal window wiper operation
- 3  Washer/wiper dual operation
- 4  Washer/wiper dual operation

2

When driving

■ The rear window wiper and washer can be operated when

- ▶ Vehicles without smart entry & start system
 - The engine switch is in the "ON" position.
- ▶ Vehicles with smart entry & start system
 - The "ENGINE START STOP" switch is in IGNITION ON mode.

NOTICE

■ When the rear window is dry

Do not use the wipers, as they may damage the rear window.

■ When the washer fluid tank is empty

Do not use the washer when the washer fluid tank is empty. This may cause the washer fluid pump to overheat.

2-4. Using other driving systems

Cruise control*

Use the cruise control to maintain a set speed without depressing the accelerator pedal.

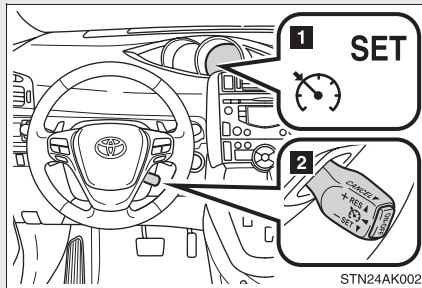

- 1 Indicators
- 2 Cruise control switch

■ Setting the vehicle speed

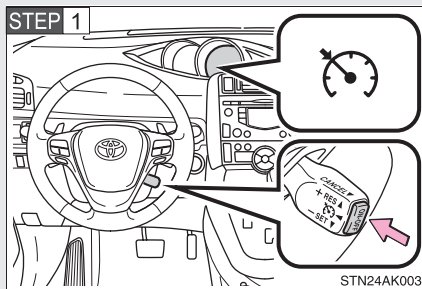

Press the “ON-OFF” button to activate the cruise control.

Cruise control indicator will come on.

Press the button again to deactivate the cruise control.

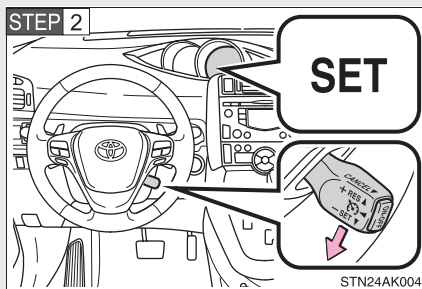

Accelerate or decelerate the vehicle to the desired speed, and push the lever down to set the speed.

“SET” indicator will come on.

The vehicle speed at the moment the lever is released becomes the set speed.

*: If equipped

■ **Adjusting the set speed**

To change the set speed, operate the lever until the desired set speed is obtained.

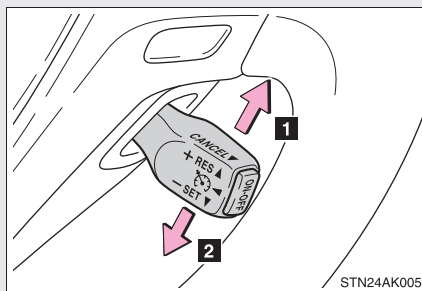

1 Increase the speed

2 Decrease the speed

Fine adjustment: Momentarily move the lever in the desired direction.

Large adjustment: Hold the lever in the desired direction.

The set speed will be increased or decreased as follows:

Fine adjustment: By approximately 1.6 km/h (1 mph) each time the lever is operated.

Large adjustment: The set speed can be increased or decreased continually until the lever is released.

■ **Canceling and resuming the constant speed control**

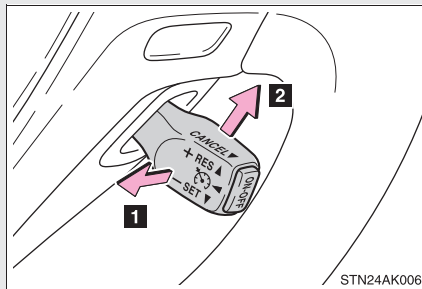

1 Pulling the lever toward you cancels the constant speed control.

The speed setting is also canceled when the brakes are applied or the clutch pedal (manual transmission only) is depressed.

2 Pushing the lever up resumes the constant speed control.

Resuming is available when the vehicle speed is more than approximately 40 km/h (25 mph).

■ **Cruise control can be set when**

- On vehicles with a Multidrive, the shift lever is in the “D” or range 4 or higher of “M” has been selected.
- On vehicles with a Multidrive, range 4 or higher has been selected by using the paddle shift.
- Vehicle speed is above approximately 40 km/h (25 mph).

■ **Accelerating after setting the vehicle speed**

- The vehicle can be accelerated normally. After acceleration, the set speed resumes.
- Even without canceling the cruise control, the set speed can be increased by first accelerating the vehicle to the desired speed and then pushing the lever down to set the new speed.

■ **Automatic cruise control cancellation**

Cruise control will stop maintaining the vehicle speed in any of the following situations.

- Actual vehicle speed falls more than approximately 16 km/h (10 mph) below the preset vehicle speed.
At this time, the memorized set speed is not retained.
- Actual vehicle speed is below approximately 40 km/h (25 mph).
- VSC+ is activated.
- Speed limiter is activated (if equipped).

■ **If the cruise control indicator light flashes**

Press the “ON-OFF” button once to deactivate the system, and then press the button again to reactivate the system.

If the cruise control speed cannot be set or if the cruise control cancels immediately after being activated, there may be a malfunction in the cruise control system. Have the vehicle inspected by any authorized Toyota dealer or repairer, or another duly qualified and equipped professional.

 CAUTION

■ **To avoid operating the cruise control by mistake**

Switch the cruise control off using the “ON-OFF” button when not in use.

■ **Situations unsuitable for cruise control**

Do not use cruise control in any of the following situations. Doing so may result in loss of control and could cause an accident resulting in death or serious injury.

- In heavy traffic
- On roads with sharp bends
- On winding roads
- On slippery roads, such as those covered with rain, ice or snow
- On steep hills
Vehicle speed may exceed the set speed when driving down a steep hill.
- When your vehicle is towing a trailer

2-4. Using other driving systems

Speed limiter*

A desired maximum speed can be set using the cruise control switch.

The speed limiter prevents vehicle speed from exceeding the set speed.

■ Setting the vehicle speed

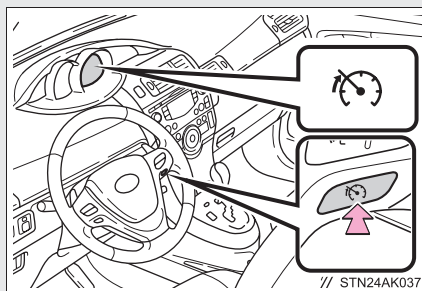

Press the switch to activate the speed limiter.

Press the switch once more to deactivate the speed limiter.

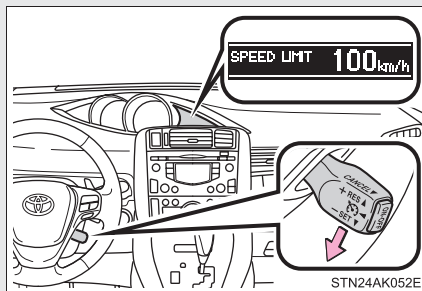

Accelerate or decelerate to the desired speed and push the lever down to set the desired maximum speed.

*: If equipped

■ **Adjusting the speed setting**

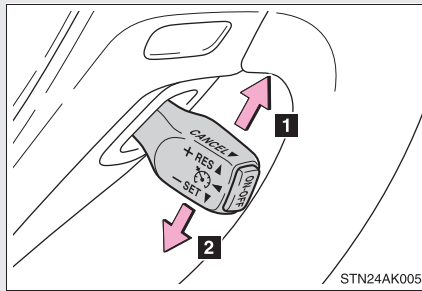

- 1 Increase speed
- 2 Decrease speed

Hold the lever until the desired speed setting is obtained.

Fine adjustment of the set speed can be made by lightly pushing the lever up or down and releasing it.

■ **Canceling and resuming the speed limiter**

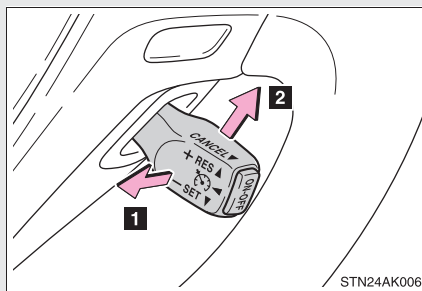

- 1 Cancel

Pull the lever towards you to cancel the speed limiter.

- 2 Resume

To resume use of the speed limiter, push the lever up.

2

When driving

■ **Speed limiter can be set when**

The vehicle speed is more than approximately 30 km/h (18 mph).

2-4. Using other driving systems

■ Exceeding the set speed

In the following situations, when the vehicle speed exceeds the set speed, the multi-information display will be highlighted:

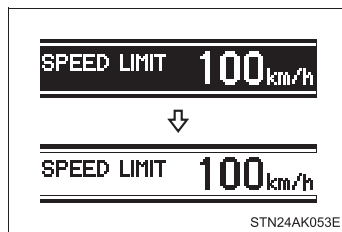

- When fully depressing the accelerator pedal
- When driving down a hill (a buzzer also sounds)

■ Automatic speed limiter cancellation

The set speed is automatically canceled when the cruise control is activated.

⚠ CAUTION

■ To avoid operating the speed limiter by mistake

Keep the speed limiter switch off when not in use.

■ Situations unsuitable for speed limiter

Do not use the speed limiter in either of the following situations. Doing so may result in control of the vehicle being lost and could cause a serious or fatal accident.

- On slippery roads, such as those covered with rain, ice or snow
- On steep hills
- When towing a trailer

2-4. Using other driving systems

Toyota parking assist-sensor*

The distance from your vehicle to nearby obstacles when parallel parking or maneuvering into a garage is measured by the sensors and communicated via an indicator and a buzzer. Always check the surrounding area when using this system.

■ Types of sensors

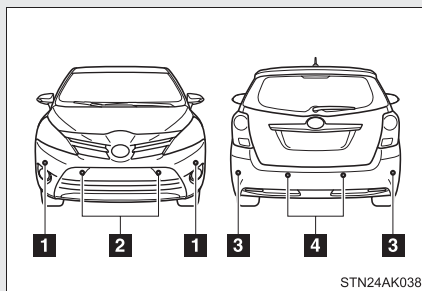

- 1 Front corner sensors
- 2 Front center sensors
- 3 Rear corner sensors
- 4 Rear center sensors

■ Toyota parking assist-sensor switch

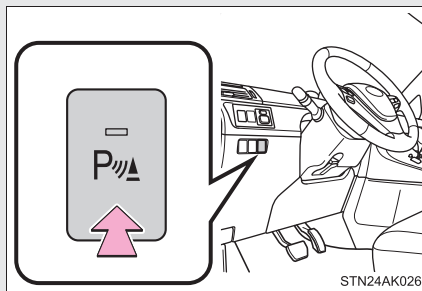

Turns the Toyota parking assist-sensor on/off

When on, the indicator light comes on to inform the driver that the system is operational.

*: If equipped

Display

When the sensors detect an obstacle, the Toyota parking assist-sensor indicator is illuminated by an LED depending on position and distance to the obstacle.

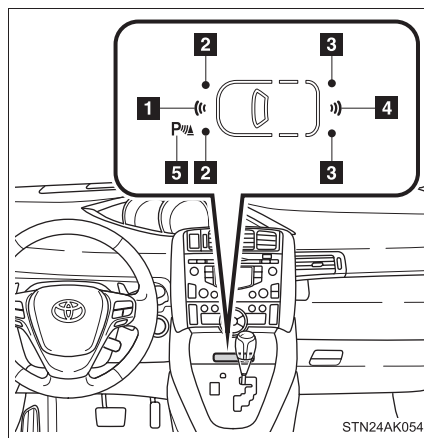

- 1 Front center sensor operation
- 2 Front corner sensor operation
- 3 Rear corner sensor operation
- 4 Rear center sensor operation
- 5 The light comes on to indicate that the system is operating

The distance display and buzzer

When a sensor detects an obstacle, the direction of and the approximate distance to the obstacle are displayed and the buzzer sounds.

■ Sensor operation and distance to an obstacle

The system operates when the vehicle approaches an obstacle, as shown by the following table.

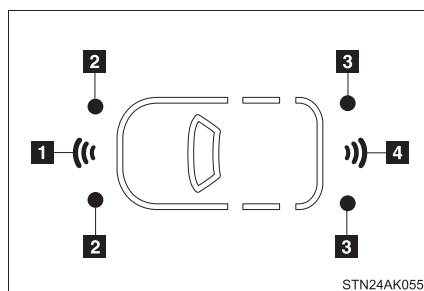

1 Front center sensor

Distance to an obstacle cm (ft.)	Indicator and buzzer
Approximately 100 - 50 (3.2 - 1.6)	Intermittent
Approximately 50 - 37.5 (1.6 - 1.2)	Fast intermittent
Approximately 37.5 - 30 (1.2 - 1.0)	Very fast intermittent
Approximately 30 or less (1.0 or less)	Continuous

2 Front corner sensor

Distance to an obstacle cm (ft.)	Indicator and buzzer
Approximately 60 - 45 (2.0 - 1.5)	Intermittent
Approximately 45 - 30 (1.5 - 1.0)	Fast intermittent
Approximately 30 or less (1.0 or less)	Continuous

3 Rear corner sensor

Distance to an obstacle cm (ft.)	Indicator and buzzer
Approximately 60 - 45 (2.0 - 1.5)	Intermittent
Approximately 45 - 30 (1.5 - 1.0)	Fast intermittent
Approximately 30 or less (1.0 or less)	Continuous

4 Rear center sensor

Distance to an obstacle cm (ft.)	Indicator and buzzer
Approximately 150 - 60 (4.9 - 2.0)	Intermittent
Approximately 60 - 45 (2.0 - 1.5)	Fast intermittent
Approximately 45 - 35 (1.5 - 1.1)	Very fast intermittent
Approximately 35 or less (1.1 or less)	Continuous

■ Buzzer operation and distance to an obstacle

A buzzer sounds when the corner sensors and center sensors are operating.

- The buzzer beeps faster as the vehicle approaches an obstacle. When the vehicle comes within the following distance of the obstacle, the buzzer sounds continuously.
 - Front corner sensors: Approximately 30 cm (1.0 ft.)
 - Front center sensors: Approximately 30 cm (1.0 ft.)
 - Rear corner sensors: Approximately 30 cm (1.0 ft.)
 - Rear center sensors: Approximately 35 cm (1.1 ft.)
- When obstacles are simultaneously detected in front and to the rear:
 - The buzzer sounds in response to the nearest obstacle.
 - When an obstacle either in front or to the rear is extremely close, the buzzer will alternate between sounding continuously and sounding intermittently.
 - When obstacles both in front and to the rear are extremely close, the buzzer will alternate between sounding continuously and sounding intermittently, with a shorter interval.

■ Sensors that operate

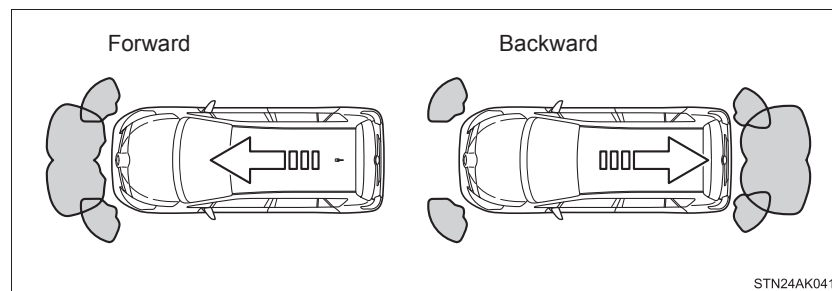

Detection range of the sensors

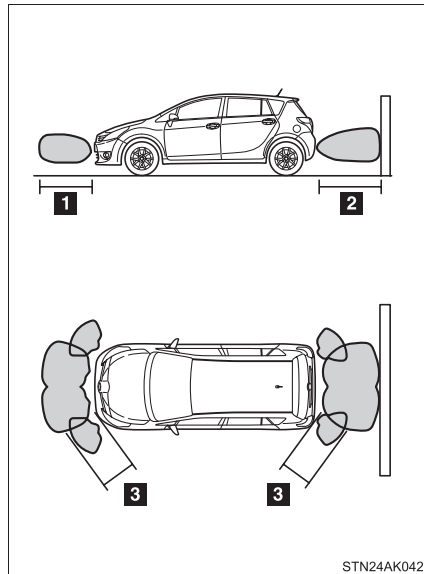

- 1 Approximately 100 cm (3.2 ft.)
- 2 Approximately 150 cm (4.9 ft.)
- 3 Approximately 60 cm (2.0 ft.)

The diagram shows the detection range of the sensors. Note that the sensors cannot detect obstacles that are extremely close to the vehicle.

The range of the sensors may change depending on the shape of the object etc.

2

When driving

■ The Toyota parking assist-sensor can be operated when

The Toyota parking assist-sensor switch is on.

Vehicles without smart entry & start system:

The engine switch is in "ON" position.

Vehicles with smart entry & start system:

The "ENGINE START STOP" switch is in IGNITION ON mode.

● Front center sensors:

- The shift lever is in a position other than "P" (Multidrive) or "R".
- The vehicle speed is less than about 10 km/h (6 mph).

● Front corner sensors:

- The shift lever is in a position other than "P" (Multidrive).
- The vehicle speed is less than about 10 km/h (6 mph).

● Rear corner and rear center sensors:

- The shift lever is in "R".

■ **Sensor detection information**

● Certain vehicle conditions and the surrounding environment may affect the ability of a sensor to correctly detect an obstacle. Particular instances where this may occur are listed below.

- There is dirt, snow or ice on a sensor.
- A sensor is frozen.
- A sensor is covered in any way.
- The vehicle is leaning considerably to one side.
- On an extremely bumpy road, on an incline, on gravel, or on grass.
- The vicinity of the vehicle is noisy due to vehicle horns, motorcycle engines, air brakes of large vehicles, or other loud noises producing ultrasonic waves.
- There is another vehicle equipped with parking assist sensors in the vicinity.
- A sensor is coated with a sheet of spray or heavy rain.
- The vehicle is equipped with a fender pole or radio antenna.
- Towing eyelet is installed.
- A bumper or sensor receives a strong impact.
- The vehicle is approaching a tall or right-angled curb.
- In harsh sunlight or intense cold weather.
- A non-genuine Toyota suspension (lowered suspension etc.) is installed.

In addition to the examples above, there are instances in which, because of their shape, signs and other objects may be judged by a sensor to be closer than they are.

● The shape of the obstacle may prevent a sensor from detecting it. Pay particular attention to the following obstacles:

- Wires, fences, ropes, etc.
- Cotton, snow and other materials that absorb sound waves
- Sharply-angles objects
- Low obstacles
- Tall obstacles with upper sections projecting outwards in the direction of your vehicle

■ When the sensor acts abnormal or malfunctions

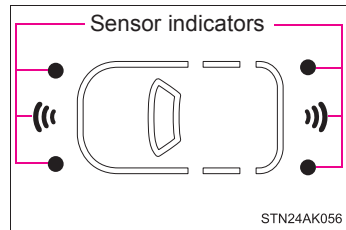

- When any of the sensors become dirty or frozen, the abnormal sensor indicator comes on and the buzzer sounds for 8 seconds. After sounding, all of the sensor indicators will come on.

Clean the sensors with soft cloth.

- When any of the sensors malfunction, the malfunctioning sensor indicator flashes and the buzzer will sound for 8 seconds. After sounding, all of the sensor indicators will flash.

Have the vehicle inspected by any authorized Toyota dealer or repairer, or another duly qualified and equipped professional.

■ Customization that can be configured at any authorized Toyota dealer or repairer, or another duly qualified and equipped professional

Setting of buzzer volume can be changed.
(Customizable features→P. 602)

⚠ CAUTION

■ Caution when using the Toyota parking assist-sensor

Observe the following precautions.

Failing to do so may result in the vehicle being unable to be driven safely and possibly cause an accident.

- Do not use the sensor at speeds in excess of 10 km/h (6 mph).
- Do not attach any accessories within the sensor range.

2-4. Using other driving systems

NOTICE

■ **Notes when washing the vehicle**

Do not apply intensive bursts of water or steam to the sensor area.
Doing so may result in the sensor malfunctioning.

2-4. Using other driving systems

Stop & Start system*

The Stop & Start system stops and restarts the engine according to the clutch pedal operation for stopping and starting the vehicle.

■ Stopping the engine

STEP 1 With the clutch pedal fully depressed, stop the vehicle. Then shift the shift lever to “N”.

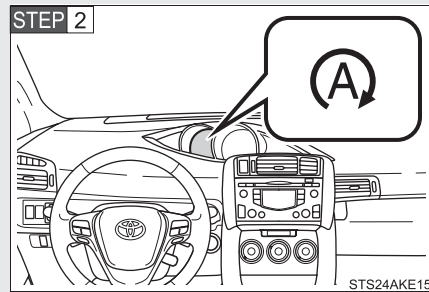

Release the clutch pedal.

The engine will stop and Stop & Start indicator will come on.

■ Restarting the engine

Check that the shift lever is in “N” and depress the clutch pedal.

The engine will restart. The Stop & Start indicator will go off.
(In this situation, releasing the clutch pedal will not stop the engine again.)

2

When driving

*: If equipped

Disabling the Stop & Start system

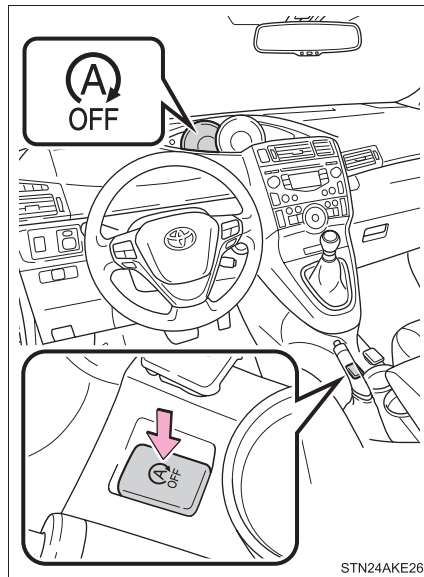

Press the Stop & Start cancel switch to disable the Stop & Start system.

The Stop & Start cancel indicator will come on.

The engine will not stop at each stop when the clutch pedal is depressed to stop the engine. (→P. 273)

Pressing the switch again to re-enable the Stop & Start system.

■ If the Stop & Start cancel switch is pressed while the vehicle is stopped

- When the engine is stopped by the Stop & Start system, pressing the Stop & Start cancel switch will restart the engine. From the next time the vehicle is stopped (after Stop & Start system has been turned off), the engine will not be stopped.
- With the Stop & Start system disabled, pressing the Stop & Start cancel switch will re-enable the system, not stop the engine. From the next time the vehicle is stopped (after Stop & Start system has been turned on), the engine will be stopped.

■ Operating conditions

- The Stop & Start system is operational when all of the following conditions are met:
 - The engine is adequately warmed up.
 - The battery is sufficiently charged.
 - The driver's door is closed.
 - The driver's seat belt is fastened.
 - The hood is closed.
 - The clutch pedal is not being depressed.
 - The shift lever is in "N".
 - The steering wheel is not in use.

- In the following circumstances the engine may not be stopped by the Stop & Start system. This is not a malfunction of the Stop & Start system.
 - Engine coolant temperature is too low or too high.
 - The outside temperature is too low.
 - Vehicles with an automatic air conditioning system: The air conditioning system is being used when the vehicle interior temperature is extremely high such as after the vehicle was parked under the hot sun.
 - Vehicles with an automatic air conditioning system: The windshield defogger is being used.
 - Vehicles with a power heater: The power heater is being used.
 - The battery is not sufficiently charged, or is undergoing a periodic recharge.
 - Due to traffic or other circumstances the vehicle is stopped repeatedly, resulting in the amount of time the engine is stopped by the Stop & Start system to become excessively high.
 - The brake booster vacuum is low.
 - A large amount of electricity is being used.
 - At high altitude.

When the above conditions improve, the Stop & Start system will stop and restart the engine from the next time the vehicle is stopped.

- In the following situations, it may take longer than normal for the Stop & Start system to activate.
 - The battery is discharged.
 - After the battery terminals have been disconnected and reconnected after a battery replacement, etc.
 - The engine coolant temperature is low.

■ **Automatic engine start function**

In the following situations, the engine may start even without the clutch pedal being depressed.

- The brake pedal is pumped or strongly depressed.
- Vehicles with an automatic air conditioning system: The air conditioning system is being used or turned on.
- Vehicles with an automatic air conditioning system: The windshield defogger is turned on.
- The battery is not sufficiently charged.
- The vehicle starts to roll on an incline.
- A large amount of electricity is being used.
- The driver's door is opened.
- The driver's seat belt is unfastened.
- The steering wheel is turned.

■ **Automatic reactivation of the Stop & Start system**

▶ Vehicles without smart entry & start system

Even if the Stop & Start system is disabled by the Stop & Start cancel switch, it will be automatically re-enabled once the engine switch is turned to the "LOCK" position then to the "START" position.

▶ Vehicles with smart entry & start system

Even if the Stop & Start system is disabled by the Stop & Start cancel switch, it will be automatically re-enabled once the engine switch is turned off then the engine is started.

■ **The Stop & Start system protection feature**

▶ Vehicles without smart entry & start system

When an excessively loud sound is being projected by the audio system, the audio system may be automatically cut off in order to maintain power for the Stop & Start system function.

If this occurs, turning the engine switch to the "LOCK" position then to the "ACC" or "ON" position re-enables the audio system.

▶ Vehicles with smart entry & start system

When an excessively loud sound is being projected by the audio system, the audio system may be automatically cut off in order to maintain power for the Stop & Start system function.

If this occurs, turning the "ENGINE START STOP" switch off then to ACCESSORY mode or IGNITION ON mode re-enables the audio system.

■ Steering wheel operation

When the engine is stopped by the Stop & Start system, the steering wheel may become heavier than when driving.

■ Hood

If the hood is opened while the engine is stopped by the Stop & Start system, the engine cannot be restarted by the Stop & Start system or by the automatic engine start function. Restart the engine with the engine switch operation. (→P. 198, 202)

■ When to use the Stop & Start system

Use the Stop & Start system when stopping the vehicle temporarily at red lights, intersections, etc. When stopping the vehicle for a longer period of time, turn off the engine completely.

■ Stop & Start system warning buzzer

If the engine is stopped by the Stop & Start system and the following action is performed, a buzzer will sound and the Stop & Start indicator will flash. This indicates that the engine is only stopped by the Stop & Start system, not that the engine has been turned off completely.

The shift lever is shifted to a position other than “N” with the clutch pedal released.

■ If the Stop & Start cancel indicator continues to flash

The Stop & Start system may be malfunctioning. Contact any authorized Toyota dealer or repairer, or another duly qualified and equipped professional.

■ If the windshield is fogged up while the engine is stopped by the Stop & Start system

- Vehicles with a manual air conditioning system: Restart the engine by depressing the clutch pedal (→P. 273) or by pressing the Stop & Start cancel switch, and then set the air outlet selection dial to . (→P. 305)

- Vehicles with an automatic air conditioning system: Turn the windshield defogger on. (The engine will start due to the automatic engine start function.) (→P. 314)

If the windshield fogs up frequently, press the Stop & Start cancel switch to deactivate the system.

■ **The Stop & Start system operation time and Stop & Start system total operation time display**

→P. 224

■ **Replacing battery**

The installed battery is specific to the Stop & Start system. It should only be replaced with a battery of identical type and rating.

Ask any authorized Toyota dealer or repairer, or another duly qualified and equipped professional for further details.

 **CAUTION**

■ **When the Stop & Start system is operating**

- Keep the shift lever in “N” and apply the brake pedal or parking brake for safety while the engine is stopped due to the Stop & Start system (while Stop & Start indicator is on).
Unexpected accidents may occur due to the automatic engine start function.
- Do not leave the vehicle while the engine is stopped due to the Stop & Start system (while Stop & Start indicator is on).
Unexpected accidents may occur due to the automatic engine start function.
- Ensure that the engine is not stopped by the Stop & Start system while the vehicle is in a poorly ventilated area. The engine may restart due to the automatic engine start function, causing exhaust gases to collect and enter the vehicle and resulting in death or a serious health hazard.

 NOTICE

■ **To ensure the system operates correctly**

If any one of the following situations occurs, the Stop & Start system may not operate correctly, thus, please have your vehicle checked by any authorized Toyota dealer or repairer, or another duly qualified and equipped professional.

- While the driver's seat belt is fastened, the driver's and front passenger's seat belt reminder light flashes.
- Even when the driver's seat belt is not fastened, the driver's and front passenger's seat belt reminder light remains off.
- Even when the driver's door is closed, the open door warning light comes on, or the interior light comes on when the interior light switch is in the door position.
- Even when the driver's door is opened, the open door warning light does not come on, or the interior light does not come on when the interior light switch is in the door position.

2-4. Using other driving systems

Driving assist systems

To help enhance driving safety and performance, the following systems operate automatically in response to various driving situations. Be aware, however, that these systems are supplementary and should not be relied upon too heavily when operating the vehicle.

■ ABS (Anti-lock Brake System)

Helps to prevent wheel lock when the brakes are applied suddenly, or if the brakes are applied while driving on a slippery road surface.

■ Brake assist

Generates an increased level of braking force after the brake pedal is depressed, when the system detects a panic stop situation.

■ VSC+ (Vehicle Stability Control +)

Provides cooperative control of the ABS, TRC, VSC and EPS. Helps to maintain directional stability when swerving on slippery road surfaces by controlling steering performance.

■ TRC (Traction Control)

Helps to maintain drive power and prevents the front wheels from spinning when starting the vehicle or accelerating on slippery roads.

■ EPS (Electric Power Steering)

Employs an electric motor to reduce the amount of effort needed to turn the steering wheel.

■ Hill-start assist control

Helps to prevent the vehicle from rolling backward when starting on an incline or slippery slope.

When the TRC and VSC+ are operating

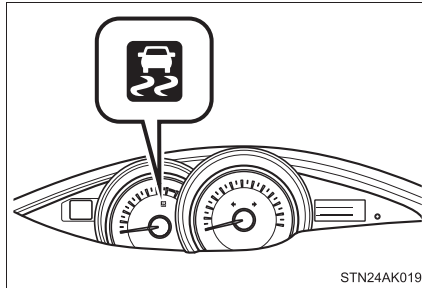

STN24AK019

If the vehicle is in danger of slipping or if the front wheels spin, the slip indicator light flashes to indicate that the TRC/VSC+ systems are operating.

To disable TRC and/or VSC+

If the vehicle gets stuck in fresh snow or mud, the TRC and VSC+ systems may reduce power from the engine to the wheels. You may need to turn the system off to enable you to rock the vehicle in order to free it.

■ **Turning off TRC**

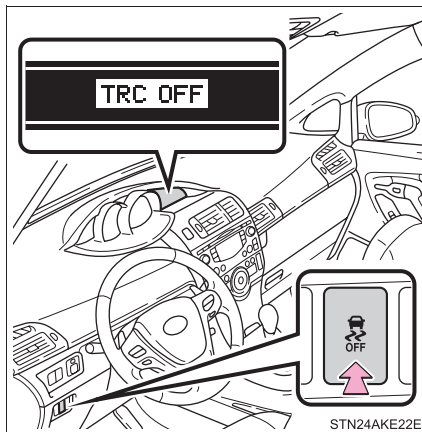

STN24AKE22E

Quickly push and release the button to turn off TRC.

A message will be shown on the multi-information display.

Push the button again to turn the system back on.

■ Turning off TRC and VSC+

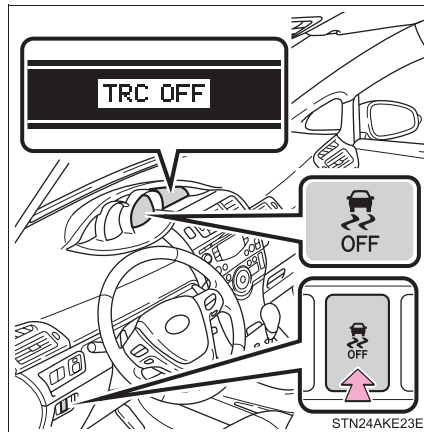

Push and hold the button for more than 3 seconds while the vehicle is stopped to turn off TRC and VSC+.

A message will be shown on the multi-information display and the VSC OFF indicator will come on.

Push the button again to turn the system back on.

■ Automatic reactivation of TRC and VSC+

▶ Vehicles without smart entry & start system

Turning the engine switch off after turning off the TRC and VSC+ systems will automatically re-enable them.

▶ Vehicles with smart entry & start system

Turning the “ENGINE START STOP” switch off after turning off the TRC and VSC+ systems will automatically re-enable them.

■ Automatic TRC reactivation

If only the TRC system is turned off, the TRC system will turn on when vehicle speed increases.

■ Automatic TRC and VSC+ reactivation

If the TRC and VSC+ systems are turned off, the systems will not turn on even when vehicle speed increases.

■ Sounds and vibrations caused by the ABS, brake assist, TRC, VSC+ and hill-start assist control systems

- A sound may be heard from the engine compartment when the engine is started or just after the vehicle begins to move. This sound does not indicate that a malfunction has occurred in any of these systems.
- Any of the following conditions may occur when the above systems are operating. None of these indicates that a malfunction has occurred.
 - Vibrations may be felt through the vehicle body and steering.
 - A motor sound may be heard after the vehicle comes to a stop.
 - The brake pedal may pulsate slightly after the ABS is activated.
 - The brake pedal may move down slightly after the ABS is activated.

■ EPS operation sound

When the steering wheel is operated, a motor sound (whirring sound) may be heard. This does not indicate a malfunction.

■ Operating conditions of hill-start assist control

When the following four conditions are met, the hill-start assist control will operate:

- On vehicles with a Multidrive, the shift lever is in a position other than “P” or “N” (when starting off forward/backward on an upward incline).
- The vehicle is stopped.
- The accelerator pedal is not depressed.
- The parking brake is not engaged.

■ Automatic system cancelation of hill-start assist control

The hill-start assist control will turn off in any of the following situations:

- On vehicles with a Multidrive, the shift lever is moved to “P” or “N”.
- The accelerator pedal is depressed.
- The parking brake is engaged.
- Approximately 2 seconds elapse after the brake pedal is released.

■ **Reduced effectiveness of the EPS system**

The effectiveness of the EPS system is reduced to prevent the system from overheating when there is frequent steering input over an extended period of time. The steering wheel may feel heavy as a result. Should this occur, refrain from excessive steering input or stop the vehicle and turn the engine off. The EPS system should return to normal after about 10 minutes.

■ **If the slip indicator light comes on...**

It may indicate a malfunction in the driving assist systems. Contact any authorized Toyota dealer or repairer, or another duly qualified and equipped professional.

 **CAUTION**

Any of the following conditions may result in an accident which could cause death or serious injury:

■ **The ABS does not operate effectively when**

- The limits of tire gripping performance have been exceeded (such as excessively worn tires on a snow covered road).
- The vehicle hydroplanes while driving at high speed on the wet or slick road.

■ **Stopping distance when the ABS is operating may exceed that of normal conditions**

The ABS is not designed to shorten the vehicle's stopping distance. Always maintain a safe distance from the vehicle in front of you, especially in the following situations:

- When driving on dirt, gravel or snow-covered roads
- When driving with tire chains
- When driving over bumps in the road
- When driving over roads with potholes or uneven roads

■ **TRC may not operate effectively when**

Directional control and power may not be achievable while driving on slippery road surfaces, even if the TRC is operating.
Do not drive the vehicle in conditions where stability and power may be lost.

⚠ CAUTION**■ Hill-start assist control does not operate effectively when**

- Do not overly rely on the hill-start assist control. The hill-start assist control may not operate effectively on steep inclines and roads covered with ice.
- Unlike the parking brake, hill-start assist control is not intended to hold the vehicle stationary for an extended period of time. Do not attempt to use hill-start assist control to hold the vehicle on an incline, as doing so may lead to an accident.

■ When the VSC+ is activated

The slip indicator light flashes. Always drive carefully. Reckless driving may cause an accident. Exercise particular care when the indicator light flashes.

■ When the TRC and VSC+ are off

Be especially careful and drive at a speed appropriate to the road conditions. As these are systems to help ensure vehicle stability and driving force, do not turn off TRC and VSC+ unless necessary.

■ Replacing tires

Make sure that all tires are of the same size, brand, tread pattern and total load capacity. In addition, make sure that the tires are inflated to the specified tire pressure level.

The ABS and VSC+ systems will not function correctly if different tires are fitted on the vehicle.

Contact any authorized Toyota dealer or repairer, or another duly qualified and equipped professional for further information when replacing tires or wheels.

■ Handling of tires and suspension

Using tires with any kind of problem or modifying the suspension will affect the driving assist systems, and may cause the system to malfunction.

2-5. Driving information

Cargo and luggage

Take notice of the following information about storage precautions, cargo capacity and load.

- Stow cargo and luggage in the luggage compartment whenever possible.
- Be sure all items are secured in place.
- Be careful to keep the vehicle level. Placing the weight as far forward as possible helps maintain vehicle balance.
- For better fuel economy, do not carry unnecessary weight.

■ Roof luggage carrier (if equipped)

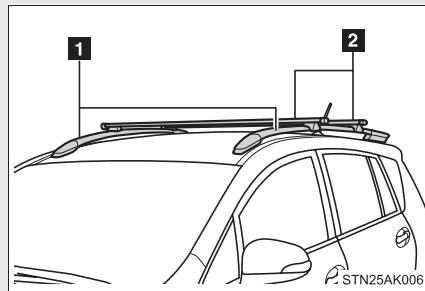

1 Roof rail

2 Cross rail

To use the roof rails as a roof luggage carrier, you must fit the roof rails with two or more genuine Toyota cross rails or their equivalent.

Follow the manufacturer's instructions and precautions when installing the cross rails or their equivalent.

⚠ CAUTION

■ Things that must not be carried in the luggage compartment

The following things may cause a fire if loaded in the luggage compartment.

- Receptacles containing gasoline
- Aerosol cans

⚠ CAUTION**■ Storage precautions**

Observe the following precautions.

Failing to do so may result in death or serious injury.

- Do not stack anything in the luggage compartment higher than the seat-backs.

Such items may be thrown about and possibly injure people in the vehicle in the event of sudden braking or in an accident.

- Do not place cargo or luggage in or on the following locations as the items may get under the clutch, brake or accelerator pedal and prevent the pedals from being depressed properly, block the driver's vision, or hit the driver or passengers, causing an accident.

- At the feet of the driver
- On the front passenger or rear seats (when stacking items)
- On the luggage cover
- On the instrument panel
- On the dashboard

- Secure all items in the occupant compartment, as they may shift and injure someone during sudden braking, sudden swerving or an accident.

- Never allow anyone to ride in the luggage compartment. It is not designed for passengers. They should ride in their seats with their seat belts properly fastened. Otherwise, they are much more likely to suffer death or serious bodily injury, in the event of sudden braking, sudden swerving or an accident.

■ Load and distribution

- Do not overload your vehicle.

- Do not apply loads unevenly.

Improper loading may cause deterioration of steering or braking control which may cause death or serious injury.

 CAUTION

■ **Roof luggage carrier precautions (if equipped)**

To use the roof rails as a roof luggage carrier, you must fit the roof rails with two or more genuine Toyota cross rails or their equivalent.

Follow the manufacturer's instructions and precautions when installing the cross rails or their equivalent.

When you load cargo on the roof luggage carrier, observe the following:

- Place the cargo so that its weight is distributed evenly between the front and rear axles.
- If loading long or wide cargo never exceed the vehicle overall length or width.
- Before driving, make sure the cargo is securely fastened on the roof luggage carrier.
- Loading cargo on the roof luggage carrier will make the center of the vehicle gravity higher. Avoid high speeds, sudden starts, sharp turns, sudden braking or abrupt maneuvers, otherwise it may result in loss of control or vehicle rollover due to failure to operate this vehicle correctly and result in death or serious injury.
- If driving for a long distance, on rough roads, or at high speeds, stop the vehicle now and then during the trip to make sure the cargo remains in its place.
- Do not exceed 100 kg (221 lb.) cargo weight on the roof rails. However, if the allowable cargo weight of the cross rails is under 100 kg (221 lb.) observe the load limit and other instructions for the cross rails.

2-5. Driving information

Winter driving tips

Carry out the necessary preparations and inspections before driving the vehicle in winter. Always drive the vehicle in a manner appropriate to the prevailing weather conditions.

■ Pre-winter preparations

- Use fluids that are appropriate to the prevailing outside temperatures.
 - Engine oil
 - Engine coolant
 - Washer fluid
- Have a service technician inspect the condition of the battery.
- Have the vehicle fitted with four snow tires or purchase a set of tire chains for the front tires.

Ensure that all tires are the same size and brand, and that chains match the size of the tires.

■ Before driving the vehicle

Perform the following according to the driving conditions:

- Do not try to forcibly open a window or move a wiper that is frozen. Pour warm water over the frozen area to melt the ice. Wipe away the water immediately to prevent it from freezing.
- To ensure proper operation of the climate control system fan, remove any snow that has accumulated on the air inlet vents in front of the windshield.
- Check for and remove any excess ice or snow that may have accumulated on the exterior lights, vehicle's roof, chassis, around the tires or on the brakes.
- Remove any snow or mud from the bottom of your shoes before getting in the vehicle.

■ **When driving the vehicle**

Accelerate the vehicle slowly, keep a safe distance between you and the vehicle ahead, and drive at a reduced speed suitable to road conditions.

■ **When parking the vehicle**

Park the vehicle and move the shift lever to “P” (Multidrive) or to “1” or “R” (manual transmission) without setting the parking brake. The parking brake may freeze up, preventing it from being released. If necessary, block the wheels to prevent inadvertent sliding or creeping.

Selecting tire chains

Use the correct tire chain size when mounting the tire chains. Chain size is regulated for each tire size.

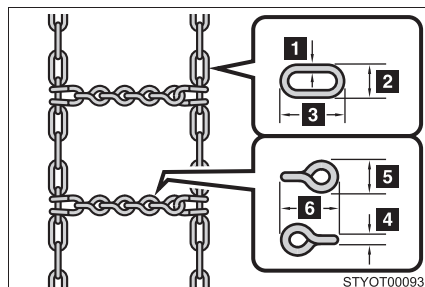

► Side chain

- 1 3 mm (0.12 in.) in diameter
- 2 10 mm (0.39 in.) in width
- 3 30 mm (1.18 in.) in length

► Cross chain

- 4 4 mm (0.16 in.) in diameter
- 5 14 mm (0.55 in.) in width
- 6 25 mm (0.98 in.) in length

Regulations on the use of tire chains

- Regulations regarding the use of tire chains vary according to location and type of road. Always check local regulations before installing chains.
- Install the chains on the front tires.
- Retighten the chains after driving 0.5 — 1.0 km (1/4 — 1/2 mile).

■ Tire chain installation

Observe the following precautions when installing and removing chains:

- Install and remove tire chains in a safe location.
- Install tire chains on the front tires only. Do not install the chains on the rear tires.
- Install tire chains on front tires as tightly as possible. Retighten chains after driving 0.5 — 1.0 km (1/4 — 1/2 mile).
- Install tire chains following the instructions provided with the tire chains.
- If wheel ornaments are used, they will be scratched by the chain band, so remove the ornaments before putting on the chains.

CAUTION

■ Driving with snow tires

Observe the following precautions to reduce the risk of accidents. Failing to do so may result in a loss of vehicle control and cause death or serious injury.

- Use tires of the size specified for your vehicle.
- Maintain the recommended level of tire inflation pressure.
- Do not drive at speeds in excess of the speed limit or the speed limit specified for the snow tires being used.
- Snow tires should be installed on all wheels.

 CAUTION

■ **Driving with tire chains**

Observe the following precautions to reduce the risk of accidents. Failing to do so may result in the vehicle being unable to be driven safely, and may cause death or serious injury.

- Do not drive in excess of the speed limit specified for the tire chains being used or 50 km/h (30 mph), whichever is lower.
- Avoid driving on bumpy road surfaces or over potholes.
- Avoid sudden acceleration, abrupt steering, sudden braking and shifting operations that cause sudden engine braking.
- Slow down sufficiently before entering a curve to ensure that vehicle control is maintained.

 NOTICE

■ **Repairing or replacing snow tires (vehicles with the tire pressure warning system)**

Request repairs or replacement of snow tires from Toyota dealers or legitimate tire retailers.

This is because the removal and attachment of snow tires affects the operation of the tire pressure warning valves and transmitters.

■ **Fitting tire chains (vehicles with the tire pressure warning system)**

The tire pressure warning valves and transmitters may not function correctly when tire chains are fitted.

2-5. Driving information

Trailer towing

Your vehicle is designed primarily as a passenger carrying vehicle. Towing a trailer will have an adverse effect on handling, performance, braking, durability, and fuel consumption. Your safety and satisfaction depend on the proper use of correct equipment and cautious driving habits. For your safety and the safety of others, do not overload the vehicle or trailer.

To tow a trailer safely, use extreme care and drive the vehicle in accordance with the trailer's characteristics and operating conditions.

Toyota warranties do not apply to damage or malfunction caused by towing a trailer for commercial purposes.

Ask your local authorized Toyota dealer or repairer, or another duly qualified and equipped professional, for further details before towing, as there are additional legal requirements in some countries.

■ Weight limits

Check the allowable towing capacity, GVM (Gross Vehicle Mass), MPAC (Maximum Permissible Axle Capacity), and permissible drawbar load before towing. (→P. 578)

■ Towing hitch/bracket

Toyota recommends the use of the Toyota hitch/bracket for your vehicle. Other products of a suitable nature and comparable quality may also be used.

Important points regarding trailer loads

■ Total trailer weight and permissible drawbar load

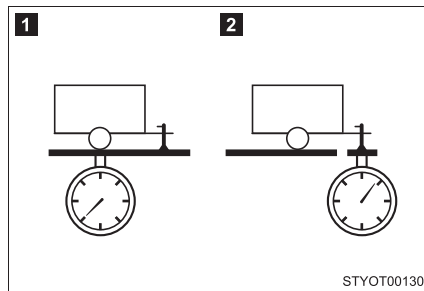

1 Total trailer weight

Weight of the trailer itself plus the trailer load should be within the maximum towing capacity. Exceeding this weight is dangerous. (→P. 578)

When towing a trailer, use a friction coupler or friction stabilizer (sway control device).

2 Permissible drawbar load

Allocate the trailer load so that the drawbar load is greater than 25 kg (55.1 lb.) or 4% of the towing capacity. Do not let the drawbar load exceed the indicated weight. (→P. 578)

■ Information tag (manufacturer's label)

TOYOTA MOTOR MANUFACTURING TURKEY INC.		CITRA
XXXXXXXXXXXXXXXXXXXX		ATM
XXXXXXXXXXXXXXXXXXXX		XXXX
XXXXXXXXXX kg		XXXX
1-	XXXXXXXXXX kg	XXXX
2-	XXXXXXXXXX kg	XXXX
MODEL XXXXXXXXXXXXXXXXXXXX XX XXX		

STS25AK001

- 1** Gross vehicle mass
- 2** Maximum permissible rear axle capacity
- 3** Gross combination vehicle mass

● Gross vehicle mass

▶ Vehicle category M1 models*

The combined weight of the driver, passengers, luggage, towing hitch, total curb mass and drawbar load should not exceed the gross vehicle mass by more than 100 kg (220.5 lb.). Exceeding this weight is dangerous.

▶ Vehicle category N1 models*

The combined weight of the driver, passengers, cargo, towing hitch, total curb mass and drawbar load must not exceed the gross vehicle mass. Exceeding this weight is dangerous.

● Maximum permissible rear axle capacity

▶ Vehicle category M1 models*

The weight borne by the rear axle should not exceed the maximum permissible rear axle capacity by 15% or more. Exceeding this weight is dangerous.

▶ Vehicle category N1 models*

The weight borne by the rear axle should not exceed the maximum permissible rear axle capacity. Exceeding this weight is dangerous.

The values for towing capacity were derived from testing conducted at sea level. Take note that engine output and towing capacity will be reduced at high altitudes.

● Gross combination vehicle mass

The sum of the total vehicle weight and the weight of the trailer being towed.

⚠ CAUTION

■ **Vehicle category M1 models*:** When the gross vehicle mass limit or maximum permissible axle capacity is exceeded

Do not exceed the established speed limit for towing a trailer in built-up areas or 100 km/h (62 mph), whichever is lower.

Failing to observe this precaution may lead to an accident causing death or serious injury.

*: To distinguish the vehicle category, ask any authorized Toyota dealer or repairer, or another duly qualified and equipped professional.

Installation positions* for the towing hitch/bracket and hitch ball

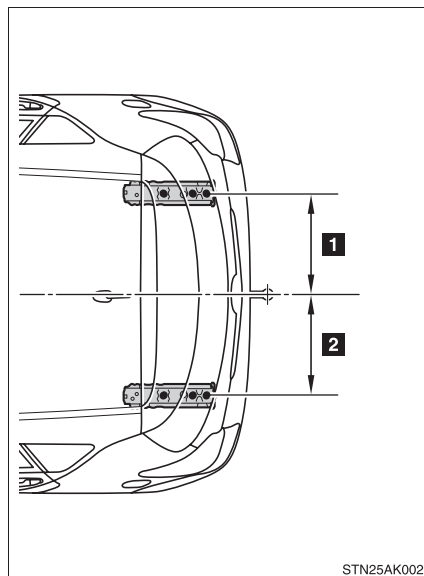

1 461 mm (18.1 in.)

2 461 mm (18.1 in.)

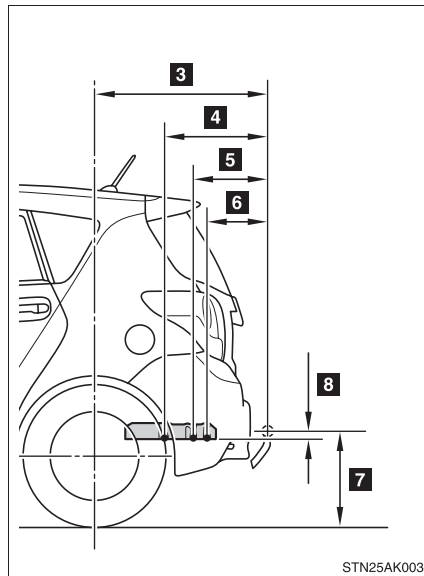

- 3 826 mm (32.5 in.)
- 4 497 mm (19.6 in.)
- 5 362 mm (14.3 in.)
- 6 297 mm (11.7 in.)
- 7 355 mm (14.0 in.)^{*1}
356 mm (14.0 in.)^{*1, 4}
365 mm (14.4 in.)^{*2}
369 mm (14.5 in.)^{*2, 4}
382 mm (15.0 in.)^{*1,3}
- 8 14 mm (0.6 in.)

- *: Gross vehicle mass and standard tire size
- *1: 205/60R16 tires
- *2: 215/55R17 tires
- *3: Vehicle category N1 models
- *4: For Russia

To distinguish the vehicle category, ask any authorized Toyota dealer or repairer, or another duly qualified and equipped professional.

2

When driving

■ Tire information

- Increase the tire inflation pressure to 20.0 kPa (0.2 kgf/cm² or bar, 3 psi) greater than the recommended value when towing. (→P. 595)
- Increase the air pressure of the trailer tires in accordance with the total trailer weight and according to the values recommended by the manufacturer of your trailer.

■ Trailer lights

Check that the turn signal lights and stoplights are operating correctly every time you hitch up the trailer. Directly wiring up to your vehicle may damage the electrical system and stop the lights from functioning correctly.

■ **Break-in schedule**

Toyota recommends that vehicles fitted with new power train components should not be used for towing trailers for the first 800 km (500 miles).

■ **Maintenance**

- Maintenance must be performed more frequently when using the vehicle for towing due to the greater weight burden placed on the vehicle compared to normal driving.
- Retighten all bolts securing the hitching ball and bracket after towing for approximately 1000 km (600 miles).

■ **Safety checks before towing**

- Check that the maximum load limit for the towing hitch/bracket and hitch ball is not exceeded. Bear in mind that the coupling weight of the trailer will add to the load exerted on the vehicle. Also make sure that the total load exerted on the vehicle is within the range of the weight limits. (→P. 294)
- Ensure that the trailer load is secure.
- Supplementary outside rear view mirrors should be added to the vehicle if the traffic behind cannot be clearly seen with standard mirrors. Adjust the extending arms of these mirrors on both sides of the vehicle so that they always provide maximum visibility of the road behind.

 **NOTICE**

■ **When the rear bumper strengthening material is aluminum**

Ensure the steel bracket part does not come directly in contact with that area.

When steel and aluminum come into contact, there is a reaction similar to corrosion, which will weaken the section concerned which may result in damage. Apply a rust inhibitor to parts that will come in contact when attaching a steel bracket.

Guidance

Your vehicle will handle differently when towing a trailer. In order to avoid accident, death or serious injury, keep the following in mind when towing:

■ Checking connections between trailer and lights

Stop the vehicle and check the operation of the connection between the trailer and lights after driving for a brief period as well as before setting off.

■ Practicing driving with a coupled trailer

- Get the feel for turning, stopping and reversing with the trailer coupled by practicing in an area with no or light traffic.
- When reversing with a coupled trailer, hold the section of the steering wheel nearest to you and rotate clockwise to turn the trailer left or counterclockwise to turn right. Always rotate gradually to prevent steering error. Have someone guide you when reversing to lessen the risk of accident.

■ Increasing vehicle-to-vehicle distance

At a speed of 10 km/h (6 mph), the distance to the vehicle running ahead of you should be equivalent to or greater than the combined length of your vehicle and trailer. Avoid sudden braking that may cause skidding. Otherwise, the vehicle may spin out of control. This is especially true when driving on wet or slippery road surfaces.

■ Sudden acceleration/steering input/cornering

Executing sharp turns when towing may result in the trailer colliding with your vehicle. Decelerate well in advance when approaching turns and take them slowly and carefully to avoid sudden braking.

■ **Important points regarding turning**

The wheels of the trailer will travel closer to the inside of the curve than the wheels of the vehicle. To make allowance for this, take the turns wider than you would normally.

■ **Important points regarding stability**

Vehicle movement resulting from uneven road surfaces and strong crosswinds will affect handling. The vehicle may also be rocked by passing buses or large trucks. Frequently check behind when moving alongside such vehicles. As soon as such vehicle movement occurs, immediately start to decelerate smoothly by slowly applying the brakes. Always steer the vehicle straight ahead while braking.

■ **Passing other vehicles**

Consider the total combined length of your vehicle and trailer, and ensure that the vehicle-to-vehicle distance is sufficient before executing lane changes.

■ **Transmission information**

▶ **Multidrive**

To maintain engine braking efficiency, when using engine braking, do not use the transmission in "D". Transmission shift gear position must be in "4" in the 7-speed sport sequential shiftmatic mode. (→P. 208)

▶ **Manual transmission**

To maintain engine braking efficiency, when using engine braking, do not use the transmission in "5" and "6" gear. (→P. 214)

■ **When towing a trailer, check the engine coolant temperature warning light (Red)**

Towing a loaded trailer up a long steep incline in temperatures exceeding 30°C (85°F) may result in the engine overheating.

If the engine coolant temperature warning light (Red) flashes or comes on, turn the air conditioning off immediately and stop the vehicle in a safe place. (→P. 569)

■ When parking the vehicle

Always place wheel chocks under the wheels of both the vehicle and trailer. Firmly set the parking brake and shift the shift lever to “P” (Multidrive), and “1” or “R” (manual transmission).

CAUTION

Follow all the instructions described in this section. Failure to do so could cause an accident resulting in death or serious injury.

■ Trailer towing precautions

When towing, make sure that none of the weight limits are exceeded. (→P. 294)

■ Before descending hills or long declines

Reduce speed and downshift. However, never downshift suddenly while descending steep or long downhill grades.

■ Operation of the brake

Do not hold the brake pedal depressed often or for long periods. Doing so may result in the brake overheating or reduce braking effects.

■ To avoid accident or injury

- Do not exceed 100 km/h (62 mph) or the posted towing speed limit, whichever is lower.
- Do not use cruise control when you are towing.
- Vehicles with a compact spare tire: Do not tow a trailer when the compact spare tire is installed on your vehicle.
- Vehicles with an emergency tire puncture repair kit: Do not tow a trailer when the tire installed is repaired with the emergency tire puncture repair kit.

2-5. Driving information

3-1. Using the air conditioning system and defogger

Manual air conditioning system	304
Automatic air conditioning system	310
Power heater	317
Rear window and outside rear view mirror defoggers	319

3-2. Using the audio system

Audio system types	321
Using the radio	323
Using the CD player	327
Playing back MP3 and WMA discs.....	332
Operating an iPod.....	338
Operating a USB memory.....	345
Optimal use of the audio system	352
Using the AUX port.....	354
Using the steering wheel audio switches	355

3-3. Using the interior lights

Interior lights list.....	358
• Personal/interior lights main switch	359
• Personal/interior lights	360

3-4. Using the storage features

List of storage features	362
• Glove box	363
• Console box.....	364
• Overhead console	366
• Cup holders	366
• Bottle holders.....	368
• Auxilliary boxes	369

3-5. Other interior features

Sun visors	371
Vanity mirrors.....	372
Conversation mirror	373
Power outlets	374
Seat heaters	376
Armrests	378
Front seatback tables	379
Rear side sunshades	381
Assist grips	382
Floor mat.....	383
Luggage compartment features.....	385

3-1. Using the air conditioning system and defogger Manual air conditioning system*

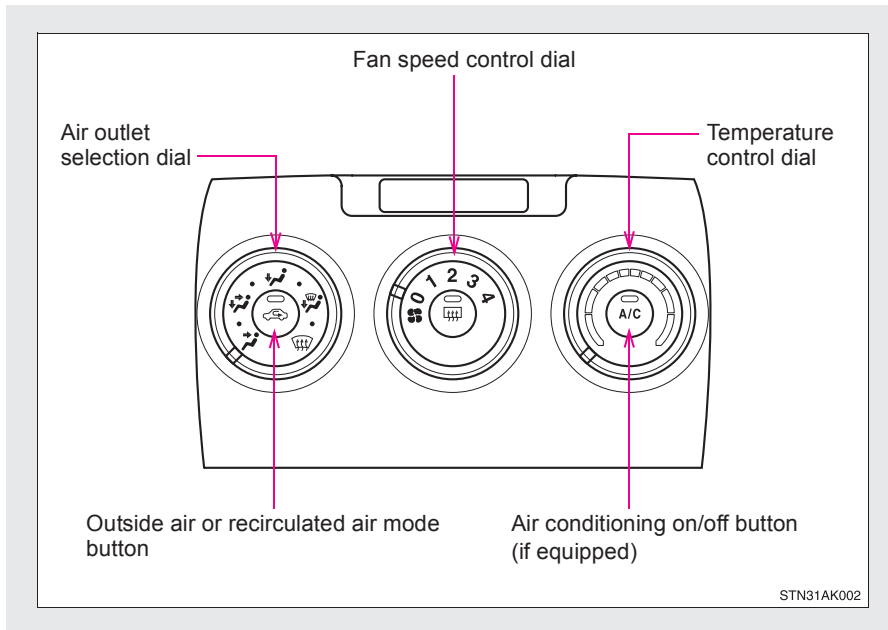

Adjusting the settings

■ Adjusting the temperature setting (vehicles without air conditioning system)

Turn the temperature control dial clockwise to increase the temperature.

■ Adjusting the temperature setting (vehicles with air conditioning system)

Turn the temperature control dial clockwise (warm) or counter-clockwise (cool).

If  is not pressed, the system will blow ambient temperature air or heated air.

*: If equipped

■ **Adjusting the fan speed**

Turn the fan speed control dial clockwise (increase) or counter clockwise (decrease).

Set the dial to "0" to turn the fan off.

■ **Changing the air outlets**

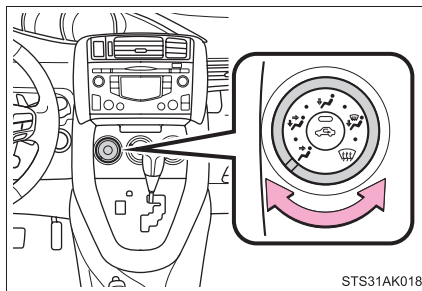

Turn the air outlet selection dial.

The air outlets switch each time either side of air outlet selection dial is turned.

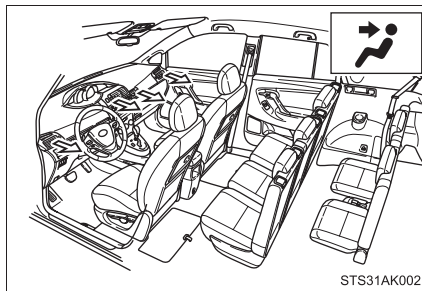

Air flows to the upper body.

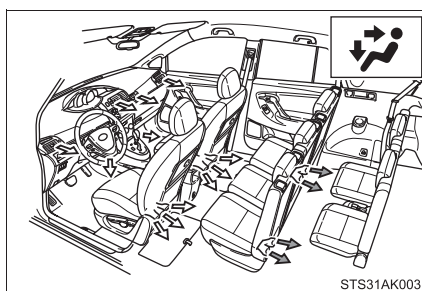

Air flows to the upper body and feet.

⇒: Some models

3-1. Using the air conditioning system and defogger

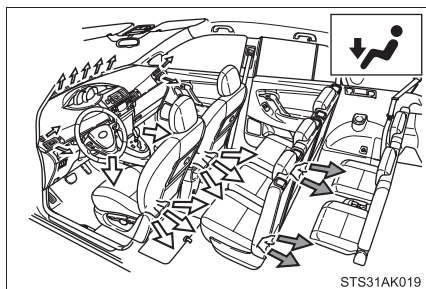

Air flows mainly to the feet.

⇒: Some models

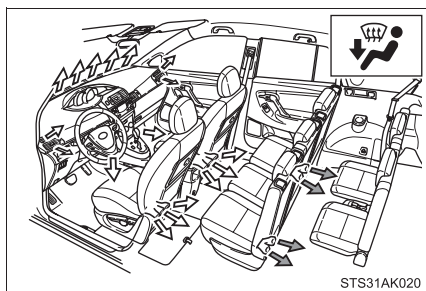

Air flows to the feet and the windshield defogger operates.

⇒: Some models

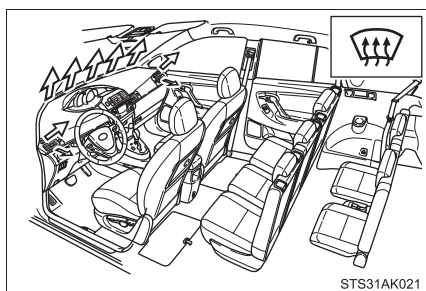

Air flows to the windshield and side windows.

The air intake is automatically switched to outside air mode.

■ Switching between outside air and recirculated air modes

Press .

The mode switches between outside air mode (indicator off) and recirculated air mode (indicator on) each time  is pressed.

Adjusting the position of and opening and closing the air outlets

► Center outlets

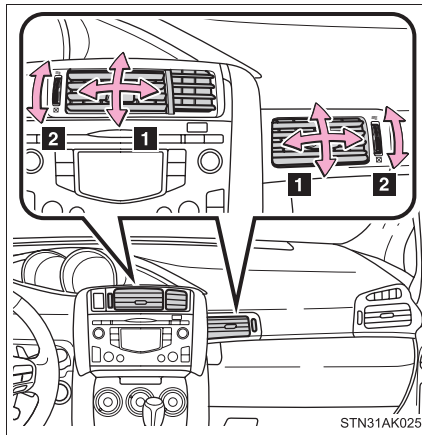

- 1 Direct air flow to the left or right, up or down.
- 2 Turn the knob to open or close the vent.

► Right and left side outlets

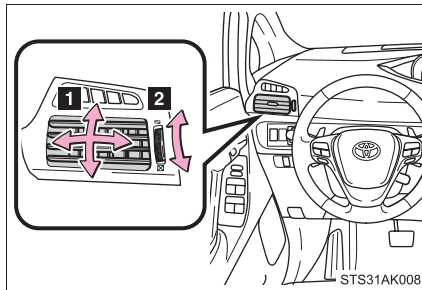

- 1 Direct air flow to the left or right, up or down.
- 2 Turn the knob to open or close the vent.

■ **Using the system in recirculated air mode**

The windows will fog up more easily if the recirculated air mode is used for an extended period.

■ **When outside air temperature approaches 0°C (32°F) (vehicles with air conditioning system)**

The air conditioning system may not operate even when  is pressed.

■ **When  is selected for the air outlets used**

For your driving comfort, air flowing to the feet may be warmer than air flowing to the upper body depending on the position of the temperature adjustment dial.

■ **Ventilation and air conditioning odors**

- To let fresh air in, set the air conditioning system to the outside air mode.
- During use, various odors from inside and outside the vehicle may enter into and accumulate in the air conditioning system. This may then cause odor to be emitted from the vents.
- To reduce potential odors from occurring:
It is recommended that the air conditioning system be set to outside air mode prior to turning the vehicle off.

 CAUTION

■ **To prevent the windshield from fogging up**

Do not set the air outlet selection dial to  during cool air operation in extremely humid weather. The difference between the temperature of the outside air and that of the windshield can cause the outer surface of the windshield to fog up, blocking your vision.

 NOTICE

■ **To prevent battery discharge**

Do not leave the air conditioning system on longer than necessary when the engine is stopped.

3-1. Using the air conditioning system and defogger Automatic air conditioning system*

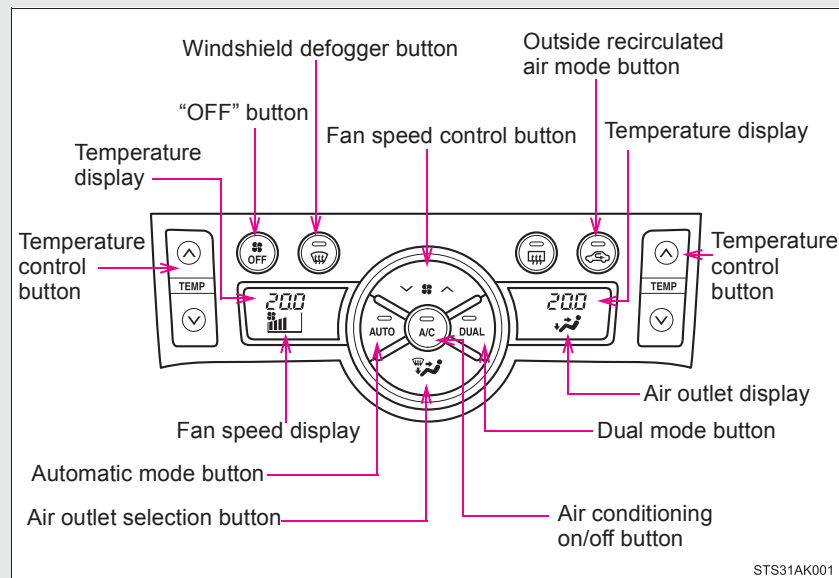

Airflow and outlets are automatically adjusted according to the temperature setting.



Using the automatic mode

STEP 1 Press  .

The air conditioning system will begin to operate. Air outlets and fan speed are automatically adjusted according to the temperature setting.

STEP 2 Press "∧" to increase the temperature and "∨" to decrease the temperature on  (left-hand drive vehicles) or  (right-hand drive vehicles) on the driver side.

The temperature for the driver and front passenger seats can be set separately. (→P. 311)



*: If equipped

■ **Automatic mode indicator**



If the fan speed setting or air flow modes are operated, the automatic mode indicator goes off. However, automatic mode for functions other than that operated are maintained.

Adjusting the settings

■ **Adjusting the temperature setting**

Press “^” to increase the temperature and “v” to decrease the temperature on  (left-hand drive vehicles) or  (right-hand drive vehicles) on the driver side.

Press “^” (increase) or “v” (decrease) on  (left-hand drive vehicles)

or  (right-hand drive vehicles) on the passenger side to separately adjust the temperature for the passenger and driver sides (individual mode). Press  to return the driver and passenger side temperatures to the same setting (simultaneous mode).

The air conditioning system switches between individual and simultaneous modes each time  is pressed.

■ **Adjusting the fan speed**

Press “v” (decrease) or “^” (increase) on .

The fan speed is shown on the display. (7 levels)

Press  to turn the fan off.

3-1. Using the air conditioning system and defogger

■ Changing the air outlets

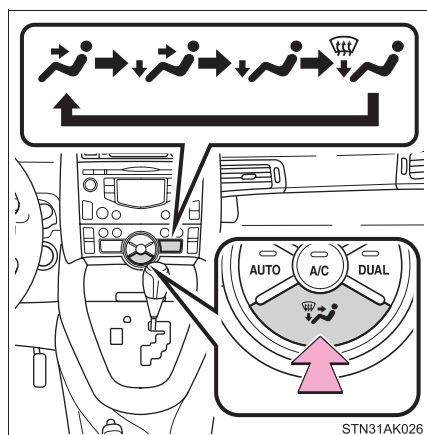

Press .

The air outlets switch each time

 is pressed.

Air flow as shown according to the mode selected.

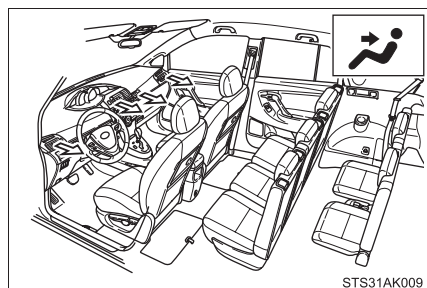

Air flows to the upper body.

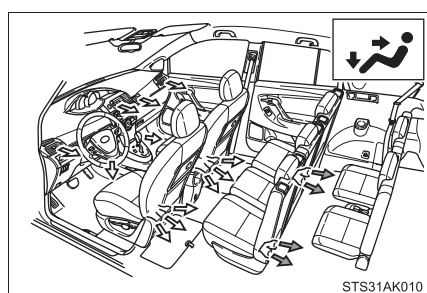

Air flows to the upper body and feet.

➡: Some models

3-1. Using the air conditioning system and defogger

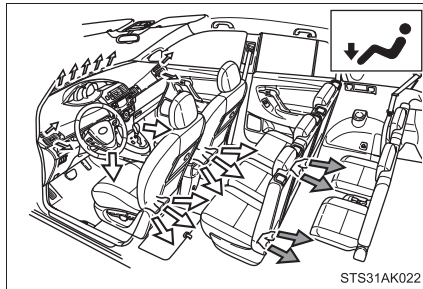

Air flows mainly to the feet.

⇒: Some models

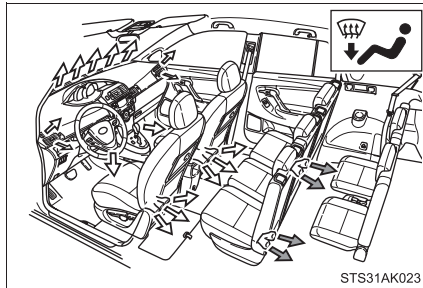

Air flows to the feet and the windshield defogger operates.

⇒: Some models

■ Switching between outside air and recirculated air modes

Press .

The mode switches between outside air mode (indicator off) and recirculated air mode (indicator on) each time  is pressed.

3-1. Using the air conditioning system and defogger

Defogging the windshield

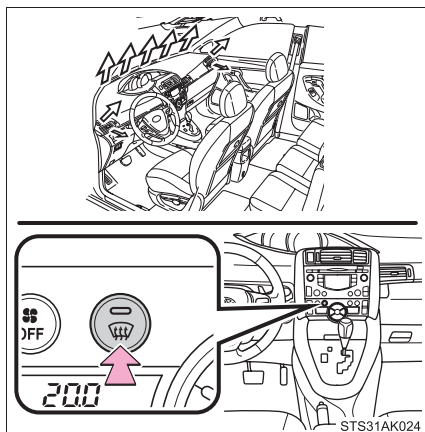

Press .

The indicator comes on.

The air conditioning system control operates automatically.

If the outside temperature is 5°C (41°F) or below, recirculated air mode will automatically switch to outside air mode.

Adjusting the position of and opening and closing the air outlets

► Center outlets

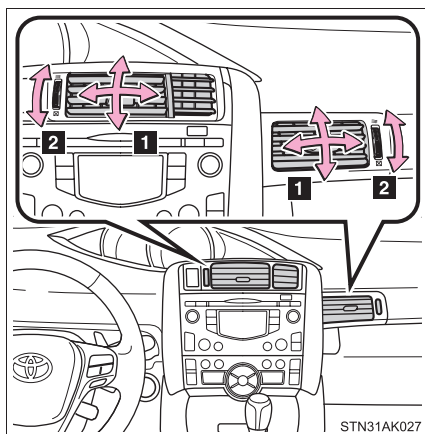

1 Direct air flow to the left or right, up or down.

2 Turn the knob to open or close the vent.

► Right and left side outlets

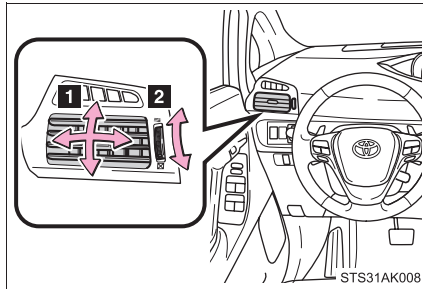

- 1 Direct air flow to the left or right, up or down.
- 2 Turn the knob to open or close the vent.

■ Using the automatic mode

Fan speed is adjusted automatically in accordance with the temperature setting and ambient conditions. As a result, the following may occur.

- The system may switch automatically to recirculated air mode when the coolest temperature setting is selected in summer.
- Immediately after  is pressed, the fan may stop for a while until warm or cool air is ready to flow.
- Cool air may flow to the area around the upper body when the heater is on.

■ Using the system in recirculated air mode

The windows will fog up more easily if the recirculated air mode is used for an extended period.

■ Window defogger feature

Recirculated air mode may automatically switch to outside air mode in situations where the windows need to be defogged.

■ When outside temperature approaches 0°C (32°F)

The air conditioning system may not operate even when  is pressed.

■ When  is selected for the air outlets used

For your driving comfort, air flowing to the feet may be warmer than air flowing to the upper body depending on the position of the temperature adjustment dial.

3-1. Using the air conditioning system and defogger

■ Ventilation and air conditioning odors

- To let fresh air in, set the air conditioning system to the outside air mode.
- During use, various odors from inside and outside the vehicle may enter into and accumulate in the air conditioning system. This may then cause odor to be emitted from the vents.
- To reduce potential odors from occurring:
 - It is recommended that the air conditioning system be set to outside air mode prior to turning the vehicle off.
 - The start timing of the blower may be delayed for a short period of time immediately after the air conditioning system is started in AUTO mode.

CAUTION

■ To prevent the windshield from fogging up

Do not use  during cool air operation in extremely humid weather. The difference between the temperature of the outside air and that of the windshield can cause the outer surface of the windshield to fog up, blocking your vision.

NOTICE

■ To prevent battery discharge

Do not leave the air conditioning system on longer than necessary when the engine is stopped.

3-1. Using the air conditioning system and defogger Power heater*

This feature is used to keep the cabin warm in cold conditions.

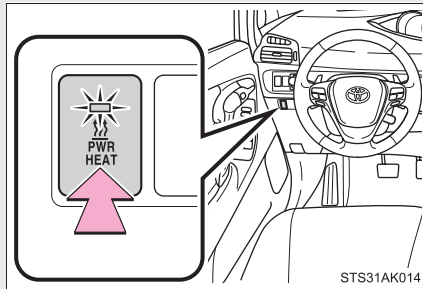

Turns the power heater on/off

The power heater turns on about 30 seconds after the switch is pressed.

■ Power heater can be operated when

- The engine is running.
- The engine coolant temperature is low.

■ Normal characteristics of power heater operation

The following cases do not indicate a malfunction.

- When the power heater is turned on or off, some white smoke and a slight odor may be emitted from the power heater exhaust that is located under the floor.
- When the power heater is used under extremely cold conditions, vapor may be visible from its exhaust.
- When the power heater is turned off, you may hear a sound in the engine compartment for about 2 minutes until the power heater turns off completely.

■ After the heater is turned off

We recommend not restarting the heater for 10 minutes after you turn it off. Otherwise, a noise may be heard as the heater ignites.

■ When refueling your vehicle

The engine must be turned off. Turning the engine off turns the power heater off.

*: If equipped

⚠ CAUTION

■ To prevent burns or damage to your vehicle

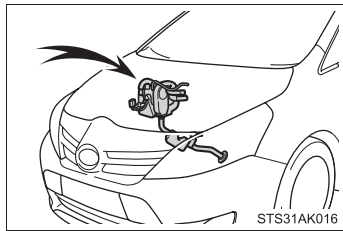

- Do not touch the heater or its exhaust pipe as they are hot. You may burn yourself.
- Keep flammable items such as fuel away from the heater and its exhaust pipe, as this may cause a fire.

⚠ NOTICE

■ To prevent damage to your vehicle

- Do not turn the heater on and off repeatedly in 5 minute intervals as this can shorten the life of the heater components. If the engine must be turned on and off repeatedly within short intervals (such as when the vehicle is being used for delivery purposes), turn the heater off.
- Do not modify or open the heater without consulting any authorized Toyota dealer or repairer, or another duly qualified and equipped professional, as this may cause a heater malfunction or a fire.
- Be careful not to splash water or spill liquid directly on the heater or on the heater fuel pump, as this may cause the heater to malfunction.
- Keep the intake and exhaust pipes of the heater free from water, snow, ice, mud, etc. If the pipes become clogged, this can cause the heater to malfunction.
- If you notice anything unusual, such as a fluid leak, smoke or poor operation, turn off the heater and have your vehicle checked by any authorized Toyota dealer or repairer, or another duly qualified and equipped professional.

3-1. Using the air conditioning system and defogger Rear window and outside rear view mirror defoggers

Defoggers are used to defog the rear window, and to remove rain-drops, dew and frost from the outside rear view mirrors.

► Vehicles with manual air conditioning system

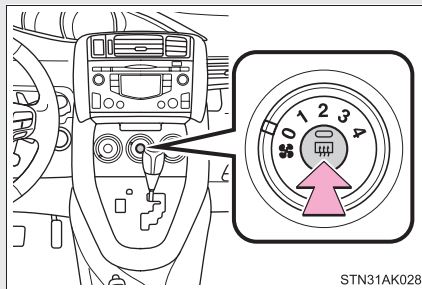

Turns the defoggers on/off

The defoggers will automatically turn off after approximately 15 minutes.

► Vehicles with automatic air conditioning system

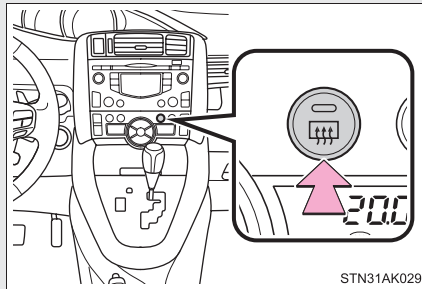

Turns the defoggers on/off

The defoggers will automatically turn off the operation time. The operation time is between 15 minutes and 1 hour depending on the ambient temperature and vehicle speed.

3-1. Using the air conditioning system and defogger

■ The defoggers can be operated when

▶ Vehicles without smart entry & start system

The engine switch is in the "ON" position.

▶ Vehicles with smart entry & start system

The "ENGINE START STOP" switch is in IGNITION ON mode.

■ The outside rear view mirror defoggers

Turning the rear window defogger on will turn the outside rear view mirror defoggers on.

CAUTION

■ When the outside rear view mirror defoggers are on

Do not touch the outside surface of the rear view mirrors, as they can become very hot and burn you.

3-2. Using the audio system

Audio system types*

► Vehicles with Navigation/Multimedia system

Owners of models equipped with a Navigation/Multimedia system should refer to the “Navigation and multimedia system Owner’s Manual”.

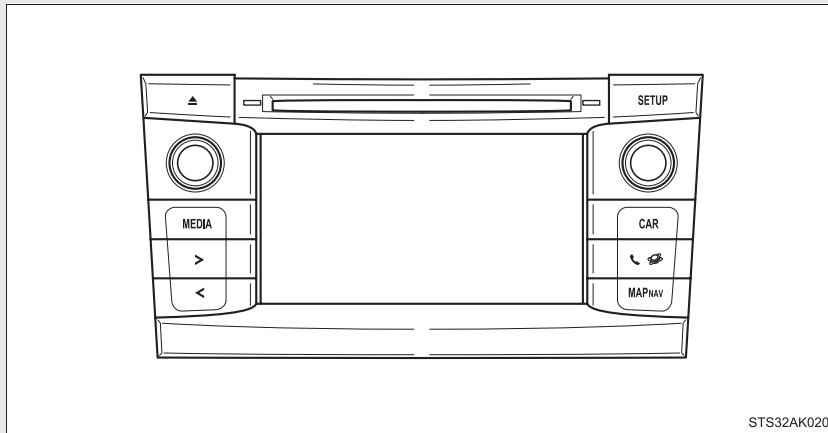

► Vehicles without Navigation/Multimedia system

CD player and AM/FM radio

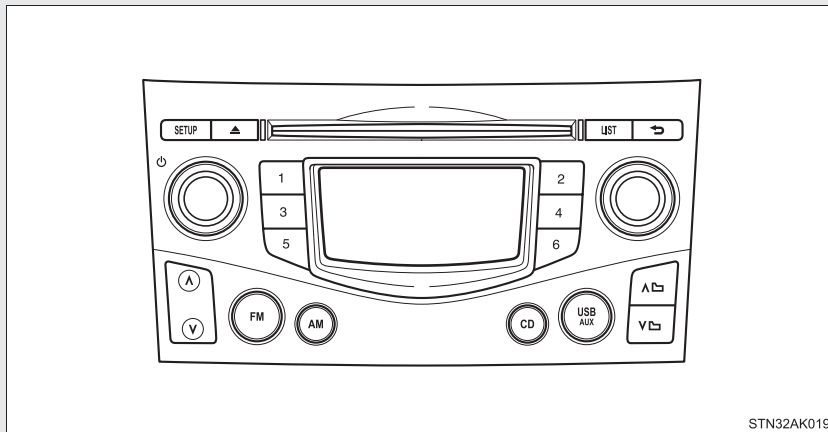

*: If equipped

3-2. Using the audio system

Title	Page
Using the radio	P. 323
Using the CD player	P. 327
Playing back MP3 and WMA discs	P. 332
Operating an iPod	P. 338
Operating a USB memory	P. 345
Optimal use of the audio system	P. 352
Using the AUX port	P. 354
Using the steering wheel audio switches	P. 355

■ Using cellular phones

Interference may be heard through the audio system's speakers if a cellular phone is being used inside or close to the vehicle while the audio system is operating.

NOTICE

■ To prevent battery discharge

Do not leave the audio system on longer than necessary when the engine is stopped.

■ To avoid damaging the audio system

Take care not to spill drinks or other fluids over the audio system.

■ To prevent damage to USB memory or its terminal

Depending on the size and shape of the USB memory that is connected to the system, the passenger's seat may hit the USB memory when moving the seat forward. In this case, do not forcibly move the seat forward as this may damage the USB memory or the terminal, etc.

3-2. Using the audio system

Using the radio*

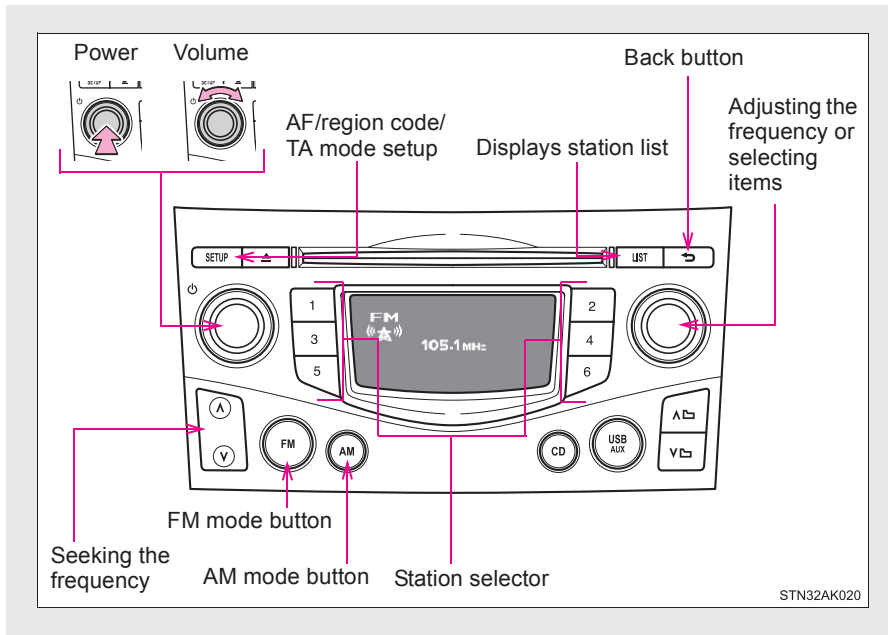

3



Interior features

Setting station presets

In AF-ON mode the radio changes frequency to the strongest signal of the selected station.

STEP 1 Search for desired stations by turning  or pressing “^” or

“v” on .

STEP 2 Press and hold the button (from  to ) the station is to be set to until you hear a beep.

*: If equipped

Using the station list

■ Updating the station list

STEP 1 Press  .

The station list will be displayed.

STEP 2 Press  (Update) to update the list.

“Updating” is displayed while the searching is in process, and then available stations will be listed on the display.

To cancel the updating process, press  .

■ Selecting a station from the station list

STEP 1 Press  .

The station list will be displayed.

STEP 2 Turn  to select a station.

STEP 3 Press  to tune in the station.

To return to the previous display, press  .

RDS (Radio Data System)

This feature allows your radio to receive station.

■ Listening to stations of the same network

STEP 1 Press  .

STEP 2 Turn  to “RADIO” and press .

STEP 3 Turn  as corresponds to the desired mode: “FM AF” or “Region code”.

STEP 4 Press  to select “ON” or “OFF”.

FM AF ON mode: The station among those of the same network with strong reception is selected.

Region code ON mode: The station among those of the same network with strong reception and broadcasting the same program is selected.

■ **Traffic information**

STEP 1 Press  .

STEP 2 Turn  to “RADIO” and press .

STEP 3 Turn  to “FM TA” mode.

STEP 4 Press  to select “ON” or “OFF”.

TP mode: The system automatically switches to traffic information when a broadcast with a traffic information signal is received.

The station returns to the previous one when the traffic information ends.

■ **EON (Enhanced Other Network) system (for traffic announcement function)**

If the RDS station (with EON data) you are listening to is not broadcasting a traffic information program and the audio system is in the TA (traffic announcement) mode, the radio will be switched automatically to a station broadcasting a traffic information program in the EON AF list when traffic information begins.

■ **When the battery is disconnected**

Stations presets are erased.

■ **Reception sensitivity**

- Maintaining perfect radio reception at all times is difficult due to the continually changing position of the antenna, differences in signal strength and surrounding objects, such as trains, transmitters, etc.
- The radio antenna is mounted on the rear roof. The antenna can be removed from the base by turning it.

 **NOTICE**

■ **To prevent damage, remove the antenna in the following cases**

- The antenna will touch the ceiling of a garage.
- A cover will be put on the roof.

3-2. Using the audio system Using the CD player*

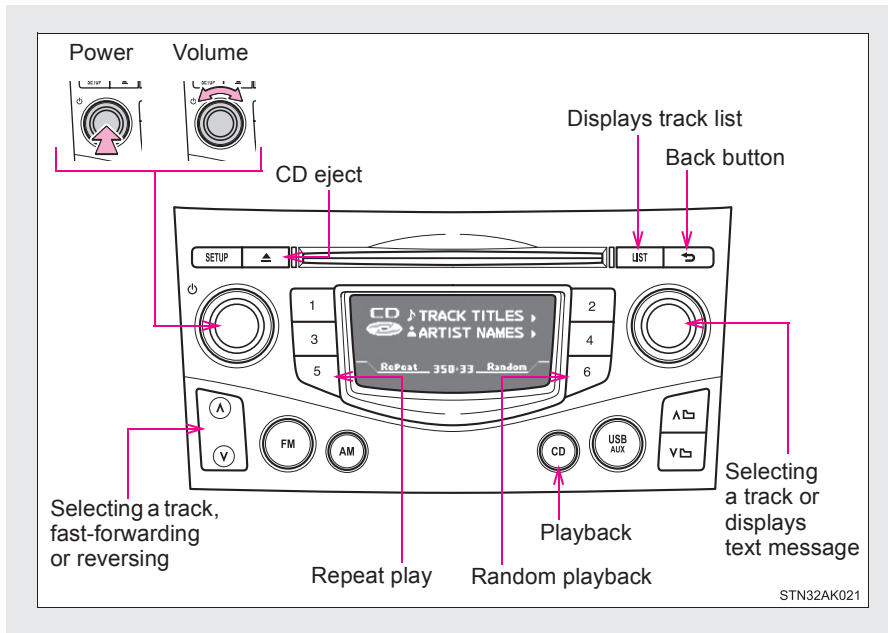

3

Interior features



Loading CDs

Insert a CD.

Ejecting CDs

Press  and remove the CD.

Selecting a track

Turn  or press “^” to move up or “v” to move down using  until the desired track number is displayed.

*: If equipped

327

Selecting a track from a track list

STEP 1 Press  .

The track list will be displayed.

STEP 2 Turn and press  to select a track.

To return to the previous display, press  or  .

Fast-forwarding and reversing tracks

To fast-forward or reverse, press and hold “^” or “v” on  .

Random playback

Press  (Random).

To cancel, press  (Random) again.

Repeat play



Press  (Repeat).

To cancel, press  (Repeat) again.

Switching the display

Press  .

Track title, Artist name and CD title are shown on the display.

To return to the previous display, press  or  .

■ Display

Up to 24 characters can be displayed.

Depending on the contents recorded, the characters may not be displayed properly or may not be displayed at all.

■ Error messages

“ERROR”: This indicates a problem either in the CD or inside the player.

“CD CHECK”: The CD may be dirty, damaged or inserted up-side down.

“WAIT”: Operation has stopped due to a high temperature inside the player. Wait for a while and then press . If the CD still cannot be played back, contact any authorized Toyota dealer or repairer, or another duly qualified and equipped professional.

■ Discs that can be used

Discs with the marks shown below can be used.

Playback may not be possible depending on recording format or disc features, or due to scratches, dirt or deterioration.



CDs with copy-protect features may not be used.

■ CD player protection feature

To protect the internal components, playback is automatically stopped when a problem is detected while the CD player is being used.

■ If a CD is left inside the CD player or in the ejected position for extended periods

The CD may be damaged and may not play properly.

■ Lens cleaners

Do not use lens cleaners. Doing so may damage the CD player.

⚠ CAUTION

■ Certification for the CD player

This product is a class I laser product.

- Do not open the cover of the player or attempt to repair the unit yourself. Refer servicing to qualified personnel.
- Laser power: No hazardous

⚠ NOTICE

■ CDs and adapters that cannot be used

Do not use the following types of CDs.

Also, do not use 8 cm (3 in.) CD adapters, DualDiscs or printable discs. Doing so may damage the player and/or the CD insert/eject function.

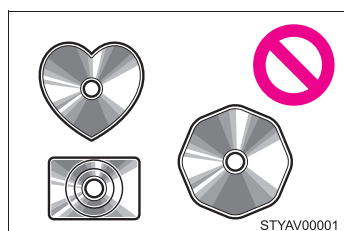

- CDs that have a diameter that is not 12 cm (4.7 in.)

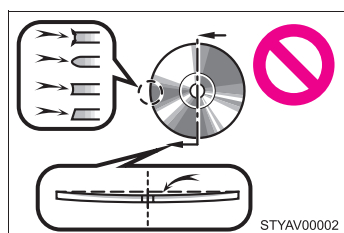

- Low-quality and deformed CDs

 NOTICE

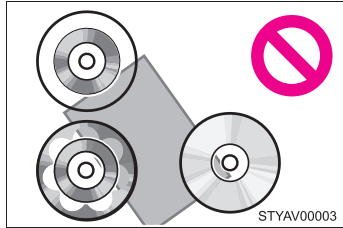

● CDs with a transparent or translucent recording area

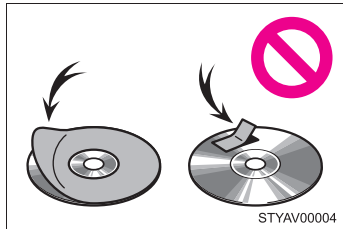

● CDs that have had tape, stickers or CD-R labels attached to them, or that have had the label peeled off

■ **CD player precautions**

Failure to follow the precautions below may result in serious damage to the CDs or the player itself.

- Do not insert anything other than CDs into the CD slot.
- Do not apply oil to the CD player.
- Store CDs away from direct sunlight.
- Never try to disassemble any part of the CD player.

3-2. Using the audio system

Playing back MP3 and WMA discs*

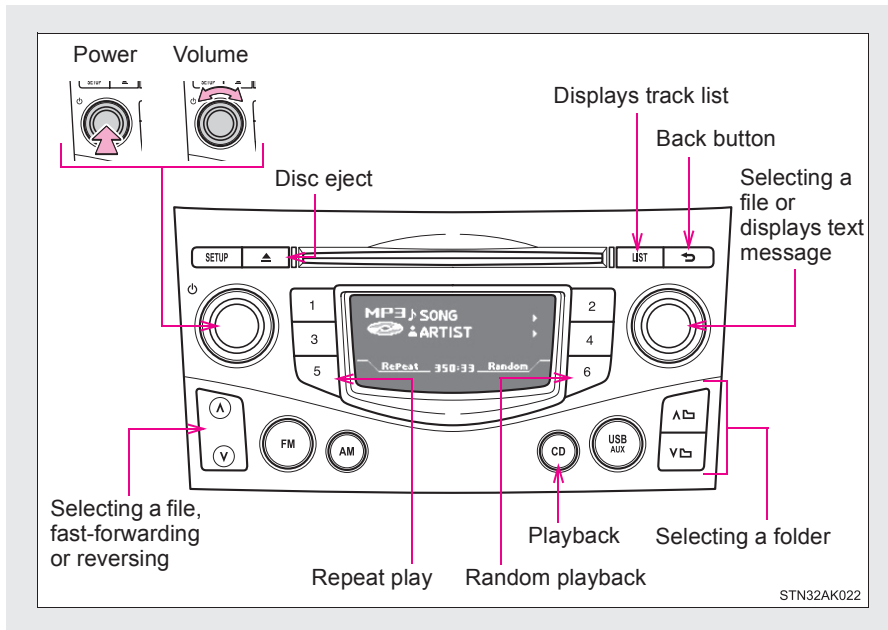

Loading and ejecting MP3 and WMA discs

→P. 327

Selecting a folder

■ Selecting folders one at a time

Press “^” or “v” on  to select the desired folder.

*: If equipped

■ Selecting a folder and file from folder list

STEP 1 Press  .

The folder list will be displayed.

STEP 2 Turn and press  to select a folder and a file.



To return to the previous display, press  .

To exit, press  .

■ Returning to the first folder

Press and hold “√” on  until you hear a beep.

Selecting files

Turn  or press “∧” or “√” on  to select the desired file.

Fast-forwarding and reversing files

To fast-forward or reverse, press and hold “∧” or “√” on  .

Random playback

Pressing  (Random) changes modes in the following order:
Folder random → Disc random → Off

Repeat play



Pressing  (Repeat) changes modes in the following order:
File repeat → Folder repeat* → Off

*: Available except when Random (random playback) is selected

Switching the display

Press .

Track title, Artist name and Album title (MP3 only) are shown on the display.

To return to the previous display, press  or .

■ Display

→P. 329

■ Error messages

“ERROR”: This indicates a problem either in the CD or inside the player.

“CD CHECK”: The CD may be dirty, damaged or inserted up-side down.

“NO SUPPORT”: This indicates that the MP3/WMA file is not included in the CD.

■ Discs that can be used

Discs with the marks shown below can be used.

Playback may not be possible depending on recording format or disc features, or due to scratches, dirt or deterioration.



■ CD player protection feature

To protect the internal components, playback is automatically stopped when a problem is detected while the CD player is being used.

■ If a CD is left inside the CD player or in the ejected position for extended periods

The CD may be damaged and may not play properly.

■ Lens cleaners

Do not use lens cleaners. Doing so may damage the CD player.

■ MP3 and WMA files

MP3 (MPEG Audio LAYER3) is a standard audio compression format.

Files can be compressed to approximately 1/10 of their original size by using MP3 compression.

WMA (Windows Media Audio) is a Microsoft audio compression format.

This format compresses audio data to a size smaller than that of the MP3 format.

There is a limit to the MP3 and WMA file standards and to the media/formats recorded by them that can be used.

● MP3 file compatibility

- Compatible standards
MP3 (MPEG1 LAYER3, MPEG2 LSF LAYER3)
- Compatible sampling frequencies
MPEG1 LAYER3: 32, 44.1, 48 (kHz)
MPEG2 LSF LAYER3: 16, 22.05, 24 (kHz)
- Compatible bit rates (compatible with VBR)
MPEG1 LAYER3: 64, 80, 96, 112, 128, 160, 192, 224, 256, 320 (kbps)
MPEG2 LSF LAYER3: 64, 80, 96, 112, 128, 144, 160 (kbps)
- Compatible channel modes: stereo, joint stereo, dual channel and monaural

● WMA file compatibility

- Compatible standards
WMA Ver. 7, 8, 9
- Compatible sampling frequencies
32, 44.1, 48 (kHz)
- Compatible bit rates (only compatible with 2-channel playback)
Ver. 7, 8: CBR 48, 64, 80, 96, 128, 160, 192 (kbps)
Ver. 9: CBR 48, 64, 80, 96, 128, 160, 192, 256, 320 (kbps)

● Compatible media

Media that can be used for MP3 and WMA playback are CD-Rs and CD-RWs.

Playback in some instances may not be possible, depending on the status of the CD-R or CD-RW. Playback may not be possible or the audio may jump if the disc is scratched or marked with fingerprints.

3-2. Using the audio system

● Compatible disc formats

The following disc formats can be used.

- Disc formats: CD-ROM Mode 1 and Mode 2
CD-ROM XA Mode 2, Form 1 and Form 2
- File formats: ISO9660 Level 1, Level 2, (Romeo, Joliet)
MP3 and WMA files written in any format other than those listed above may not play correctly, and their file names and folder names may not be displayed correctly.

Items related to standards and limitations are as follows.

- Maximum directory hierarchy: 8 levels
- Maximum length of folder names/file names: 32 characters
- Maximum number of folders: 192 (including the root)
- Maximum number of files per disc: 255

● File names

The only files that can be recognized as MP3/WMA and played are those with the extension .mp3 or .wma.

● Multi-sessions

As the audio system is compatible with multi-sessions, it is possible to play discs that contain MP3 and WMA files. However, only the first session can be played.

● ID3 and WMA tags

ID3 tags can be added to MP3 files, making it possible to record the track title and artist name, etc.

The system is compatible with ID3 Ver. 1.0, 1.1, and Ver. 2.2, 2.3 ID3 tags. (The number of characters is based on ID3 Ver. 1.0 and 1.1.)

WMA tags can be added to WMA files, making it possible to record the track title and artist name in the same way as with ID3 tags.

● MP3 and WMA playback

When a disc containing MP3 or WMA files is inserted, all files on the disc are first checked. Once the file check is finished, the first MP3 or WMA file is played. To make the file check finish more quickly, we recommend you do not write in any files other than MP3 or WMA files or create any unnecessary folders.

If the discs contain a mixture of music data and MP3 or WMA format data, only music data can be played.

- Extensions

If the file extensions .mp3 and .wma are used for files other than MP3 and WMA files, they will be mistakenly recognized and played as MP3 and WMA files. This may result in large amounts of interference and damage to the speakers.

- Playback

- To play MP3 file with steady sound quality, we recommend a fixed bit rate of 128 kbps and a sampling frequency of 44.1 kHz.
- CD-R or CD-RW playback may not be possible in some instances, depending on the characteristics of the disc.
- There is a wide variety of freeware and other encoding software for MP3 and WMA files on the market, and depending on the status of the encoding and the file format, poor sound quality or noise at the start of playback may result. In some cases, playback may not be possible at all.
- When files other than MP3 or WMA files are recorded on a disc, it may take more time to recognize the disc and in some cases, playback may not be possible at all.
- Microsoft, Windows, and Windows Media are the registered trademarks of Microsoft Corporation in the U.S. and other countries.

**NOTICE**

■ **CDs and adapters that cannot be used (→P. 330)**

■ **CD player precautions (→P. 331)**

3-2. Using the audio system Operating an iPod*

Connecting an iPod enables you to enjoy music from the vehicle speakers.

■ Connecting an iPod

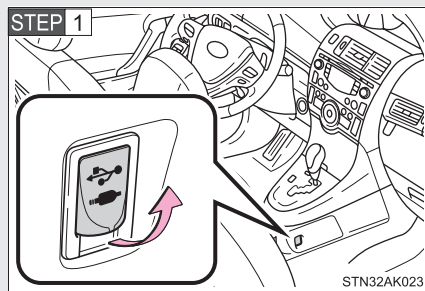

Open the cover and connect an iPod using an iPod cable.

Turn on the power of the iPod if it is not turned on.

STEP 2 Press .

■ Control panel

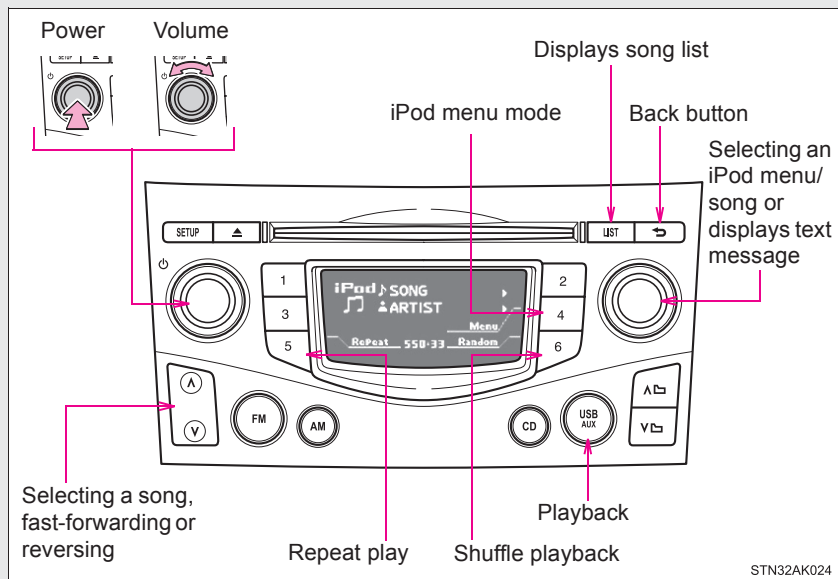

*: If equipped

Selecting a play mode

STEP 1 Press  (Menu) to select iPod menu mode.

STEP 2 Turning  clockwise changes the play mode in the following order:

“Playlists” → “Artists” → “Albums” → “Songs” → “Podcasts”
→ “Genres” → “Composers” → “Audiobooks”

STEP 3 Press  to select the desired play mode.

■ Play mode list

Play mode	First selection	Second selection	Third selection	Fourth selection
“Playlists”	Playlists select	Songs select	-	-
“Artists”	Artists select	Albums select	Songs select	-
“Albums”	Albums select	Songs select	-	-
“Songs”	Songs select	-	-	-
“Podcasts”	Podcasts select	Episodes select	-	-
“Genres”	Genre select	Artists select	Albums select	Songs select
“Composers”	Composers select	Albums select	Songs select	-
“Audiobooks”	Audiobooks select	Chapter select	-	-

3-2. Using the audio system

■ Selecting a list

STEP 1 Turn  to display the first selection list.



STEP 2 Press  to select the desired item.

Pressing the knob changes to the second selection list.

STEP 3 Repeat the same procedure to select the desired item.

To return to the previous selection list, press .

Selecting songs

Turn  or press “^” or “v” on  to select the desired song.

Selecting a song from the song list

STEP 1 Press .

The song list will be displayed.

STEP 2 Turn  to select a song.

STEP 3 Press  to play the song.

To return to the previous display, press .

Fast-forwarding and reversing songs

To fast-forward or reverse, press and hold “^” or “v” on .

Shuffle playback

Pressing  (Random) changes modes in the following order:

Track shuffle → Album shuffle → Off

Repeat play



Press  (Repeat).

To cancel, press  (Repeat) again.

Switching the display

Press .

Track title, Artist name and Album title are shown on the display.

To return to the previous display, press  or .

Adjusting sound quality and volume balance

STEP 1 Press  to enter iPod menu mode.

STEP 2 Pressing  changes sound modes. (→P. 352)

■ **About iPod**

- Apple is not responsible for the operation of this device or its compliance with safety and regulatory standards.
- iPod is a trademark of Apple Inc., registered in the U.S. and other countries.

■ **iPod functions**

- When an iPod is connected and the audio source is changed to iPod mode, the iPod will resume play from the same point in which it was last used.
- Depending on the iPod that is connected to the system, certain functions may not be available. If a function is unavailable due to a malfunction (as opposed to a system specification), disconnecting the device and reconnecting it once again may resolve the problem.
- While connected to the system, the iPod cannot be operated with its own controls. It is necessary to use the controls of the vehicle's audio system instead.

■ **iPod problems**

To resolve most problems encountered when using your iPod, disconnect your iPod from the vehicle iPod connection and reset it. For instructions on how to reset your iPod, refer to your iPod Owner's Manual.

■ **Display**

→P. 329

■ **Error messages**

- “ERROR”: This indicates a problem in the iPod or its connection.
- “NO SONGS”: This indicates that there is no music data in the iPod.
- “NO PLAYLIST”: This indicates that some available songs are not found in a selected playlist.
- “UPDATE YOUR IPOD”: This indicates that the version of the iPod is not compatible. Upgrade your iPod software to the latest version.

■ Compatible models

Model	Generation	Software version
iPod	5th generation	Ver. 1.3.0
iPod nano	1st generation	Ver. 1.3.1
	2nd generation	Ver. 1.1.3
	3rd generation	Ver. 1.1.3
	4th generation	Ver. 1.0.4
	5th generation	Ver. 1.0.2
	6th generation	Ver. 1.0.0
iPod touch	1st generation	Ver. 3.1.3
	2nd generation	Ver. 3.1.3
		Ver. 4.2.1
	Late 2009 (8 GB)	Ver. 3.1.3
		Ver. 4.2.1
	3rd generation (32 GB/64 GB)	Ver. 3.1.3
Ver. 4.2.1		
4th generation	Ver. 4.2.1	
iPod classic	1st generation	Ver. 1.1.2
	2nd generation (120 GB)	Ver. 2.0.1
	Late 2009 (160 GB)	Ver. 2.0.4
iPhone	1st generation (iPhone)	Ver. 3.1.3
	2nd generation (iPhone 3G)	Ver. 3.1.3
		Ver. 4.2.1
	3rd generation (iPhone 3GS)	Ver. 3.1.3
		Ver. 4.2.1
4th generation (iPhone 4)	Ver. 4.2.1	

3-2. Using the audio system

Depending on differences between models or software version etc., some models listed above might be incompatible with this system.

iPod 4th generation and earlier models are not compatible with this system.

iPod mini, iPod shuffle and iPod photo are not compatible with this system.

Items related to standards and limitations are as follows:

- Maximum number of lists in device: 9999
- Maximum number of songs in device: 65535
- Maximum number of songs per list: 65535

CAUTION

■ **Caution while driving**

Do not connect iPod or operate the controls. Doing so may cause an accident, resulting in death or serious injury.

NOTICE

■ **To prevent damage to iPod or its terminal**

- Do not leave iPod in the vehicle. The temperature inside the vehicle may become high, resulting in damage to the iPod.
- Do not push down on or apply unnecessary pressure to the iPod while it is connected as this may damage the iPod or its terminal.
- Do not insert foreign objects into the port as this may damage the iPod or its terminal.

3-2. Using the audio system Operating a USB memory*

Connecting a USB memory enables you to enjoy music from the vehicle speakers.

■ Connecting a USB memory

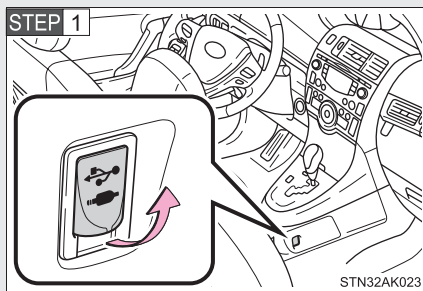

Open the cover and connect a USB memory.

Turn on the power of the USB memory if it is not turned on.

STEP 2 Press .

■ Control panel

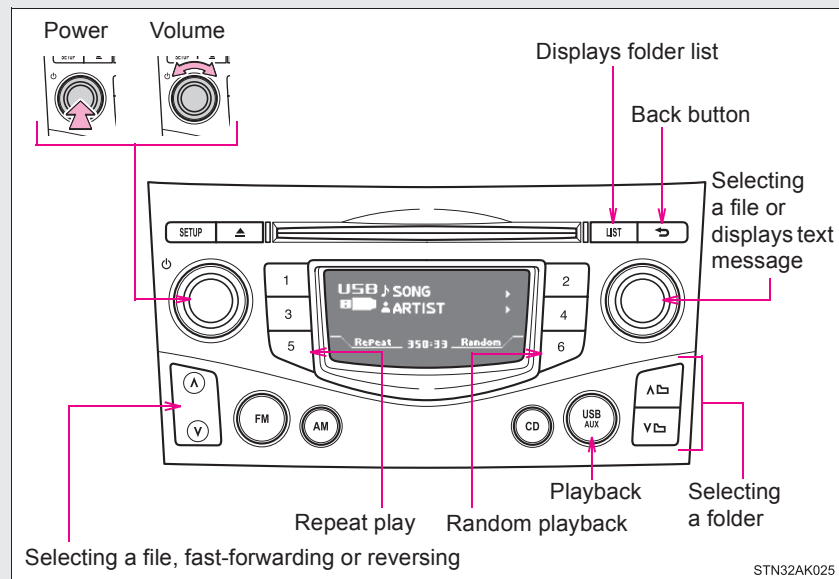

*: If equipped

Selecting a folder

■ Selecting folders one at a time

Press “^” or “v” on  to select the desired folder.

■ Selecting a folder and file from folder list

STEP 1 Press .

The folder list will be displayed.

STEP 2 Turn and press  to select a folder and a file.



To return to the previous display, press .

To exit, press .

■ Returning to the first folder

Press and hold “v” on  until you hear a beep.

Selecting files

Turn  or press “^” or “v” on  to select the desired file.

Fast-forwarding and reversing files

To fast-forward or reverse, press and hold “^” or “v” on .

Random playback

Pressing  (Random) changes modes in the following order:
Folder random → USB random → Off

Repeat play



Pressing  (Repeat) changes modes in the following order:
File repeat → Folder repeat* → Off

*: Available except when Random (random playback) is selected

Switching the display

Press .

Track title, Artist name and Album title (MP3 only) are shown on the display.

To return to the previous display, press  or .

■ USB memory functions

- Depending on the USB memory that is connected to the system, the device itself may not be operable and certain functions may not be available. If the device is inoperable or a function is unavailable due to a malfunction (as opposed to a system specification), disconnecting the device and reconnecting it once again may resolve the problem.
- If the USB memory still does not begin operation after being disconnected and reconnected, format the memory.

■ Display

→P. 329

■ Error messages

“ERROR”: This indicates a problem in the USB memory or its connection.

“NO MUSIC”: This indicates that no MP3/WMA files are included in the USB memory.

■ **USB memory**

● **Compatible devices**

USB memory that can be used for MP3 and WMA playback

● **Compatible device formats**

The following device formats can be used:

- USB communication formats: USB2.0 FS (12 mbps)
- File formats: FAT16/32 (Windows)
- Correspondence class: Mass storage class

MP3 and WMA files written in any format other than those listed above may not play correctly, and their file names and folder names may not be displayed correctly.

Items related to standards and limitations are as follows:

- Maximum directory hierarchy: 8 levels
- Maximum number of folders in a device: 999 (including the root)
- Maximum number of files in a device: 9999
- Maximum number of files per folder: 255

● **MP3 and WMA files**

MP3 (MPEG Audio LAYER 3) is a standard audio compression format.

Files can be compressed to approximately 1/10 of their original size using MP3 compression.

WMA (Windows Media Audio) is a Microsoft audio compression format.

This format compresses audio data to a size smaller than that of the MP3 format.

There is a limit to the MP3 and WMA file standards that can be used and to the media/formats on which the files are recorded.

- MP3 file compatibility
 - Compatible standards
MP3 (MPEG1 AUDIO LAYERII, III, MPEG2 AUDIO LAYERII, III, MPEG2.5)
 - Compatible sampling frequencies
MPEG1 AUDIO LAYERII, III: 32, 44.1, 48 (kHz)
MPEG2 AUDIO LAYERII, III: 16, 22.05, 24 (kHz)
MPEG2.5: 8, 11.025, 12 (kHz)
 - Compatible bit rates (compatible with VBR)
MPEG1 AUDIO LAYERII, III: 32-320 (kbps)
MPEG2 AUDIO LAYERII, III: 32-160 (kbps)
MPEG2.5: 32-160 (kbps)
 - Compatible channel modes: stereo, joint stereo, dual channel and monaural
- WMA file compatibility
 - Compatible standards
WMA Ver. 9
 - Compatible sampling frequencies
HIGH PROFILE 32, 44.1, 48 (kHz)
 - Compatible bit rates
HIGH PROFILE 32-320 (kbps, VBR)
- File names

The only files that can be recognized as MP3/WMA and played are those with the extension .mp3 or .wma.
- ID3 and WMA tags

ID3 tags can be added to MP3 files, making it possible to record the track title, artist name, etc.

The system is compatible with ID3 Ver. 1.0, 1.1, and Ver. 2.2, 2.3, 2.4 ID3 tags. (The number of characters is based on ID3 Ver. 1.0 and 1.1.)

WMA tags can be added to WMA files, making it possible to record the track title and artist name in the same way as with ID3 tags.

3-2. Using the audio system

● MP3 and WMA playback

- When a device containing MP3 or WMA files is connected, all files in the USB memory are checked. Once the file check is finished, the first MP3 or WMA file is played. To make the file check finish more quickly, we recommend that you do not include any files other than MP3 or WMA files or create any unnecessary folders.
- When the USB memory is connected and the audio source is changed to USB memory mode, the USB memory will start playing the first file in the first folder. If the same device is removed and reinserted (and the contents have not been changed), the USB memory will resume play from the same point in which it was last used.

● Extensions

If the file extensions .mp3 and .wma are used for files other than MP3 and WMA files, they will be skipped (not played).

● Playback

- To play MP3 files with steady sound quality, we recommend a fixed bit rate of at least 128 kbps and a sampling frequency of 44.1 kHz.
- There is a wide variety of freeware and other encoding software for MP3 and WMA files on the market, and depending on the status of the encoding and the file format, poor sound quality or noise at the start of playback may result. In some cases, playback may not be possible at all.
- Microsoft, Windows, and Windows Media are registered trademarks of Microsoft Corporation in the U.S.A. and other countries.

CAUTION

■ Caution while driving

Do not connect USB memory or operate the controls. Doing so may cause an accident, resulting in death or serious injury.

 NOTICE

■ **To prevent damage to USB memory or its terminal**

- Do not leave USB memory in the vehicle. The temperature inside the vehicle may become high, resulting in damage to the USB memory.
- Do not push down on or apply unnecessary pressure to the USB memory while it is connected as this may damage the USB memory or its terminal.
- Do not insert foreign objects into the port as this may damage the USB memory or its terminal.
- Depending on the size and shape of the USB memory that is connected to the system, the passenger's seat may hit the USB memory when moving the seat forward. In this case, do not forcibly move the seat forward as this may damage the USB memory or the terminal, etc.

3-2. Using the audio system

Optimal use of the audio system*

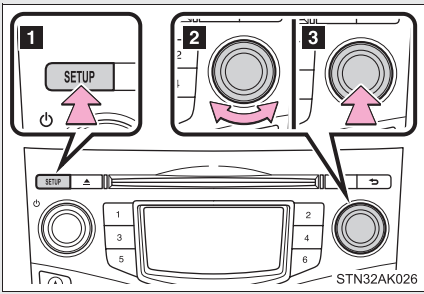

1 Displays the current mode

2 Changes the following settings

- Sound quality and volume balance (→P. 353)

The sound quality and balance setting can be changed to produce the best sound.

- Automatic Sound Levelizer on/off (→P. 353)

3 Selecting the mode

Using the audio control function

■ Changing sound quality modes

STEP 1 Press  .

STEP 2 Turn  to select “Sound Setting”.

STEP 3 Press  .

STEP 4 Turn  as corresponds to the desired mode.

“BASS”, “TREBLE”, “FADER”, “BALANCE”, or “ASL”

STEP 5 Press  .

*: If equipped

■ Adjusting sound quality

Turning  adjusts the level.

Sound quality mode	Mode displayed	Level	Turn to the left	Turn to the right
Bass*	"BASS"	-5 to 5	Low	High
Treble*	"TREBLE"	-5 to 5		
Front/rear volume balance	"FADER"	R7 to F7	Shifts to rear	Shifts to front
Left/right volume balance	"BALANCE"	L7 to R7	Shifts to left	Shifts to right

*: The sound quality level is adjusted individually in each audio mode.

■ Adjusting the Automatic Sound Levelizer (ASL)

When ASL is selected, turning  to the right changes the amount of ASL in the order of LOW, MID and HIGH.

Turning  to the left turns ASL off.

ASL automatically adjusts the volume and tone quality according to vehicle speed.

3-2. Using the audio system

Using the AUX port*

This port can be used to connect a portable audio device and listen to it through the vehicle's speakers.

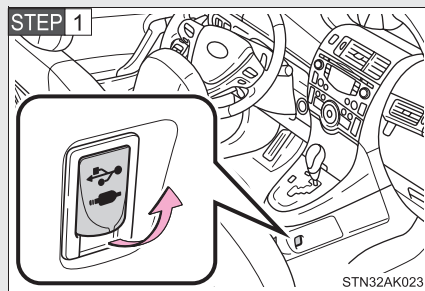

Open the cover and connect the portable audio device.

STEP 2 Press  until "AUX" is displayed.

■ Operating portable audio devices connected to the audio system

The volume can be adjusted using the vehicle's audio controls. All other adjustments must be made on the portable audio device itself.

■ When using a portable audio device connected to the power outlet

Noise may occur during playback. Use the power source of the portable audio device.

*: If equipped

3-2. Using the audio system

Using the steering wheel audio switches

Some audio features can be controlled using the switches on the steering wheel.

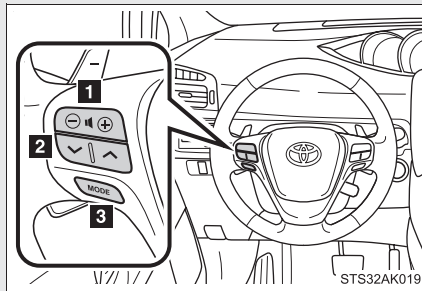



- 1** Volume
- 2** Radio mode: Select radio stations
CD mode: Select tracks and files (MP3 and WMA)
iPod mode: Selects a song
USB memory mode: Selects a file and folder
- 3** Power on, select audio source

Turning on the power

Press  when the audio system is turned off.

Changing the audio source

Press  when the audio system is turned on. The audio source changes as follows each time  is pressed. If a mode cannot be used, it will be skipped.

AM→FM→CD mode→iPod or USB memory*→AUX*

*: If equipped

3-2. Using the audio system

Adjusting the volume

Press “+” on  to increase the volume and “-” to decrease the volume.

Hold down “+” or “-” on  to continue increasing or decreasing the volume.

Silencing a sound

Press and hold .

To cancel, press and hold  again.

Selecting a radio station

STEP 1 Press  to select the radio mode.

STEP 2 Press “^” or “v” on  to select a preset station.

To scan for receivable stations, press and hold “^” or “v” on  until you hear a beep.

Selecting a track/file or song

STEP 1 Press  to select the CD, iPod or USB memory mode.

STEP 2 Press “^” or “v” on  to select the desired track/file or song.

Selecting a folder (MP3 and WMA or USB memory)

STEP 1 Press  to select the CD or USB memory mode.

STEP 2 Press and hold “^” or “v” on  until you hear a beep.

 CAUTION

■ **To reduce the risk of an accident**

Exercise care when operating the audio switches on the steering wheel.

3-3. Using the interior lights

Interior lights list

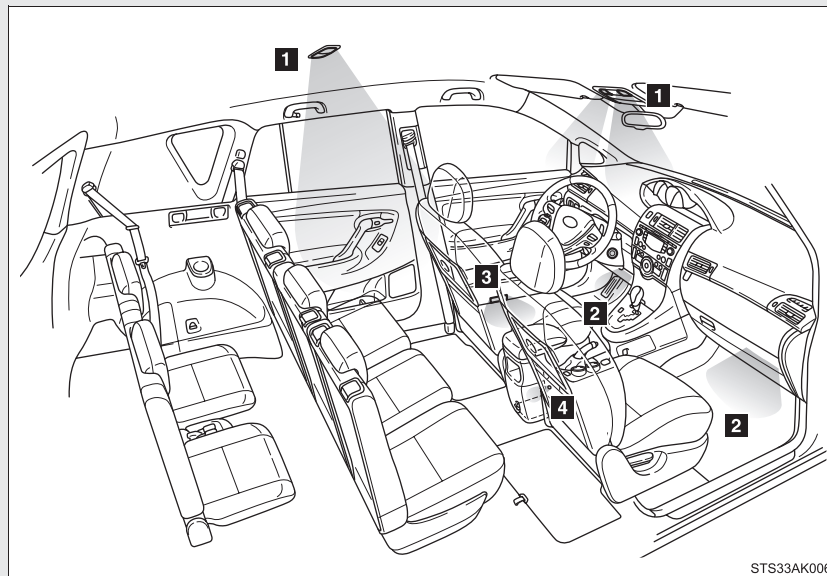

- 1** Personal/interior lights (→P. 359, 360)
- 2** Foot lights
- 3** Front door courtesy lights (if equipped)
- 4** Console box light (if equipped)

Personal/interior lights main switch

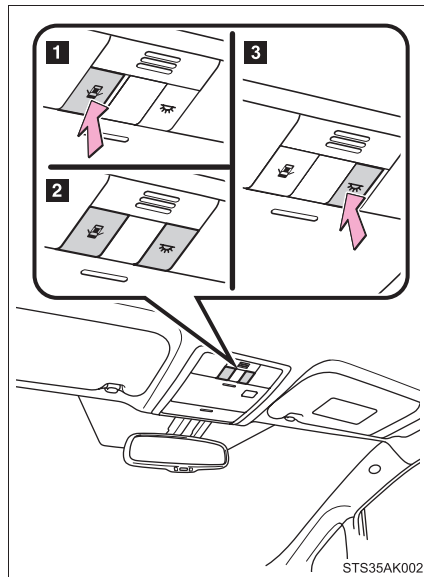

1 Off

The personal/interior lights can be individually turned on or off.

2 Door position

When neither of the main switches (**1** or **3**) is pressed:

The personal/interior lights come on when a door is opened. They turn off when the doors are closed. The personal/interior lights can be individually turned on when the doors are closed.

3 On

The personal/interior lights cannot be individually turned off.

Personal/interior lights

► Front

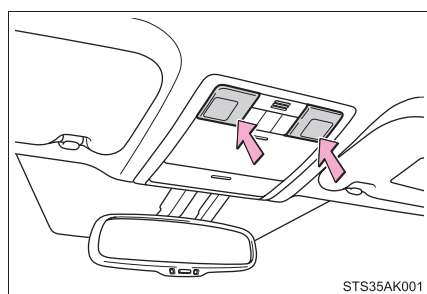

On/off

► Rear

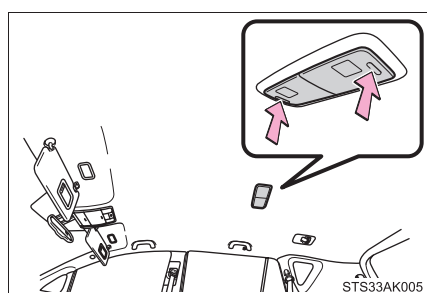

On/off

■ Illuminated entry system**▶ Vehicles without smart entry & start system**

The lights automatically turn on/off according to the engine switch position, whether the doors are locked/unlocked, and whether the doors are open/closed.

▶ Vehicles with smart entry & start system

The lights automatically turn on/off according to “ENGINE START STOP” switch mode, the presence of the electronic key, whether the doors are locked/unlocked, and whether the doors are open/closed.

■ To prevent battery discharge**▶ Vehicles without smart entry & start system**

If the interior lights remain on when the engine switch is turned off, the lights will go off automatically after 20 minutes.

▶ Vehicles with smart entry & start system

If the interior lights remain on when the “ENGINE START STOP” switch is turned off, the lights will go off automatically after 20 minutes.

■ Customization that can be configured at any authorized Toyota dealer or repairer, or another duly qualified and equipped professional

Settings (e.g. The time elapsed before lights turn off) can be changed.
(Customizable features →P. 602)

3-4. Using the storage features

List of storage features

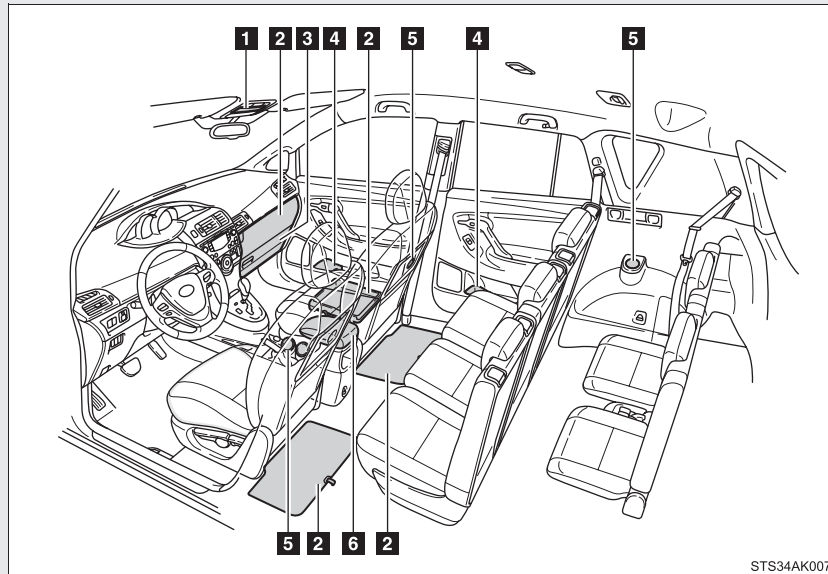

- 1 Overhead console
- 2 Auxiliary boxes
- 3 Glove box
- 4 Bottle holders
- 5 Cup holders
- 6 Console box

⚠ CAUTION

■ Items that should not be left in the storage spaces

Do not leave glasses, lighters or spray cans in the storage spaces, as this may result in the following when cabin temperature becomes high:

- Glasses may be deformed by heat or cracked if they come into contact with other stored items.
- Lighters or spray cans may explode. If they come into contact with other stored items, the lighter may catch fire or the spray can may release gas, causing a fire hazard.

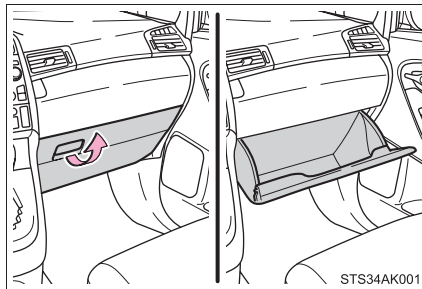
Glove box▶ **Glove box without lock function**

Pull up the lever to open the glove box.

▶ **Glove box with lock function**

Pull up the lever to open the glove box.

The glove box can be locked and unlocked by using the key (vehicles without smart entry & start system) or the mechanical key (vehicles with smart entry & start system).

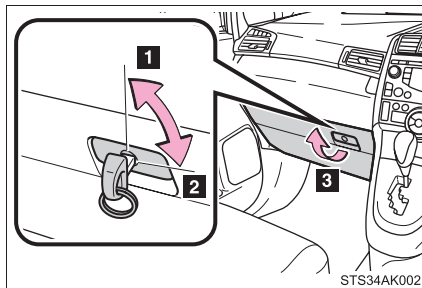

1 Unlock

2 Lock

3 Open

■ **Glove box light**

The glove box light turns on when the tail lights are on.

⚠ CAUTION

■ Caution while driving

Keep the glove box closed. In the event of sudden braking or sudden swerving, an accident may occur due to an occupant being struck by the open glove box or the items stored inside.

Console box

▶ Type A

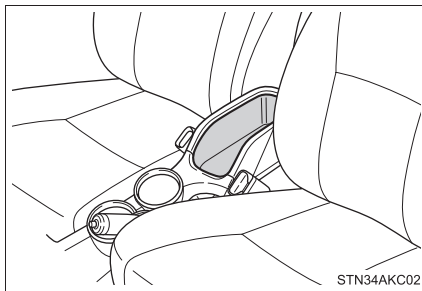

▶ Type B

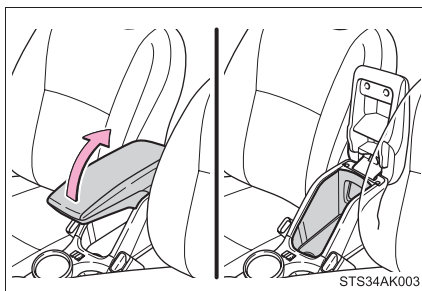

Lift the lid to open.

■ Tray in the console box

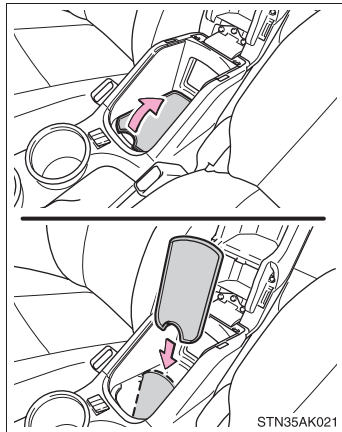

The tray can be removed and used as a separator.

⚠ CAUTION

■ **Caution while driving (type B)**

Keep the console box closed. In the event of sudden braking or sudden swerving, an accident may occur due to an occupant being struck by the open console box or the items stored inside.

Overhead console

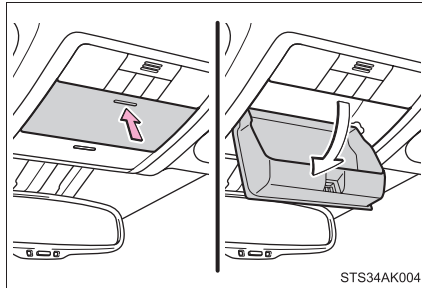

Press the lid to open.

The overhead console is useful for temporarily storing small items.

⚠ CAUTION

■ Caution while driving

Do not leave the overhead console open. Items stored in it may fall out and cause injury.

Cup holders

► Type A

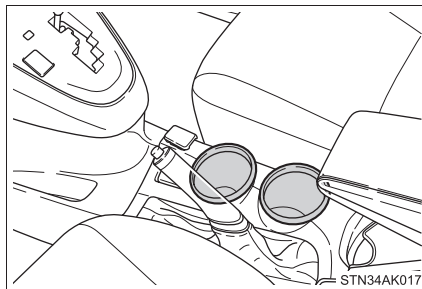

► Type B (if equipped)

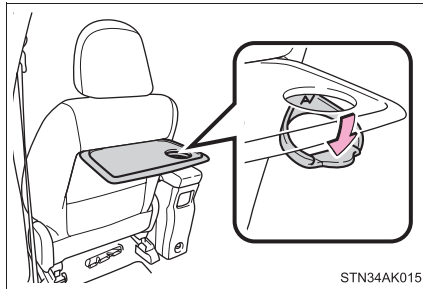

► Type C

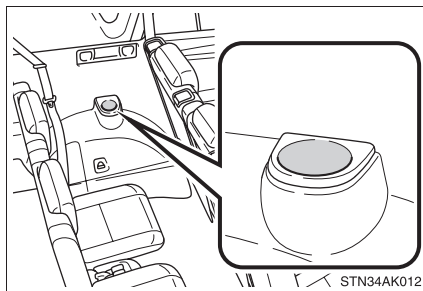

⚠ CAUTION

■ **Items unsuitable for the cup holder**

Do not place anything other than cups or beverage cans in the cup holders. Other items may be thrown out of the holders in the event of an accident or sudden braking, causing injury. If possible, cover hot drinks to prevent burns.

Bottle holders

► Front

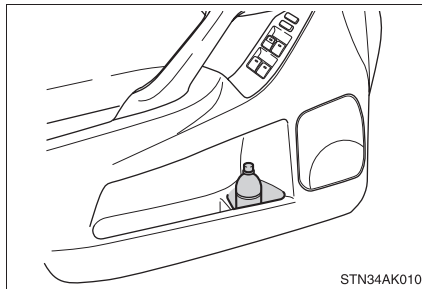

► Rear

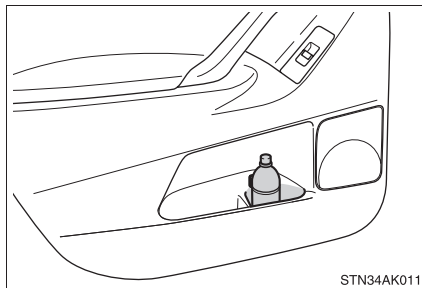
**⚠ CAUTION****■ Items unsuitable for the bottle holder**

Do not place anything other than a bottle in the bottle holders. Other items may be thrown out of the holders in the event of an accident or sudden braking, causing injury.

⚠ NOTICE**■ Items that should not be stowed in the bottle holders**

Put the cap on before stowing a bottle. Do not place open bottles in the bottle holders, or glasses and paper cups containing liquid. The contents may spill and glasses may break.

Auxiliary boxes

▶ Type A

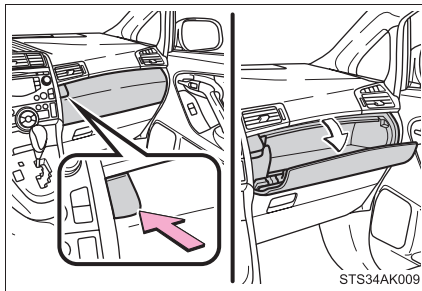

Press the button to open the lid.

▶ Type B for passenger side (if equipped)

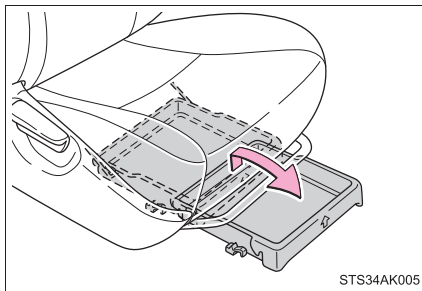

Lift the tray and pull it forward.

▶ Type C

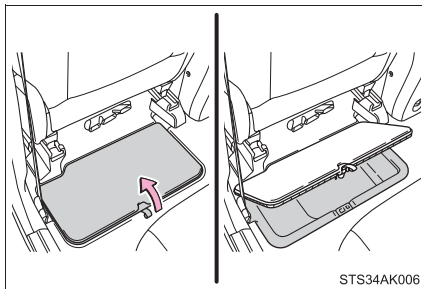

Pull the strap to open the lid.

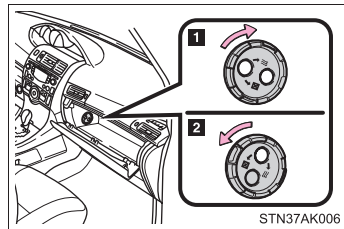
■ Using the auxiliary box vent (if equipped)

Air from the air conditioner can be distributed into the auxiliary box by opening and closing the vent.

1 Open

2 Close

The air is conditioned the same as the air for the passenger side vent.

Perishable items should not be put in the box.

⚠ CAUTION**■ Caution while driving**

Keep the auxiliary boxes closed. In the event of sudden braking or sudden swerving, an accident may occur due to an occupant being struck by an open auxiliary box or the items stored inside.

3-5. Other interior features

Sun visors

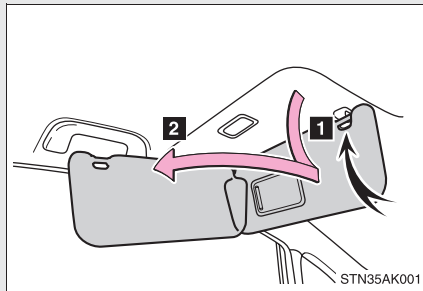

- 1** To set the visor in the forward position, flip it down.
- 2** To set the visor in the side position, flip down, unhook, and swing it to the side.

3-5. Other interior features

Vanity mirrors

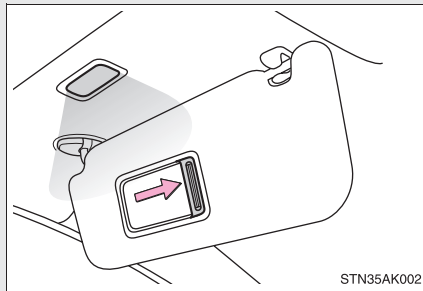

Slide the cover.

The light turns on when the cover is opened.

 **NOTICE**

■ To prevent battery discharge

Do not leave the vanity lights on for extended periods while the engine is off.

3-5. Other interior features

Conversation mirror

The conversation mirror can be used when a driver needs to confirm the rear seat condition.

Press the lid to open.

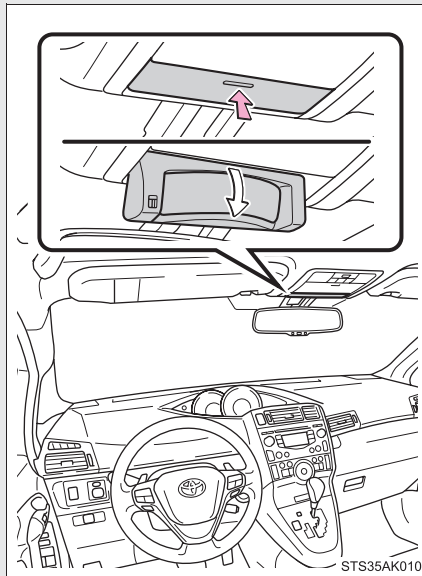

3-5. Other interior features

Power outlets

Please use as a power supply for electronic goods that use less than 12 VDC/10 A (power consumption of 120 W).

When using electronic goods, make sure that the power consumption of all the connected power outlets is less than 120 W.

► Center console

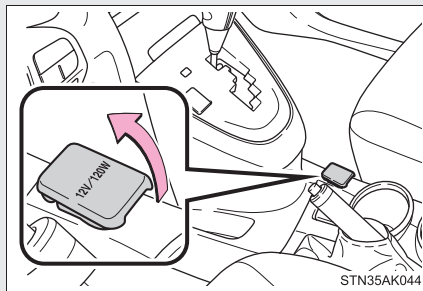

► Console box (if equipped)

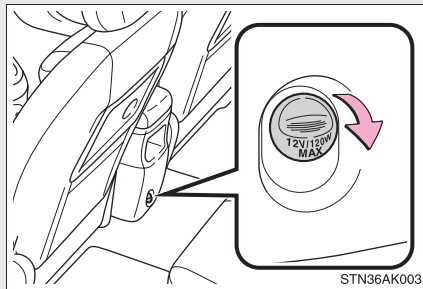

► Luggage compartment

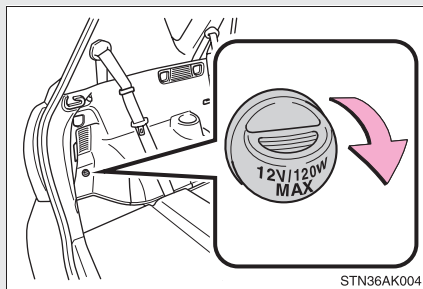

■ **The power outlet can be used when**

- ▶ Vehicles without smart entry & start system

The engine switch is in the “ACC” or “ON” position.

- ▶ Vehicles with smart entry & start system

The “ENGINE START STOP” switch is in ACCESSORY or IGNITION ON mode.

 **NOTICE**

■ **To avoid damaging the power outlet**

Close the power outlet lid when the power outlet is not in use.

Foreign objects or liquids that enter the power outlet may cause a short circuit.

■ **To prevent battery discharge**

Do not use the power outlet longer than necessary when the engine is not running.

3-5. Other interior features

Seat heaters*

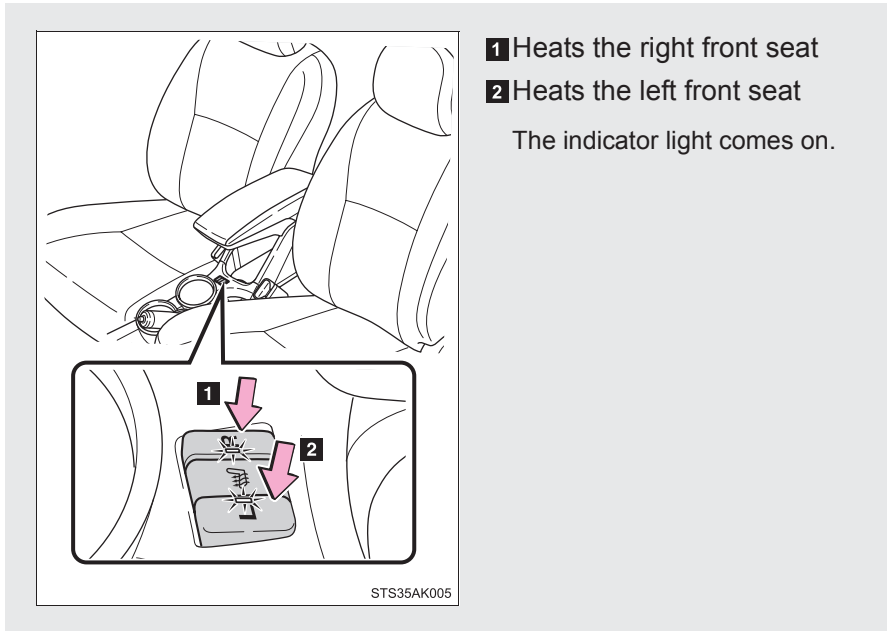

■ The seat heaters can be used when

- ▶ Vehicles without smart entry & start system

The engine switch is in the "ON" position.

- ▶ Vehicles with smart entry & start system

The "ENGINE START STOP" switch is in IGNITION ON mode.

■ When not in use

Turn the seat heater off.

*: If equipped

 CAUTION

■ **Burns**

- Use caution when seating the following persons in a seat with the seat heater on to avoid the possibility of burns:
 - Babies, small children, the elderly, the sick and the physically challenged
 - Persons with sensitive skin
 - Persons who are fatigued
 - Persons who have taken alcohol or drugs that induce sleep (sleeping drugs, cold remedies, etc.)
- Do not cover the seat with anything when using the seat heater. Using the seat heater with a blanket or cushion increases the temperature of the seat and may lead to overheating.
- Do not use the seat heater more than necessary. Doing so may cause minor burns or overheating.

 NOTICE

■ **To prevent seat heater damage**

Do not put heavy objects that have an uneven surface on the seat and do not stick sharp objects (needles, nails, etc.) into the seat.

■ **To prevent battery discharge**

Turn the seat heaters off when the engine is not running.

3-5. Other interior features

Armrests*

► Front

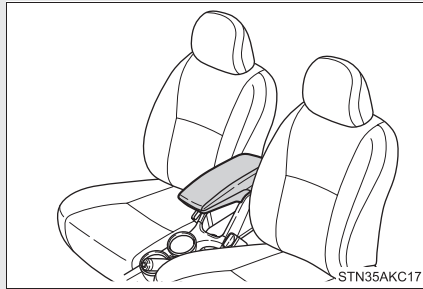

► Rear

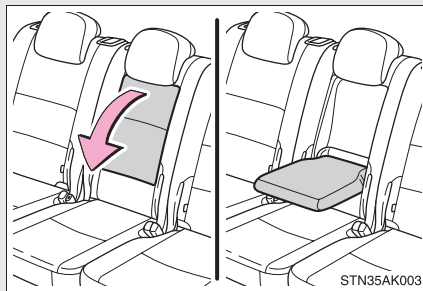

Pull the armrest down for use.

⚠ NOTICE

- **To prevent damage to the armrest**
Do not apply too much load on the armrest.

*: If equipped

3-5. Other interior features

Front seatback tables*

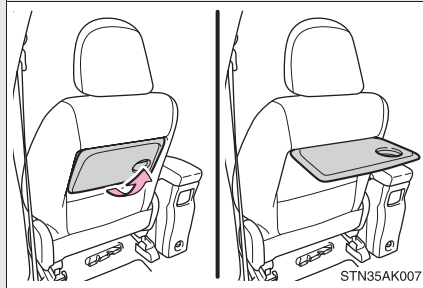

Pull up the front seatback table.

■ Stowing the front seatback table

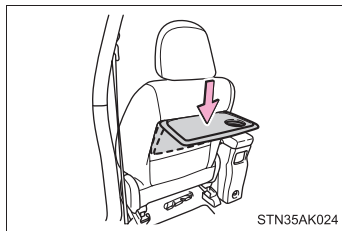

Push down the front seatback table.

3

Interior features

*: If equipped

379

 CAUTION

■ **Front seatback table precautions**

Failure to follow the precautions below may cause death or serious injury.

- Be careful not to get your hands caught in the front seatback table.
- Do not use the front seatback table while the vehicle is moving.
- Make sure the front seatback table is folded down and locked securely when not in use.
- Do not use the front seatback table while using a child restraint system on the second seat.
- Do not move the front seats.
- Do not lean on the front seatback table or put your hands or elbow on it.

 NOTICE

■ **To prevent damage to the front seatback table**

Do not place more than 2 kg (4.4 lb.) of weight on the front seatback table. The table could retract unexpectedly, possibly damaging the front seatback table.

3-5. Other interior features

Rear side sunshades*

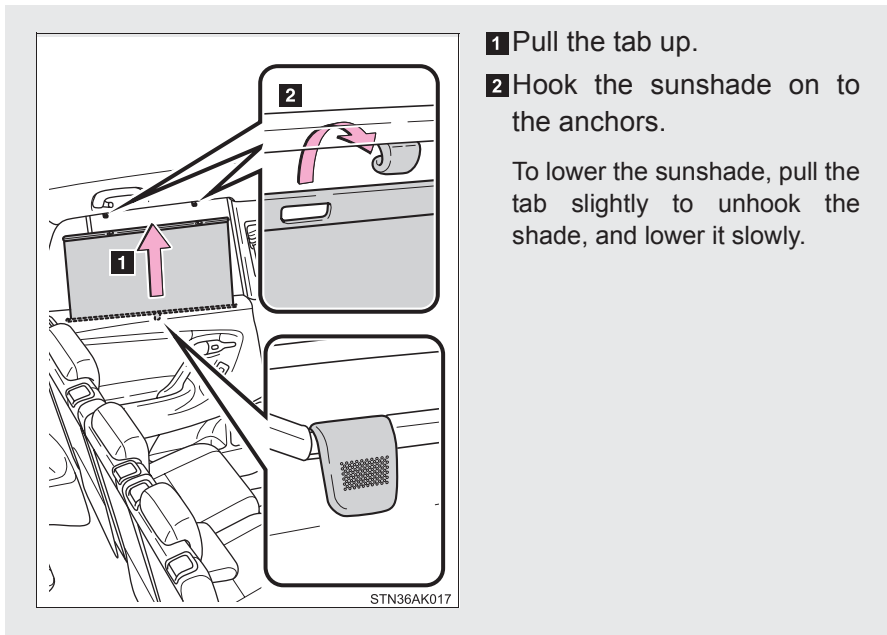

1 Pull the tab up.

2 Hook the sunshade on to the anchors.

To lower the sunshade, pull the tab slightly to unhook the shade, and lower it slowly.

⚠ CAUTION

■ When the rear side sunshade is being raised or lowered

Do not place fingers or other objects in the fastener section or in the opening. They may get caught, causing injury.

⚠ NOTICE

■ To ensure normal operation of the sunshade

Observe the following precautions.

- Do not place anything where it may hinder the opening/closing of the sunshade.
- Do not place anything on the sunshade.

*: If equipped

3

Interior features

3-5. Other interior features

Assist grips

An assist grip installed on the ceiling can be used to support your body while sitting on the seat.

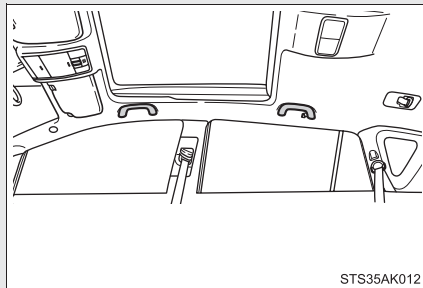

CAUTION

■ Assist grip

Do not use the assist grip when getting in or out of the vehicle or rising from your seat.

NOTICE

■ To prevent damage to the assist grip

Do not hang any heavy object or put a heavy load on the assist grip.

3-5. Other interior features

Floor mat

Use only floor mats designed specifically for vehicles of the same model and model year as your vehicle. Fix them securely in place onto the carpet.

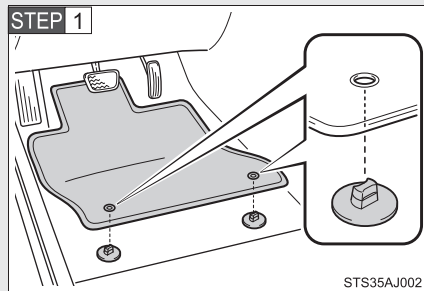

Insert the retaining hooks (clips) into the floor mat eyelets.

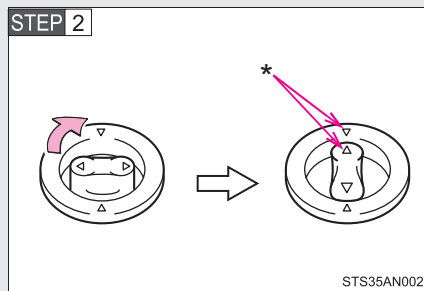

Turn the upper knob of each retaining hook (clip) to secure the floor mats in place.

*: Always align the \triangle marks.

The shape of the retaining hooks (clips) may differ from that shown in the illustration.

⚠ CAUTION

Observe the following precautions.

Failure to do so may cause the driver's floor mat to slip, possibly interfering with the pedals while driving. An unexpectedly high speed may result or it may become difficult to stop the vehicle. This could lead to an accident, resulting in death or serious injury.

■ **When installing the driver's floor mat**

- Do not use floor mats designed for other models or different model year vehicles, even if they are Toyota Genuine floor mats.
- Only use floor mats designed for the driver's seat.
- Always install the floor mat securely using the retaining hooks (clips) provided.
- Do not use two or more floor mats on top of each other.
- Do not place the floor mat bottom-side up or upside-down.

■ **Before driving**

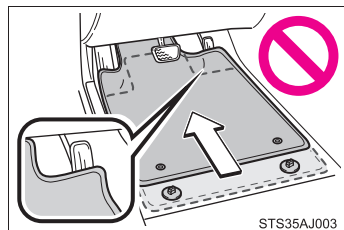

- Check that the floor mat is securely fixed in the correct place with all the provided retaining hooks (clips). Be especially careful to perform this check after cleaning the floor.
- With the engine stopped and the shift lever in "P" (Multidrive) or "N" (manual transmission), fully depress each pedal to the floor to make sure it does not interfere with the floor mat.

3-5. Other interior features

Luggage compartment features

■ Cargo hooks

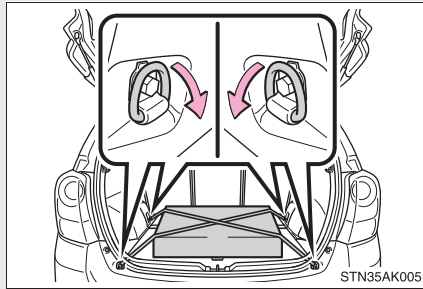

Cargo hooks are provided for securing loose items.

■ Dual-level deck board (if equipped)

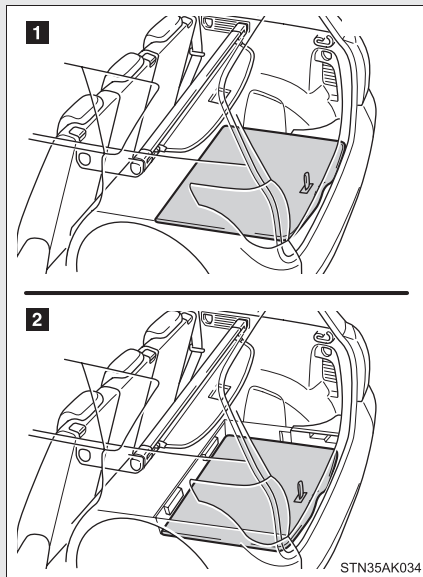

The position of the dual-level deck board can be changed (lowered/raised). (→P. 388)

- 1 Normal position
- 2 Low position

■ Auxiliary boxes (if equipped)

► Type A

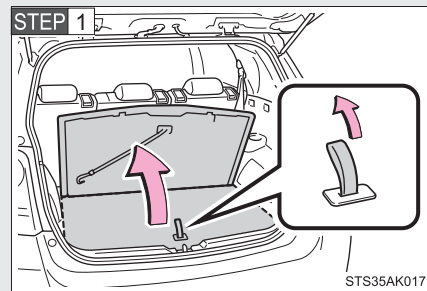

Open the rear deck board.

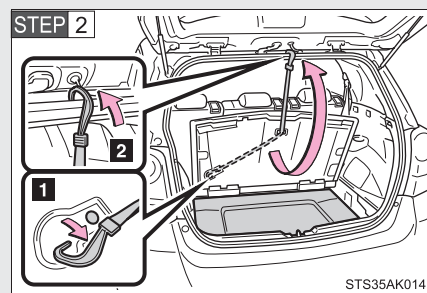

Secure the rear deck board, using the strap hook provided.

- 1 Remove the strap hook
- 2 Secure the hook

► Type B

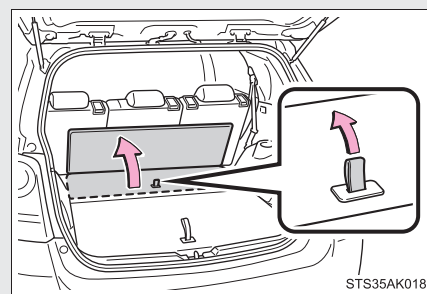

Open the front deck board.

► Type C

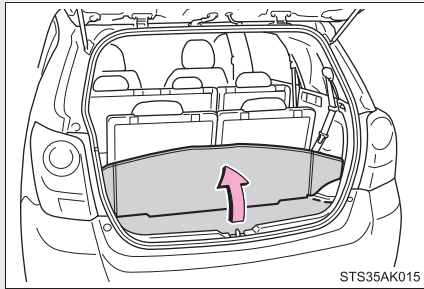

Open the rear deck board.

► Type D

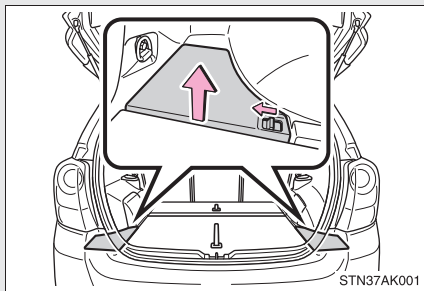

Pull the side deck boards while pushing the knob.

■ Luggage cover (if equipped)

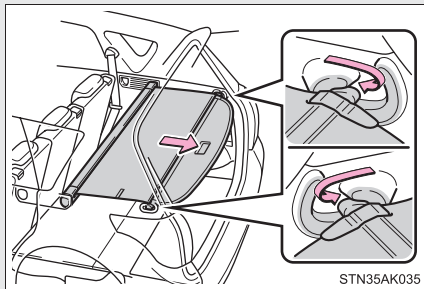

Pull out the luggage cover and hook it on the anchors.

If necessary, move the second seats back.

Lowering the dual-level deck board

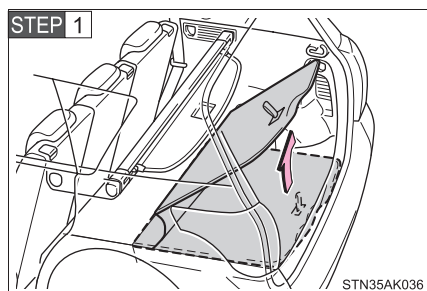

Lift the rear deck board and pull it back slightly.

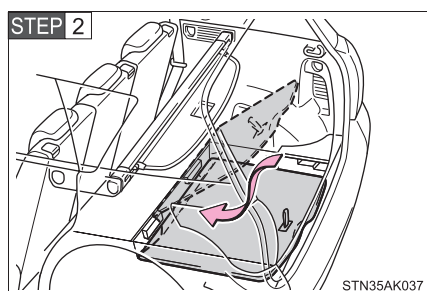

Install the deck board to the lower position by sliding the front edge down and forward, as shown in the illustration.

Removing luggage cover

The luggage cover can be removed by following the procedure below.

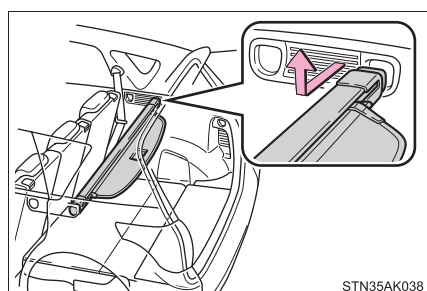

Push in the left side of the luggage cover while keeping hold of the right side. Then raise the right side and pull the luggage cover out.

Changing the position of the luggage cover

► Pattern A

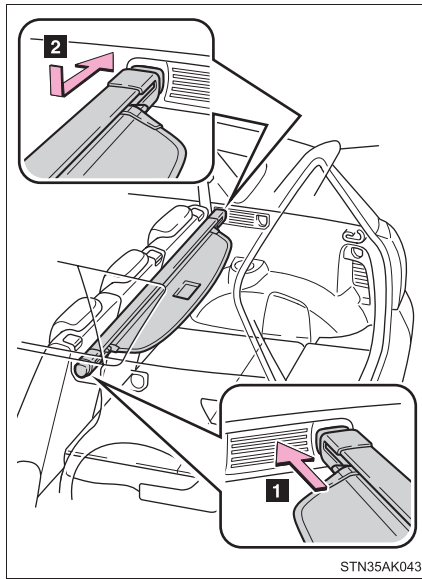

- 1** Insert the left end of the luggage cover into the hole.
- 2** Compress the right end of the luggage cover and insert it into the hole.

► Pattern B

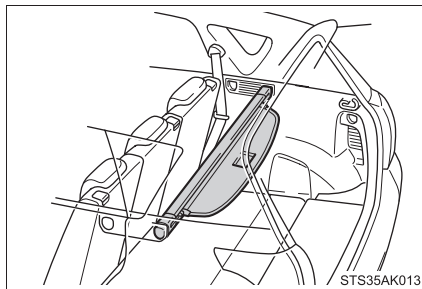

3-5. Other interior features

► Pattern C

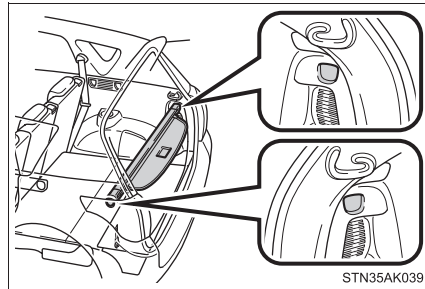

Stowing the luggage cover

► Type A

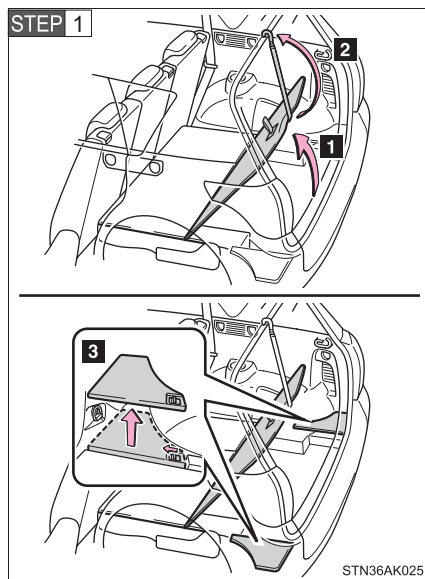

1 Lift the rear deck board.

2 Secure the rear deck board using the hook.

3 Remove the side deck boards.

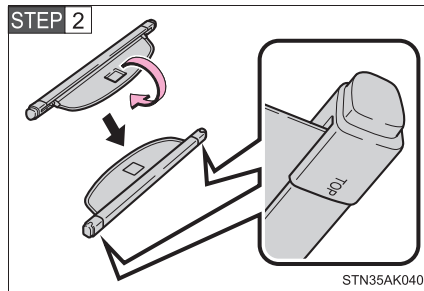

Turn the luggage cover upside down so that the "TOP" mark on the end faces down.

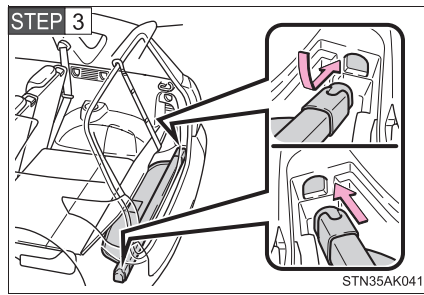

Place the left end of the luggage cover in the hole on the left side and then lower the right end into the hole on the right side.

STEP 4 Pull the deck board down to close.

3

Interior features

► Type B

STEP 1 Folding down the third seats. (→P. 90)

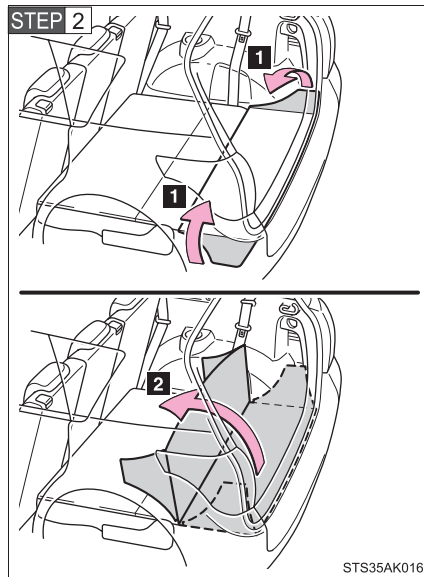

1 Fold in the outer sections of the deck board.

2 Open the deck board.

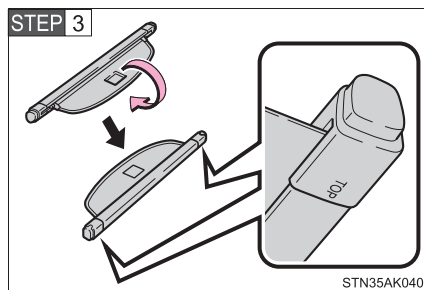

Turn the luggage cover upside down so that the “TOP” mark on the end faces down.

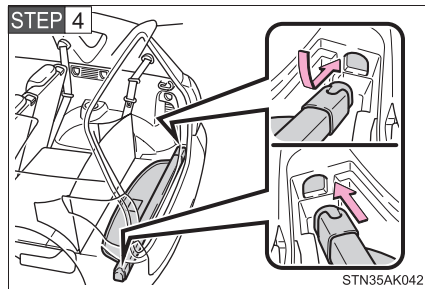

Place the left end of the luggage cover in the hole on the left side and then lower the right end into the hole on the right side.

STEP 5 Pull the deck board down to close.

⚠ CAUTION

■ **When the cargo hooks are not in use**

To avoid injury, always return the cargo hooks to their stowed positions.

■ **Caution while driving**

Keep the auxiliary box closed. In the event of sudden braking or sudden swerving, an accident may occur due to an occupant being struck by an open auxiliary box or the items stored inside.

■ **Caution for the luggage cover**

Do not allow children to climb on the luggage cover. Climbing on the luggage cover could result in damage to the luggage cover, possibly causing death or serious injury to the child.

3-5. Other interior features

- 4-1. Maintenance and care**
 - Cleaning and protecting the vehicle exterior 396
 - Cleaning and protecting the vehicle interior 400

- 4-2. Maintenance**
 - Maintenance requirements..... 403

- 4-3. Do-it-yourself maintenance**
 - Do-it-yourself service precautions 406
 - Hood 410
 - Positioning a floor jack..... 412
 - Engine compartment..... 414
 - Tires..... 431
 - Tire inflation pressure 445
 - Wheels..... 447
 - Air conditioning filter 450
 - Key battery..... 453
 - Checking and replacing fuses 457
 - Light bulbs 472

4-1. Maintenance and care

Cleaning and protecting the vehicle exterior

Perform the following to protect the vehicle and maintain it in prime condition.

- Working from top to bottom, liberally apply water to the vehicle body, wheel wells and underside of the vehicle to remove any dirt and dust.
- Wash the vehicle body using a sponge or soft cloth, such as a chamois.
- For hard-to-remove marks, use car wash soap and rinse thoroughly with water.
- Wipe away any water.
- Wax the vehicle when the waterproof coating deteriorates.

If water does not bead on a clean surface, apply wax when the vehicle body is cool.

■ Automatic car washes

- Fold the mirrors and remove the antenna before washing the vehicle. Start washing from the front of the vehicle. Make sure to re-install the antenna and extend the mirrors before driving.
- Brushes used in automatic car washes may scratch the vehicle surface and harm your vehicle's paint.
- Vehicles with rain-sensing windshield wipers: Turn the wipers off before washing the vehicle. (→P. 397)

■ High pressure car washes

- Do not allow the nozzles of the car wash to come within close proximity of the windows.
- Before using car wash, check that the fuel filler door on your vehicle is closed properly.

■ Aluminum wheels (if equipped)

- Remove any dirt immediately by using a neutral detergent. Do not use hard brushes or abrasive cleaners. Do not use strong or harsh chemical cleaners. Use the same mild detergent and wax as used on the paint.
- Do not use detergent on the wheels when they are hot, for example after driving for long distance in the hot weather.
- Wash detergent from the wheels immediately after use.

■ Bumpers

Do not scrub with abrasive cleaners.

⚠ CAUTION

■ **When cleaning the windshield (vehicles with rain-sensing windshield wipers)**

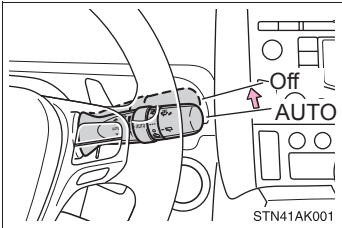

Set the wiper switch to off.
If the wiper switch is in "AUTO", the wipers may operate unexpectedly in the following situations, and may result in hands being caught or other serious injuries and cause damage to the wiper blades.

- When the upper part of the windshield where the raindrop sensor is located is touched by hand
- When a wet rag or similar is held close to the raindrop sensor
- If something bumps against the windshield
- If you directly touch the raindrop sensor body or if something bumps into the raindrop sensor

■ **Caution about the exhaust pipe**

Exhaust gasses cause the exhaust pipe to become quite hot.
When washing the vehicle, be careful not to touch the pipe until it has cooled sufficiently, as touching a hot exhaust pipe can cause burns.

 NOTICE

■ **To prevent paint deterioration and corrosion on the body and components (aluminum wheels etc.)**

- Wash the vehicle immediately in the following cases:
 - After driving near the sea coast
 - After driving on salted roads
 - If coal tar or tree sap is present on the paint surface
 - If dead insects, insect droppings or bird droppings are present on the paint surface
 - After driving in an area contaminated with soot, oily smoke, mine dust, iron powder or chemical substances
 - If the vehicle becomes heavily soiled in dust or mud
 - If liquids such as benzene and gasoline are spilled on the paint surface
- If the paint is chipped or scratched, have it repaired immediately.
- To prevent the wheels from corroding, remove any dirt and store in a place with low humidity when storing the wheels.

■ **Cleaning the exterior lights**

- Wash carefully. Do not use organic substances or scrub with a hard brush. This may damage the surfaces of the lights.
- Do not apply wax on the surfaces of the lights. Wax may cause damage to the lenses.

■ **Antenna installation and removal precautions**

- Before driving, ensure that the antenna is installed.
- When the antenna is removed, such as before entering an automatic car wash, make sure to store it in a suitable place so as not to lose it. Also, before driving, make sure to reinstall the antenna in its original position.

■ **To prevent damage to the windshield wiper arms**

When lifting the wiper arms away from the windshield pull the driver side wiper arm upward first, and repeat for the passenger side. When returning the wipers to their original position, do so from the passenger side first.

 NOTICE**■ When using an automatic car wash (vehicles with rain-sensing windshield wipers)**

Set the wiper switch to off. If the wiper switch is in “AUTO”, the wipers may operate and the wiper blades may be damaged.

■ When using a high pressure car wash

Do not bring the nozzle tip close to following parts and boots (Rubber or resin manufactured cover), or connectors. Parts may be damaged if they come into contact with high pressure water.

- Traction related parts
- Steering parts
- Suspension parts
- Brake parts

■ Handling of the camera (vehicles with rear view monitor system)

- As the camera has a water proof construction, do not detach, disassemble or modify it. This may cause incorrect operation.
- If the camera lens becomes dirty, it cannot transmit a clear image. If water droplets, snow, or mud adhere to the lens, rinse with water and wipe with a soft cloth. If the lens is extremely dirty, wash it with a mild cleanser and rinse.
- Do not allow organic solvent, car wax, window cleaner or glass coat to adhere to the camera. If this happens, wipe it off as soon as possible.
- When washing the vehicle, do not apply intensive bursts of water to the camera or camera area. Doing so may result in the camera malfunctioning.

4-1. Maintenance and care

Cleaning and protecting the vehicle interior

The following procedures will help protect your vehicle's interior and keep it in top condition:

■ Protecting the vehicle interior

Remove dirt and dust using a vacuum cleaner. Wipe dirty surfaces with a cloth dampened with lukewarm water.

■ Cleaning the leather areas

- Remove dirt and dust using a vacuum cleaner.
- Wipe any excess dirt and dust with a soft cloth dampened with diluted detergent.

Use a diluted water solution of approximately 5% neutral wool detergent.

- Wring out any excess water from the cloth and thoroughly wipe off all remaining traces of detergent.
- Wipe the surface with a dry, soft cloth to remove any remaining moisture. Allow the leather to dry in a shaded ventilated area.

■ Synthetic leather areas

- Remove loose dirt using a vacuum cleaner.
- Apply a mild soap solution to the synthetic leather using a sponge or soft cloth.
- Allow the solution to soak in for a few minutes. Remove the dirt and wipe off the solution with a clean, damp cloth.

■ Caring for leather areas

Toyota recommends cleaning the interior of the vehicle at least twice a year to maintain the quality of the vehicle's interior.

■ Shampooing the carpets

There are several commercial foaming-type cleaners available. Use a sponge or brush to apply the foam. Rub in overlapping circles. Do not apply water. Excellent results are obtained by keeping the carpet as dry as possible.

■ Seat belts

Clean with mild soap and lukewarm water using a cloth or sponge. Also check the belts periodically for excessive wear, fraying or cuts.

CAUTION

■ Water in the vehicle

- Do not splash or spill liquid in the vehicle. Doing so may cause electrical components etc. to malfunction or catch fire.
- Do not get any of the SRS components or wiring in the vehicle interior wet. (→P. 148)

Electrical malfunction may cause the airbags to deploy or not function properly, resulting in death or severe injury.

■ Cleaning the interior (especially instrument panel)

Do not use polish wax or polish cleaner. The instrument panel may reflect off the windshield, obstructing the driver's view and leading to an accident, resulting in death or serious injury.

 NOTICE

■ **Cleaning detergents**

- Do not use organic substances such as benzene or gasoline, acidic or alkaline solutions, dye, bleach or other detergent. Doing so may discolor the vehicle interior or cause streaks or damage to painted surfaces.
- Do not use polish wax or polish cleaner. The instrument panel's or other interior part's painted surface may be damaged.

■ **Preventing damage to leather surfaces**

Observe the following precautions to avoid damage to and deterioration of leather surfaces.

- Remove any dust or dirt on leather surfaces immediately.
- Do not expose the vehicle to direct sunlight for extended periods of time. Park the vehicle in the shade, especially during summer.
- Do not place items made of vinyl, plastic, or that contain wax on the upholstery, as they may stick to the leather surface if the vehicle interior heats up significantly.

■ **Water on the floor**

Do not wash the vehicle floor with water.

Vehicle systems such as the audio system may be damaged if water comes into contact with electrical components under the floor of the vehicle, and may also cause the body to rust.

■ **Cleaning the inside of the rear window**

- Do not use glass cleaner to clean the rear window, as this may cause damage to the rear window defogger heater wires. Use a cloth dampened with lukewarm water to gently wipe the window clean. Wipe the window in strokes running parallel to the heater wires.
- Be careful not to scratch or damage the heater wires.

4-2. Maintenance

Maintenance requirements

To ensure safe and economical driving, day-to-day care and regular maintenance is essential. Toyota recommends the following maintenance.

■ Scheduled maintenance

Scheduled maintenance be performed at specified intervals according to the maintenance schedule.

For full details of your maintenance schedule, read the “Toyota Service Booklet” or “Toyota Warranty Booklet”.

■ Do-it-yourself maintenance

What about do-it-yourself maintenance?

Many maintenance items are easy to do yourself if you have a little mechanical ability and a few basic automotive tools.

Note, however, that some maintenance tasks require special tools and skills. These are best performed by qualified technicians. Even if you're an experienced do-it-yourself mechanic, we recommend that repairs and maintenance be conducted by any authorized Toyota dealer or repairer, or another duly qualified and equipped professional. Any authorized Toyota dealer or repairer will keep a record of maintenance, which could be useful should you ever require Warranty Service. Should you choose to select a qualified and equipped professional other than an authorized Toyota repairer to service or maintain your vehicle, we recommend that you request that a record of maintenance be kept.

■ **Where to go for maintenance service?**

In order to maintain your vehicle in the highest possible condition, Toyota recommends that maintenance service operations as well as other inspections and repairs be carried out by authorized Toyota dealers or repairers or other duly qualified and equipped professionals. For repairs and services covered by your warranty, please visit an authorized Toyota dealer or repairer, who will use genuine Toyota parts in repairing any difficulties you may encounter. There can also be advantages in utilizing authorized Toyota dealers or repairers for non-warranty repairs and services, as members of the Toyota network will be able to expertly assist you with any difficulties you may encounter.

Your Toyota dealer or repairer, or another duly qualified and equipped professional service department will perform all of the scheduled maintenance on your vehicle-reliably and economically due to their experience with Toyota vehicles.

■ **Does your vehicle need repair?**

Be on the alert for changes in performance and sounds, and visual tip-offs that indicate service is needed. Some important clues are:

- Engine misfire, stumbling, or pinging
- Appreciable loss of power
- Strange engine noises
- A fluid leak under the vehicle (However, water dripping from the air conditioning after use is normal.)
- Change in exhaust sound (This may indicate a dangerous carbon monoxide leak. Drive with the windows open and have the exhaust system checked immediately.)
- Flat-looking tires, excessive tire squeal when cornering, uneven tire wear
- Vehicle pulls to one side when driving straight on a level road
- Strange noises related to suspension movement
- Loss of brake effectiveness, spongy feeling brake pedal, pedal almost touches the floor, vehicle pulls to one side when braking

- Engine coolant temperature continually higher than normal

If you notice any of these clues, take your vehicle to any authorized Toyota dealer or repairer, or another duly qualified and equipped professional, as soon as possible. Your vehicle may need adjustment or repair.

 CAUTION

■ **If your vehicle is not properly maintained**

It could result in serious damage to the vehicle and possible serious injury or death.

■ **Warning in handling of the battery**

Battery posts, terminals and related accessories contain lead and lead compounds which are known to cause brain damage. Wash your hands after handling. (→P. 425)

4-3. Do-it-yourself maintenance

Do-it-yourself service precautions

If you perform maintenance yourself, be sure to follow the correct procedures as given in these sections.

Items	Parts and tools
Battery condition (→P. 425)	<ul style="list-style-type: none"> • Warm water • Baking soda • Grease • Conventional wrench (for terminal clamp bolts) • Distilled water
Engine coolant level (→P. 422)	<ul style="list-style-type: none"> ▶ Gasoline engine <ul style="list-style-type: none"> • “Toyota Super Long Life Coolant” or similar high quality ethylene glycol based non-silicate, non-amine, non-nitrite and non-borate coolant with long-life hybrid organic acid technology. “Toyota Super Long Life Coolant” is pre-mixed with 50% coolant and 50% deionized water. • Funnel (used only for adding coolant) ▶ Diesel engine <ul style="list-style-type: none"> • “Toyota Genuine Premium Long Life Coolant 1WW/2WW” or equivalent. “Toyota Genuine Premium Long Life Coolant 1WW/2WW” concentrated product always needs to be mixed as 50% coolant and 50% deionized water. <p>Contact any authorized Toyota dealer or repairer, or another duly qualified and equipped professional, for usage of any other approved engine coolant of matching quality.</p> <ul style="list-style-type: none"> • Funnel (used only for adding coolant)

Items	Parts and tools
Engine oil level (→P. 417)	<ul style="list-style-type: none"> ▶ Gasoline engine <ul style="list-style-type: none"> • “Toyota Genuine Motor Oil” or equivalent • Rag or paper towel, funnel (used only for adding oil) ▶ Diesel engine <ul style="list-style-type: none"> • “Toyota Genuine Motor Oil 5W-30 Premium Fuel Economy for 1WW/2WW engines” <p>Contact any authorized Toyota dealer or repairer, or another duly qualified and equipped professional, for usage of any other approved engine oil of matching quality.</p> <ul style="list-style-type: none"> • Rag or paper towel, funnel (used only for adding oil)
Fuses (→P. 457)	<ul style="list-style-type: none"> • Fuse with same amperage rating as original
Radiator, condenser and intercooler (→P. 424)	—
Tire inflation pressure (→P. 445)	<ul style="list-style-type: none"> • Tire pressure gauge • Compressed air source
Washer fluid (→P. 429)	<ul style="list-style-type: none"> • Water washer fluid containing anti-freeze (for winter use)

 CAUTION

The engine compartment contains many mechanisms and fluids that may move suddenly, become hot, or become electrically energized. To avoid death or serious injury, observe the following precautions.

■ **When working on the engine compartment**

- Keep hands, clothing, and tools away from the moving fan and engine drive belt.
- Be careful not to touch the engine, radiator, exhaust manifold, etc. right after driving as they may be hot. Oil and other fluids may also be hot.
- Do not leave anything that may burn easily, such as paper or rags, in the engine compartment.
- Do not smoke, cause sparks or expose an open flame to fuel or the battery. Fuel and battery fumes are flammable.
- Be extremely cautious when working on the battery. It contains poisonous and corrosive sulphuric acid.
- Take care because brake fluid can harm your hands or eyes and damage painted surfaces.
If fluid gets on your hands or in your eyes, flush the affected area with clean water immediately.
If you still experience discomfort, see a doctor.

■ **When working near the electric cooling fan or radiator grille**

- Vehicles without smart entry & start system: Be sure the engine switch is in the "LOCK" position.
With the engine switch in the "ON" position, the electric cooling fan may automatically start to run if the air conditioning is on and/or the coolant temperature is high. (→P. 424)

⚠ CAUTION**■ When working near the electric cooling fan or radiator grille**

- Vehicles with smart entry & start system: Be sure the “ENGINE START STOP” switch is off.
With the “ENGINE START STOP” switch in IGNITION ON mode, the electric cooling fan may automatically start to run if the air conditioning is on and/or the coolant temperature is high. (→P. 424)
- Diesel engine only: After the temperature in the engine compartment has become high, the electric cooling fan may operate even after the engine has been stopped.

■ Safety glasses

Wear safety glasses to prevent flying or falling material, fluid spray, etc. from getting in the eyes.

⚠ NOTICE**■ If you remove the air cleaner filter**

Driving with the air cleaner filter removed may cause excessive engine wear due to dirt in the air.

■ If the brake fluid level is low or high

It is normal for the brake fluid level to go down slightly as the brake pads wear or when the fluid level in the accumulator is high.
If the reservoir needs frequent refilling, it may indicate a serious problem.

4-3. Do-it-yourself maintenance

Hood

Release the lock from the inside of the vehicle to open the hood.

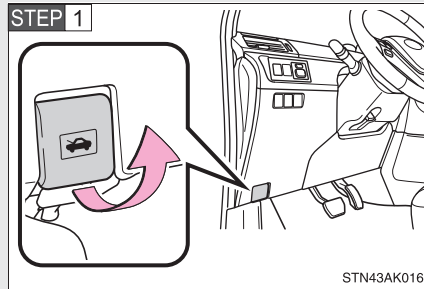

Pull the hood lock release lever.

The hood will pop up slightly.

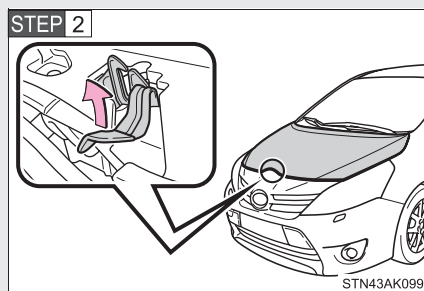

Pull up the hood catch and lift the hood.

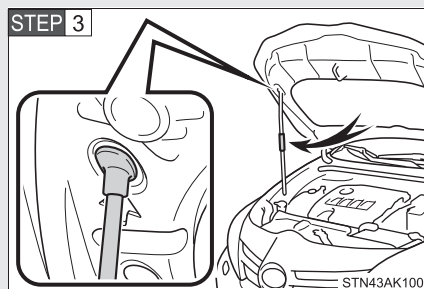

Hold the hood open by inserting the supporting rod into the slot.

When moving the supporting rod, hold the support rod cover.

 CAUTION**■ Pre-driving check**

Check that the hood is fully closed and locked.
If the hood is not locked properly, it may open while the vehicle is in motion and cause an accident, which may result in death or serious injury.

■ When moving the support rod

High temperatures in the engine compartment cause the support rod to become extremely hot.
When moving the supporting rod, be sure to hold the support rod cover to prevent burns.

■ After installing the support rod into the slot

Make sure the rod supports the hood securely, so that it will not fall down onto your head or body.

 NOTICE**■ When closing the hood**

Be sure to return the support rod to its clip before closing the hood. Closing the hood with the support rod up could cause the hood to bend.

4-3. Do-it-yourself maintenance Positioning a floor jack

When raising your vehicle with a floor jack, position the jack correctly. Improper placement may damage your vehicle or cause injury.

► Front

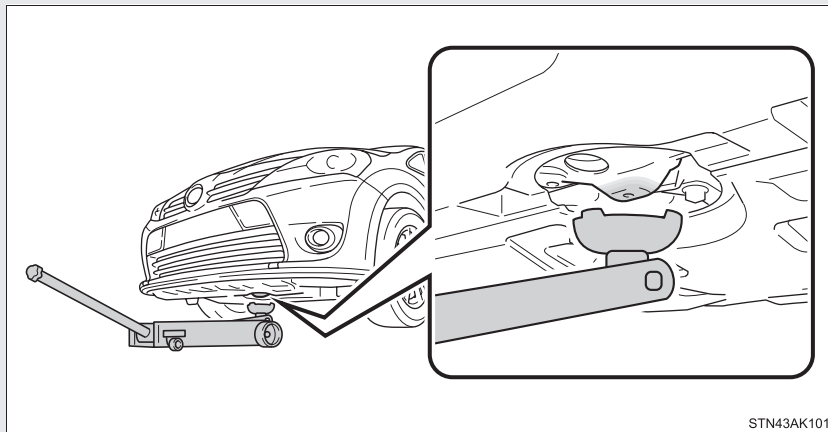

► Rear

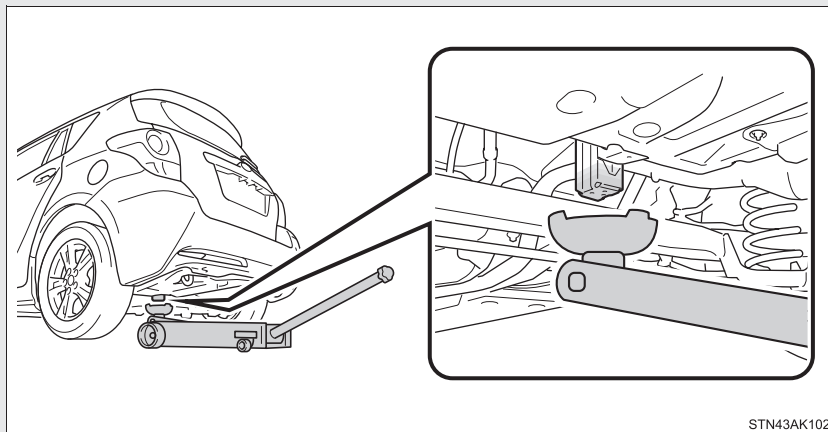

⚠ CAUTION**■ When raising your vehicle**

Make sure to observe the following to reduce the possibility of death or serious injury.

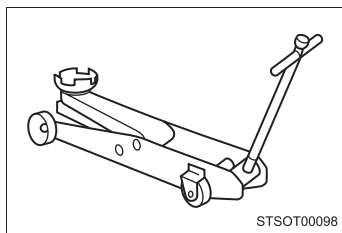

- Lift up the vehicle using a floor jack such as the one shown in the illustration.

- When using a floor jack, follow the instructions of the manual provided with the jack.
- Do not use the jack that was supplied with your vehicle.
- Do not put any part of your body or get underneath the vehicle supported only by the floor jack.
- Always use floor jack and/or automotive jack stands on a solid, flat, level surface.
- Do not start the engine while the vehicle is supported by the floor jack.
- Stop the vehicle on level firm ground, firmly set the parking brake and put the shift lever in "P" (Multidrive) or "R" (manual transmission).
- Make sure to set the floor jack properly at the jack point.
Raising the vehicle with an improperly positioned floor jack will damage the vehicle and may cause the vehicle to fall off the floor jack.
- Do not raise the vehicle while someone is in the vehicle.
- When raising the vehicle, do not place any objects on top of or underneath the floor jack.

4-3. Do-it-yourself maintenance Engine compartment

► Gasoline engine

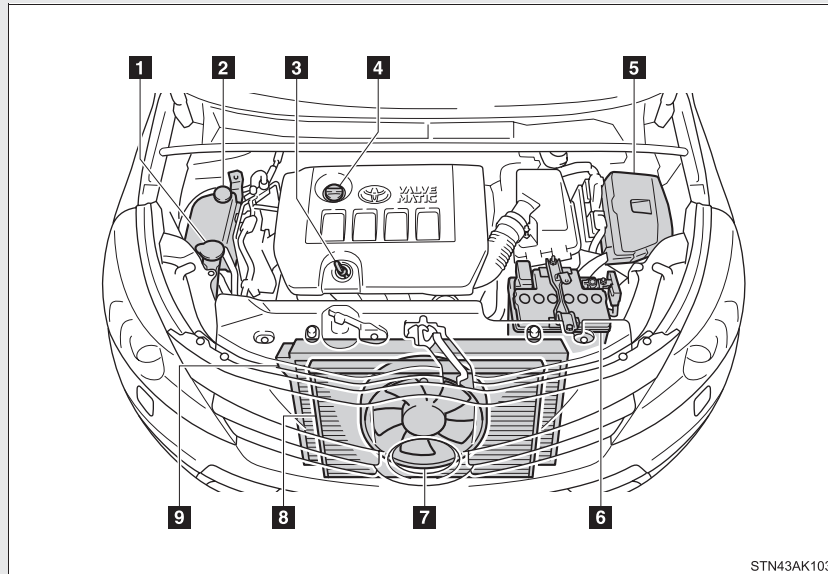

- | | |
|--|-------------------------------|
| 1 Washer fluid tank (→P. 429) | 5 Fuse box (→P. 457) |
| 2 Engine coolant reservoir (→P. 422) | 6 Battery (→P. 425) |
| 3 Engine oil level dipstick (→P. 417) | 7 Electric cooling fan |
| 4 Engine oil filler cap (→P. 419) | 8 Condenser (→P. 424) |
| | 9 Radiator (→P. 424) |

► Diesel engine

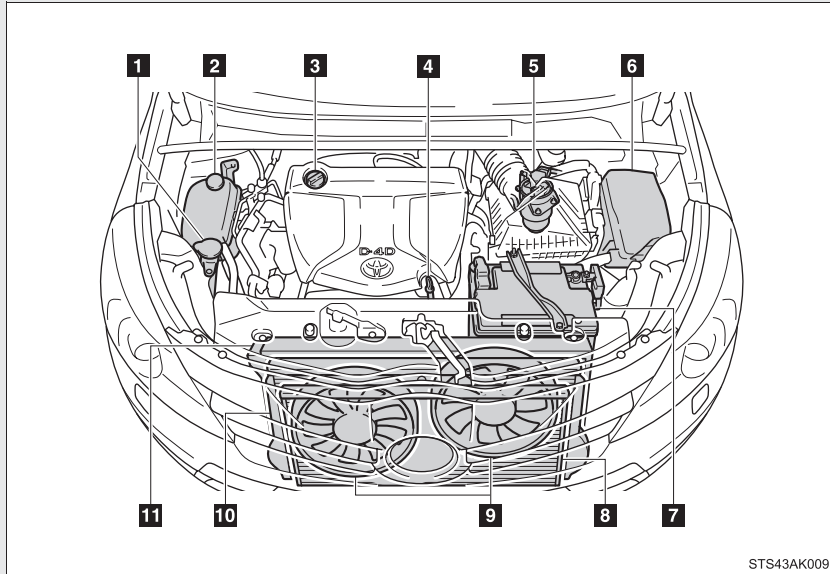

STS43AK009

- | | |
|--|---------------------------------|
| 1 Washer fluid tank (→P. 429) | 5 Fuel filter (→P. 430) |
| 2 Engine coolant reservoir (→P. 422) | 6 Fuse box (→P. 457) |
| 3 Engine oil filler cap (→P. 419) | 7 Battery (→P. 425) |
| 4 Engine oil level dipstick (→P. 417) | 8 Condenser (→P. 424) |
| | 9 Electric cooling fans |
| | 10 Intercooler (→P. 424) |
| | 11 Radiator (→P. 424) |

4

Maintenance and care

Engine compartment cover

■ Removing the engine compartment cover

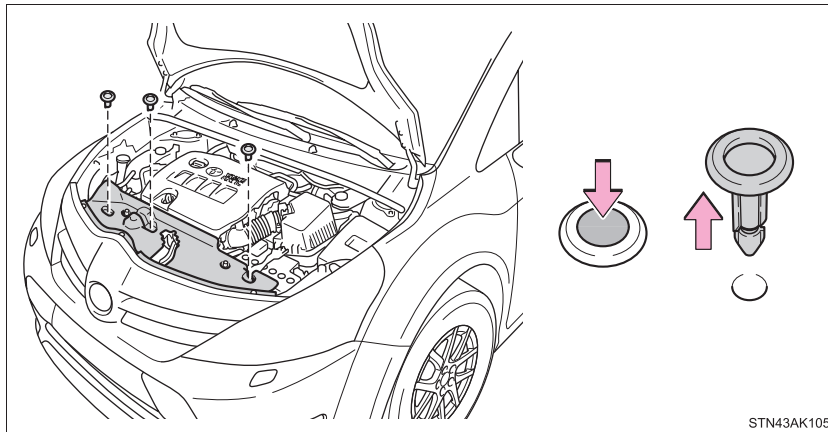

■ Installing the clips

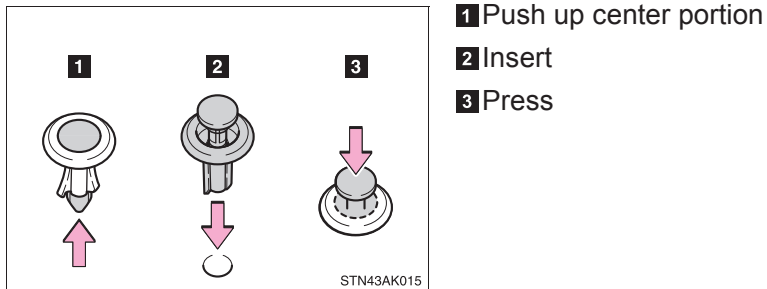

⚠ NOTICE

■ After installing an engine compartment cover

Make sure that the cover is securely installed in its original position.

Engine oil

With the engine at operating temperature and turned off, check the oil level on the dipstick.

■ Checking the engine oil

STEP 1 Park the vehicle on level ground. After warming up the engine and turning it off, wait more than 5 minutes for the oil to drain back into the bottom of the engine.

STEP 2 Hold a rag under the end and pull the dipstick out.

► Gasoline engine

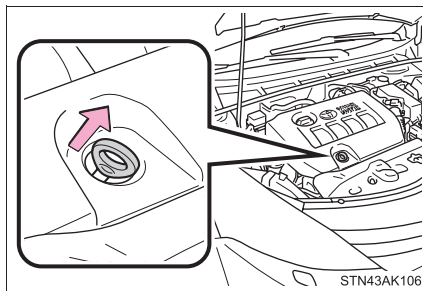

► Diesel engine

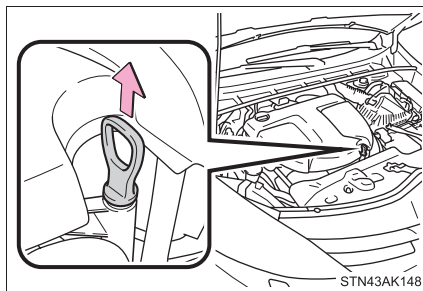

STEP 3 Wipe the dipstick clean.

4-3. Do-it-yourself maintenance

STEP 4 Reinsert the dipstick fully.

STEP 5 Holding a rag under the end, pull the dipstick out and check the oil level.

► Gasoline engine

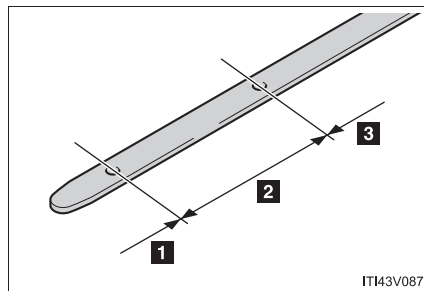

1 Low

2 Normal

3 Excessive

The shape of the dipstick may differ depending on the type of vehicle or engine.

► Diesel engine

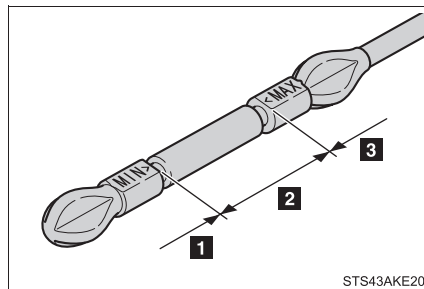

1 Low

2 Normal

3 Excessive

The shape of the dipstick may differ depending on the type of vehicle or engine.

STEP 6 Wipe the dipstick and reinsert it fully.

■ Adding engine oil

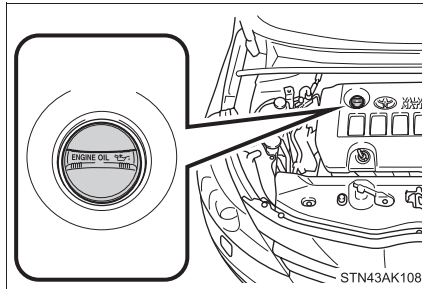

If the oil level is below or near the low level mark, add engine oil of the same type as already in the engine.

Make sure to check the oil type and prepare the items needed before adding oil.

Engine oil selection	→P. 584
Oil quantity (Low → Full)	<ul style="list-style-type: none"> ▶ Gasoline engine 1.5 L (1.6 qt., 1.3 Imp.qt.) ▶ Diesel engine 1.3 L (1.4 qt., 1.1 Imp.qt.)
Items	Clean funnel

STEP 1 Remove the oil filler cap by turning it counterclockwise.

STEP 2 Add engine oil slowly, checking the dipstick.

STEP 3 Install the oil filler cap by turning it clockwise.

■ Engine oil consumption

A certain amount of engine oil will be consumed while driving. In the following situations, oil consumption may increase, and engine oil may need to be refilled in between oil maintenance intervals.

- When the engine is new, for example directly after purchasing the vehicle or after replacing the engine
- If low quality oil or oil of an inappropriate viscosity is used
- When driving at high engine speeds or with a heavy load, when towing, or when driving while accelerating or decelerating frequently
- When leaving the engine idling for a long time, or when driving frequently through heavy traffic

■ After changing the engine oil (diesel engine only)

The engine oil maintenance should be reset. Perform the following procedures:

STEP 1 Turn the engine switch to the "ON" position (vehicles without smart entry & start system) or the "ENGINE START STOP" switch to IGNITION ON mode (vehicles with smart entry & start system) and then switch the display to the trip meter A. (→P. 224)

STEP 2 Turn the engine switch to the "LOCK" position (vehicles without smart entry & start system) or "ENGINE START STOP" switch off (vehicles with smart entry & start system).



While pressing the display change button (→P. 224), turn the engine switch to the "ON" position (vehicles without smart entry & start system) or the "ENGINE START STOP" switch to IGNITION ON mode (vehicles with smart entry & start system) and the message shown in the illustration will appear on the display.

STEP 4 Continue to press and hold the button until the meter displays "00000", and then the system reset will be completed.

⚠ CAUTION**■ Used engine oil**

- Used engine oil contains potentially harmful contaminants which may cause skin disorders such as inflammation or skin cancer, so care should be taken to avoid prolonged and repeated contact. To remove used engine oil from your skin, wash thoroughly with soap and water.
- Dispose of used oil and filters only in a safe and acceptable manner. Do not dispose of used oil and filters in household trash, in sewers or onto the ground. Call any authorized Toyota dealer or repairer, or another duly qualified and equipped professional, service station or auto parts store for information concerning recycling or disposal.
- Do not leave used engine oil within the reach of children.

⚠ NOTICE**■ To prevent serious engine damage**

Check the oil level on regular basis.

■ When replacing the engine oil

- Be careful not to spill engine oil on the vehicle components.
- Avoid overfilling, as the engine could be damaged.
- Check the oil level on the dipstick every time you refill the vehicle.
- Be sure the engine oil filler cap is properly tightened.

■ Engine oil (diesel engine only)

Using engine oil other than “Toyota Genuine Motor Oil 5W-30 Premium Fuel Economy for 1WW/2WW engines” or any other approved engine oil, may damage the catalytic converter.

If “Toyota Genuine Motor Oil 5W-30 Premium Fuel Economy for 1WW/2WW engines” or any other approved engine oils are not available at the time, up to 1 L of ACEA C3 can be used to refill. (→P. 589)

Engine coolant

The coolant level is satisfactory if it is between the “FULL” and “LOW” lines on the reservoir when the engine is cold.

► Gasoline engine

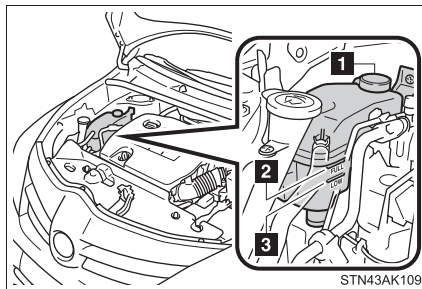

1 Reservoir cap

2 “FULL”

3 “LOW”

If the level is on or below the “LOW” line, add coolant up to the “FULL” line.

► Diesel engine

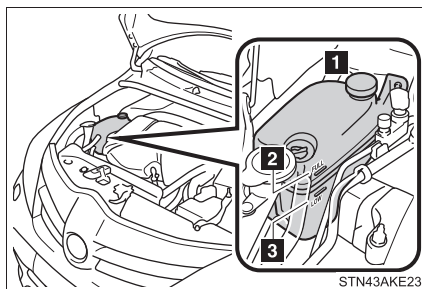

1 Reservoir cap

2 “FULL”

3 “LOW”

If the level is on or below the “LOW” line, add coolant up to the “FULL” line.

■ If the coolant level drops within a short time after replenishing

Visually check the radiator, hoses, reservoir cap, radiator cap, drain cock and water pump.

If you cannot find a leak, have any authorized Toyota dealer or repairer, or another duly qualified and equipped professional, test the cap and check for leaks in the cooling system.

■ Coolant selection

▶ Gasoline engine

Only use “Toyota Super Long Life Coolant” or similar high quality ethylene glycol based non-silicate, non-amine, non-nitrite, and non-borate coolant with long-life hybrid organic acid technology.

“Toyota Super Long Life Coolant” is a mixture of 50% coolant and 50% deionized water. (Enabled: -35°C [-31°F])

▶ Diesel engine

Only use “Toyota Genuine Premium Long Life Coolant 1WW/2WW” or equivalent.

“Toyota Genuine Premium Long Life Coolant 1WW/2WW” concentrated product always needs to be mixed as 50% coolant and 50% deionized water. (Enabled: -35°C [-31°F])

For more details about engine coolant, contact any authorized Toyota dealer or repairer, or another duly qualified and equipped professional.

CAUTION

■ When the engine is hot

Do not remove the coolant reservoir cap.

The cooling system may be under pressure and may spray hot coolant if the cap is removed, causing serious injuries, such as burns.

 NOTICE

■ **When adding engine coolant**

Coolant is neither plain water nor straight antifreeze. The correct mixture of water and antifreeze must be used to provide proper lubrication, corrosion protection and cooling. Be sure to read the antifreeze or coolant label.

■ **If you spill coolant**

Be sure to wash it off with water to prevent damage to parts or paint.

Radiator, condenser and intercooler

Check the radiator, condenser and intercooler (diesel engine only) and clear any foreign objects.

If any of the above parts are extremely dirty or you are not sure of their condition, have your vehicle checked by any authorized Toyota dealer or repairer, or another duly qualified and equipped professional.

 CAUTION

■ **When the engine is hot**







Do not touch the radiator, condenser or intercooler, as they may be hot and cause serious injuries, such as burns.

Battery

Check the battery as follows.

■ **Caution symbols**

The meanings of each caution symbol on the top of the battery are as follows:

	No smoking, no naked flames, no sparks		Battery acid
	Shield eyes		Note operating instructions
	Keep away from children		Explosive gas

■ **Battery exterior**

Make sure that the battery terminals are not corroded and that there are no loose connections, cracks, or loose clamps.

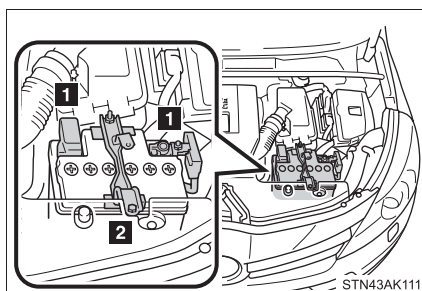

- 1 Terminals
- 2 Hold-down clamp

■ **Checking battery fluid (batteries with vent plugs)**

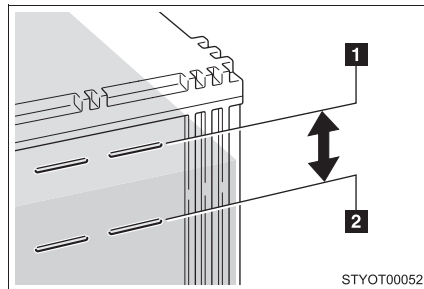

Check that the level is between the “MAX” and “MIN” lines.

1 “MAX” line

2 “MIN” line

If the fluid level is at or below the “MIN” line, add distilled water.

■ **Adding distilled water (batteries with vent plugs)**

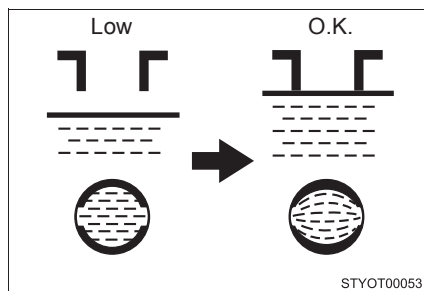

STEP 1 Remove the vent plug.

STEP 2 Add distilled water.

If the “MAX” line cannot be seen, check the fluid level by looking directly at the cell.

STEP 3 Put the vent plug back on and close it securely.

■ Before recharging

When recharging, the battery produces hydrogen gas which is flammable and explosive. Therefore, before recharging:

- If recharging with the battery installed on the vehicle, be sure to disconnect the ground cable.
- Make sure the power switch on the charger is off when connecting and disconnecting the charger cables to the battery.

■ After recharging the battery (vehicles with smart entry & start system)

The engine may not start. Follow the procedure below to initialize the system.

STEP 1 Shift the shift lever to “P” (Multidrive) or depress the brake pedal with the shift lever in “N” (manual transmission).

STEP 2 Open and close any of the doors.

STEP 3 Restart the engine.

⚠ CAUTION

■ Chemicals in the battery

A battery contains poisonous and corrosive sulphuric acid and may produce hydrogen gas which is flammable and explosive. To reduce the risk of death or serious injury, take the following precautions while working on or near battery:

- Do not cause sparks by touching the battery terminals with tools.
- Do not smoke or light a match near the battery.
- Avoid contact with eyes, skin and clothes.
- Never inhale or swallow electrolyte.
- Wear protective safety glasses when working near the battery.
- Keep children away from the battery.

 CAUTION

■ **Where to safely charge the battery**

Always charge the battery in an open area. Do not charge the battery in a garage or closed room where there is not sufficient ventilation.

■ **How to recharge the battery (batteries without vent plugs)**

Only perform a slow charge (5 A or less). The battery may explode if charged at a quicker rate.

■ **Emergency measures regarding electrolyte**

● **If electrolyte gets in your eyes**

Flush your eyes with clean water for at least 15 minutes and get immediate medical attention. If possible, continue to apply water with a sponge or cloth while traveling to the nearest medical facility.

● **If electrolyte gets on your skin**

Wash the affected area thoroughly. If you feel pain or burning, get medical attention immediately.

● **If electrolyte gets on your clothes**

It can soak through clothing on to your skin. Immediately take off the clothing and follow the procedure above if necessary.

● **If you accidentally swallow electrolyte**

Drink a large quantity of water or milk. Get emergency medical attention immediately.

 NOTICE

■ **When recharging the battery**

Never recharge the battery while the engine is running. Also, be sure all accessories are turned off.

■ **When adding distilled water (batteries with vent plugs)**

Avoid overfilling. Water spilled during battery recharging may cause corrosion.

Washer fluid

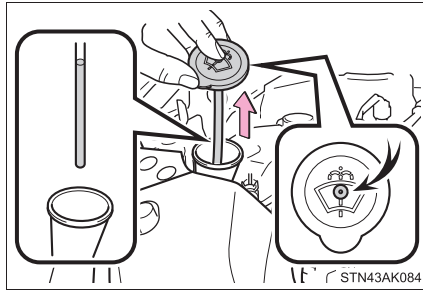

If the fluid level is extremely low, add washer fluid.

Raise the cap keeping your finger pressed down on the hole in the center and check the fluid level in the tube.

CAUTION

■ When refilling the washer fluid

Do not refill the washer fluid when the engine is hot or running, as the washer fluid contains alcohol and may catch fire if spilled on the engine, etc.

NOTICE

■ Do not use any fluid other than washer fluid

Do not use soapy water or engine antifreeze instead of washer fluid. Doing so may cause streaking on the vehicle's painted surfaces.

■ Diluting washer fluid

Dilute washer fluid with water as necessary. Refer to the freezing temperatures listed on the label of the washer fluid bottle.

Fuel filter (diesel engine only)

The water in the fuel filter needs to be drained every 20000 km (12000 miles).

Have the fuel filter drained by any authorized Toyota dealer or repairer, or another duly qualified and equipped professional.

 **NOTICE**

■ When there is water in the fuel filter

Do not drive continuously with water accumulated in the fuel filter. This will cause damage to the fuel injection pump.

4-3. Do-it-yourself maintenance

Tires

Replace the tires when the treadwear indicators show.

■ Checking tires

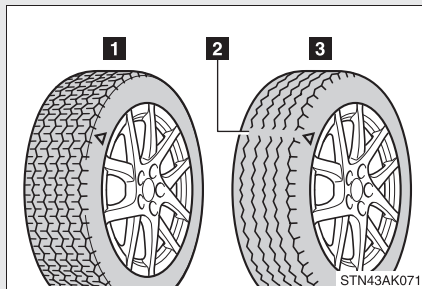

- 1 New tread
- 2 Treadwear indicator
- 3 Worn tread

The location of treadwear indicators is shown by the “TWI” or “△” marks, etc., molded on the sidewall of each tire.

Check spare tire condition and inflation pressure if not rotated.

■ Tire rotation

- ▶ Vehicles with a spare tire of different wheel type from the installed tires or an emergency tire puncture repair kit (vehicles with or without tire pressure warning system)

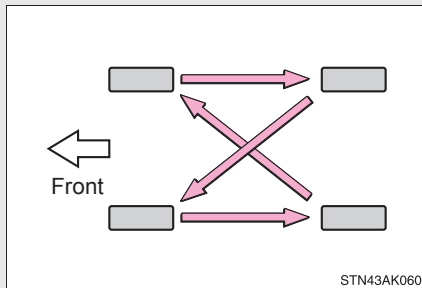

Rotate the tires in the order shown.

To equalize tire wear and help extend tire life, Toyota recommends that you rotate your tires approximately every 10000 km (6000 miles).

- ▶ Vehicles with a spare tire of the same wheel type from the installed tires (vehicles without tire pressure warning system)

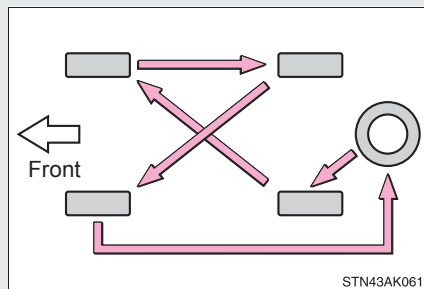

Rotate the tires in the order shown.

To equalize tire wear and help extend tire life, Toyota recommends that you rotate your tires approximately every 10000 km (6000 miles).

■ Tire pressure warning system (if equipped)

Your vehicle is equipped with a tire pressure warning system that uses tire pressure warning valves and transmitters to detect low tire inflation pressure before serious problems arise.

If the tire pressure drops below a predetermined level, the driver is warned by a warning light. (→P. 503)

Installing tire pressure warning valves and transmitters (if equipped)

When replacing tires or wheels, tire pressure warning valves and transmitters must also be installed.

When new tire pressure warning valves and transmitters are installed, new ID codes must be registered in the tire pressure warning computer and the tire pressure warning system must be initialized. Have tire pressure warning valve and transmitter ID codes registered by any authorized Toyota dealer or repairer, or another duly qualified and equipped professional. (→P. 435)

Initializing the tire pressure warning system (if equipped)

■ The tire pressure warning system must be initialized in the following circumstances:

- When rotating front and rear tires which have different tire inflation pressures
- When the tire inflation pressure is changed such as when changing traveling speed
- When changing the tire size

When the tire pressure warning system is initialized, the current tire inflation pressure is set as the benchmark pressure.

■ How to initialize the tire pressure warning system (if equipped)

STEP 1 Park the vehicle in a safe place and turn the engine switch to the “LOCK” position (vehicles without smart entry & start system) or the “ENGINE START STOP” switch off (vehicles with smart entry & start system).

Initialization cannot be performed while the vehicle is moving.

STEP 2 Adjust the tire inflation pressure to the specified cold tire inflation pressure level. (→P. 595)

Make sure to adjust the tire pressure to the specified cold tire inflation pressure level. The tire pressure warning system will operate based on this pressure level.

STEP 3 Turn the engine switch to the “ON” position (vehicles without smart entry & start system) or the “ENGINE START STOP” switch to IGNITION ON mode (vehicles with smart entry & start system).

4-3. Do-it-yourself maintenance

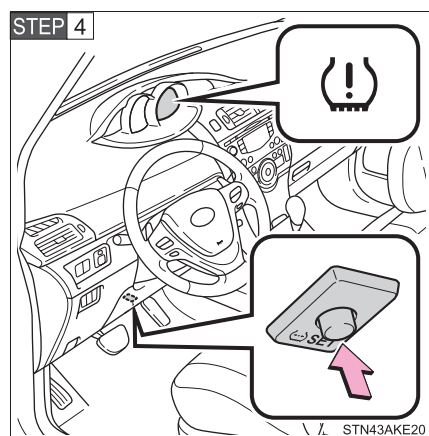

Press and hold the tire pressure warning reset switch until the tire pressure warning light blinks slowly 3 times.

STEP 5 Vehicles without smart entry & start system: Wait for a few minutes with the engine switch in the “ON” position and then turn the engine switch to the “ACC” or “LOCK” position.

Vehicles with smart entry & start system: Wait for a few minutes with the “ENGINE START STOP” switch in IGNITION ON mode and then turn the “ENGINE START STOP” switch off.

Registering ID codes (vehicles with the tire pressure warning system)

The tire pressure warning valve and transmitter is equipped with a unique ID code. When replacing a tire pressure warning valve and transmitter, it is necessary to register the ID code. Have the ID code registered by any authorized Toyota dealer or repairer, or another duly qualified and equipped professional.

■ When to replace your vehicle's tires

Tires should be replaced if:

- You have tire damage such as cuts, splits, cracks deep enough to expose the fabric or bulges indicating internal damage
- A tire goes flat repeatedly or cannot be properly repaired due to the size or location of a cut or other damage

If you are not sure, consult with any authorized Toyota dealer or repairer, or another duly qualified and equipped professional.

■ Replacing tire and wheels (vehicles with the tire pressure warning system)

If the ID code of the tire pressure warning valve and transmitter is not registered, the tire pressure warning system will not work properly. After driving for about 10 minutes, the tire pressure warning light blinks for 1 minute and stays on to indicate a system malfunction.

■ Tire life

Any tires over 6 years old must be checked by a qualified technician even if they have seldom or never been used or damage is not obvious.

■ **Routine tire inflation pressure checks (vehicles with the tire pressure warning system)**

The tire pressure warning system does not replace routine tire inflation pressure checks. Make sure to check tire inflation pressure as part of your routine of daily vehicle checks.

■ **Initializing the tire pressure warning system (if equipped)**

Initialize the system with the tire inflation pressure adjusted to the specified level.

■ **If the tread depth wears down to 4 mm (0.16 in.) or more on snow tires**

The effectiveness of snow tires is lost.

■ **When initialization of the tire pressure warning system has failed (if equipped)**

Initialization can be completed in a few minutes. However, in the following cases, the settings have not been recorded and the system will not operate properly. If repeated attempts to record tire inflation pressure settings are unsuccessful, have the vehicle inspected by any authorized Toyota dealer or repairer, or another duly qualified and equipped professional.

- When operating the tire pressure warning reset switch, the tire pressure warning light does not blink 3 times.
- After driving for a certain period of time since the initialization has been completed, the warning light comes on after blinking for 1 minute.

■ Tire pressure warning system certification

The latest “DECLARATION of CONFORMITY” (DoC) is available at the following address:

<http://www.globaldenso.com/en/products/oem/index.html>



<p>Hereby, DENSO CORPORATION declares that this 13BDX is in compliance with the essential requirements and other relevant provisions of Directive 1999/5/EC.</p>
<p>DENSO CORPORATION vakuuttaa täten että 13BDX tyyppinen laite on direktiivin 1999/5/EY oleellisten vaatimusten ja sitä koskevien direktiivin muiden ehtojen mukainen.</p>
<p>Hierbij verklaart DENSO CORPORATION dat het toestel 13BDX in overeenstemming is met de essentiële eisen en de andere relevante bepalingen van richtlijn 1999/5/EG.</p>
<p>Par la présente DENSO CORPORATION déclare que l'appareil 13BDX est conforme aux exigences essentielles et aux autres dispositions pertinentes de la directive 1999/5/CE.</p>
<p>Härmed intygar DENSO CORPORATION att denna 13BDX står i överensstämmelse med de väsentliga egenskapskrav och övriga relevanta bestämmelser som framgår av direktiv 1999/5/EG.</p>
<p>Undertegnede DENSO CORPORATION erklærer herved, at følgende udstyr 13BDX overholder de væsentlige krav og øvrige relevante krav i direktiv 1999/5/EF.</p>
<p>Hiermit erklärt DENSO CORPORATION, dass sich das Gerät 13BDX in Übereinstimmung mit den grundlegenden Anforderungen und den übrigen einschlägigen Bestimmungen der Richtlinie 1999/5/EG befindet.</p>
<p>ΜΕ ΤΗΝ ΠΑΡΟΥΣΑ DENSO CORPORATION ΔΗΛΩΝΕΙ ΟΤΙ 13BDX ΣΥΜΜΟΡΦΩΝΕΤΑΙ ΠΡΟΣ ΤΙΣ ΟΥΣΙΩΔΕΙΣ ΑΠΑΙΤΗΣΕΙΣ ΚΑΙ ΤΙΣ ΛΟΙΠΕΣ ΣΧΕΤΙΚΕΣ ΔΙΑΤΑΞΕΙΣ ΤΗΣ ΟΔΗΓΙΑΣ 1999/5/ΕΚ.</p>
<p>Con la presente DENSO CORPORATION dichiara che questo 13BDX è conforme ai requisiti essenziali ed alle altre disposizioni pertinenti stabilite dalla direttiva 1999/5/CE.</p>
<p>Por medio de la presente DENSO CORPORATION declara que el 13BDX cumple con los requisitos esenciales y cualesquiera otras disposiciones aplicables o exigibles de la Directiva 1999/5/CE.</p>

4-3. Do-it-yourself maintenance

DENSO CORPORATION declara que este 13BDX está conforme com os requisitos essenciais e outras disposições da Directiva 1999/5/CE.
Hawnhekk, DENSO CORPORATION, jiddikjara li dan 13BDX jikkonforma mal-htigijiet essenzjali u ma provvedimenti oħrajn relevanti li hemm fid-Direttiva 1999/5/EC.
Käesolevaga kinnitab DENSO CORPORATION seadme 13BDX vastavust direktiivi 1999/5/EÜ põhinõuetele ja nimetatud direktiivist tulenevatele teistele asjakohastele sätetele.
Alulirott, DENSO CORPORATION nyilatkozom, hogy a 13BDX megfelel a vonatkozó alapvető követelményeknek és az 1999/5/EC irányelv egyéb előírásainak.
DENSO CORPORATION tímto vyhlasuje, že 13BDX splňa základné požiadavky a všetky príslušné ustanovenia Smernice 1999/5/ES.
DENSO CORPORATION tímto prohlašuje, že tento 13BDX je ve shodě se základními požadavky a dalšími příslušnými ustanoveními směrnice 1999/5/ES.
DENSO CORPORATION izjavlja, da je ta 13BDX v skladu z bistvenimi zahtevami in ostalimi relevantnimi določili direktive 1999/5/ES.
Šiuo DENSO CORPORATION deklaruoja, kad šis 13BDX atitinka esminius reikalavimus ir kitas 1999/5/EB Direktyvos nuostatas.
Ar šo DENSO CORPORATION deklarē, ka 13BDX atbilst Direktīvas 1999/5/EK būtiskajām prasībām un citiem ar to saistītajiem noteikumiem.
Niniejszym DENSO CORPORATION oświadcza, że 13BDX jest zgodny z zasadniczymi wymogami oraz pozostałymi stosownymi postanowieniami Dyrektywy 1999/5/EC.
Hér með lýsir DENSO CORPORATION yfir því að 13BDX er í samræmi við grunnkröfur og aðrar kröfur, sem gerðar eru í tilskipun 1999/5/EC.
DENSO CORPORATION erklærer herved at udstyret 13BDX er i samsvar med de grundlæggende krav og øvrige relevante krav i direktiv 1999/5/EF.

4-3. Do-it-yourself maintenance

<p>С настоящето, DENSO CORPORATION, декларира, че 13BDX е в съответствие със съществените изисквания и другите приложими разпоредби на Директива 1999/5/EC.</p>
<p>Prin prezenta, DENSO CORPORATION, declară că aparatul 13BDX este în conformitate cu cerințele esențiale și cu alte prevederi pertinente ale Directivei 1999/5/CE.</p>
<p>Ovim, DENSO CORPORATION, izjavljuje da ovaj 13BDX je usklađen sa bitnim zahtjevima i drugim relevantnim odredbama Direktive 1999/5/EC.</p>
<p>Ovim, DENSO CORPORATION, deklarirše da je 13BDX u skladu sa osnovnim zahtevima i ostalim relevantnim odredbama Direktive 1999/5/EC.</p>
<p>Ovim DENSO CORPORATION, izjavljuje da je 13BDX u skladu s bitnim zahtjevima i drugim relevantnim odredbama Direktive 1999/5/EC i Pravilnika o RiTT opremi (NN 25/2012).</p>
<p>Nepermjet kesaj, DENSO CORPORATION, deklarorj qe ky 13BDX eshte ne pajtim me kerkesat thebesore dhe dispozitat e tjera perkatese te Direktives 1999/5/EC.</p>

4-3. Do-it-yourself maintenance

The latest “DECLARATION of CONFORMITY” (DoC) is available at the following:

DoC address: <http://www.pacific-ind.co.jp/eng/products/car/tpms/doc/>

C € 0891

Hereby, PACIFIC INDUSTRIAL CO.,LTD., declares that this PMV-C210 is in compliance with the essential requirements and other relevant provisions of Directive 1999/5/EC.
PACIFIC INDUSTRIAL CO.,LTD. vakuuttaa täten että PMV-C210 tyyppinen laite on direktiivin 1999/5/EY oleellisten vaatimusten ja sitä koskevien direktiivin muiden ehtojen mukainen.
Hierbij verklaart PACIFIC INDUSTRIAL CO.,LTD. dat het toestel PMV-C210 in overeenstemming is met de essentiële eisen en de andere relevante bepalingen van richtlijn 1999/5/EG.
Par la présente PACIFIC INDUSTRIAL CO.,LTD. déclare que l'appareil PMV-C210 est conforme aux exigences essentielles et aux autres dispositions pertinentes de la directive 1999/5/CE.
Härmed intygar PACIFIC INDUSTRIAL CO.,LTD. att denna PMV-C210 står i överensstämmelse med de väsentliga egenskapskrav och övriga relevanta bestämmelser som framgår av direktiv 1999/5/EG.
Undertegnede PACIFIC INDUSTRIAL CO.,LTD. erklærer herved, at følgende udstyr PMV-C210 overholder de væsentlige krav og øvrige relevante krav i direktiv 1999/5/EF.
Hiermit erkläre PACIFIC INDUSTRIAL CO.,LTD., dass sich das Gerät PMV-C210 in Übereinstimmung mit den grundlegenden Anforderungen und den übrigen einschlägigen Bestimmungen der Richtlinie 1999/5/EG befindet.
ΜΕ ΤΗΝ ΠΑΡΟΥΣΑ PACIFIC INDUSTRIAL CO.,LTD. ΔΗΛΩΝΕΙ ΟΤΙ PMV-C210 ΣΥΜΜΟΡΦΩΝΕΤΑΙ ΠΡΟΣ ΤΙΣ ΟΥΣΙΩΔΕΙΣ ΑΠΑΙΤΗΣΕΙΣ ΚΑΙ ΤΙΣ ΛΟΙΠΕΣ ΣΧΕΤΙΚΕΣ ΔΙΑΤΑΞΕΙΣ ΤΗΣ ΟΔΗΓΙΑΣ 1999/5/ΕΚ.
Con la presente PACIFIC INDUSTRIAL CO.,LTD. dichiara che questo PMV-C210 è conforme ai requisiti essenziali ed alle altre disposizioni pertinenti stabilite dalla direttiva 1999/5/CE.
Por medio de la presente PACIFIC INDUSTRIAL CO.,LTD. declara que el PMV-C210 cumple con los requisitos esenciales y cualesquiera otras disposiciones aplicables o exigibles de la Directiva 1999/5/CE.

4-3. Do-it-yourself maintenance

PACIFIC INDUSTRIAL CO.,LTD. declara que este PMV-C210 está conforme com os requisitos essenciais e outras disposições da Directiva 1999/5/CE.
Hawnhekk, PACIFIC INDUSTRIAL CO.,LTD., jiddikjara li dan PMV-C210 jikkonforma mal-htúgijiet essenzjali u ma provvedimentí oħrajn relevanti li hemm fid-Dirrettiva 1999/5/EC.
Käesolevaga kinnitab PACIFIC INDUSTRIAL CO.,LTD. seadme PMV-C210 vastavust direktiivi 1999/5/EÜ põhinõuetele ja nimetatud direktiivist tulenevatele teistele asjakohastele sätetele.
Alulirott, PACIFIC INDUSTRIAL CO.,LTD. nyilatkozom, hogy a PMV-C210 megfelel a vonatkozó alapvető követelményeknek és az 1999/5/EC irányelv egyéb előírásainak.
PACIFIC INDUSTRIAL CO.,LTD. týmto vyhlasuje, že PMV-C210 spĺňa základné požiadavky a všetky príslušné ustanovenia Smernice 1999/5/ES.
PACIFIC INDUSTRIAL CO.,LTD. tímto prohlašuje, že tento PMV-C210 je ve shodě se základními požadavky a dalšími příslušnými ustanoveními směrnice 1999/5/ES.
PACIFIC INDUSTRIAL CO.,LTD. izjavlja, da je ta PMV-C210 v skladu z bistvenimi zahtevami in ostalimi relevantnimi določili direktive 1999/5/ES.
Šiuo PACIFIC INDUSTRIAL CO.,LTD. deklaruoja, kad šis PMV-C210 atitinka esminius reikalavimus ir kitas 1999/5/EB Direktyvos nuostatas.
Ar šo PACIFIC INDUSTRIAL CO.,LTD. deklarē, ka PMV-C210 atbilst Direktīvas 1999/5/EK būtiskajām prasībām un citiem ar to saistītajiem noteikumiem.
Niniejszym PACIFIC INDUSTRIAL CO.,LTD. oświadcza, że PMV-C210 jest zgodny z zasadniczymi wymogami oraz pozostałymi stosownymi postanowieniami Dyrektywy 1999/5/EC.
Hér með lýsir PACIFIC INDUSTRIAL CO.,LTD. yfir því að PMV-C210 er í samræmi við grunnkröfur og aðrar kröfur, sem gerðar eru í tilskipun 1999/5/EC.
PACIFIC INDUSTRIAL CO.,LTD. erklærer herved at utstyret PMV-C210 er i samsvar med de grunnleggende krav og øvrige relevante krav i direktiv 1999/5/EF.

4

Maintenance and care

4-3. Do-it-yourself maintenance

<p>С настоящето, PACIFIC INDUSTRIAL CO.,LTD., декларира, че PMV-C210 е в съответствие със съществените изисквания и другите приложими разпоредби на Директива 1999/5/EC.</p>
<p>Prin prezenta, PACIFIC INDUSTRIAL CO.,LTD., declară că aparatul PMV-C210 este în conformitate cu cerințele esențiale și cu alte prevederi pertinente ale Directivei 1999/5/CE.</p>
<p>Ovim, PACIFIC INDUSTRIAL CO.,LTD., izjavjuje da ovaj PMV-C210 je usklađen sa bitnim zahtjevima i drugim relevantnim odredbama Direktive 1999/5/EC.</p>
<p>Ovim, PACIFIC INDUSTRIAL CO.,LTD., deklarirše da je PMV-C210 u skladu sa osnovnim zahtevima i ostalim relevantnim odredbama Direktive 1999/5/EC.</p>
<p>Ovim PACIFIC INDUSTRIAL CO.,LTD., izjavjuje da je PMV-C210 u skladu s bitnim zahtjevima i drugim relevantnim odredbama Direktive 1999/5/EC.</p>
<p>Me anë të kësaj, PACIFIC INDUSTRIAL CO, LTD., Deklaron se ky PMV-C210 është në përputhje me kërkesat themelore dhe dispozitat e tjera përkatëse të direktivës 1999/5/EC.</p>

► Vehicles sold in Serbia



 CAUTION**■ When inspecting or replacing tires**

Observe the following precautions to prevent accidents. Failure to do so may cause damage to parts of the drive train, as well as dangerous handling characteristics, which may lead to an accident resulting in death or serious injury.

- Do not mix tires of different makes, models or tread patterns. Also, do not mix tires of remarkably different treadwear.
- Do not use tire sizes other than those recommended by Toyota.
- Do not mix differently constructed tires (radial, bias-belted or bias-ply tires).
- Do not mix summer, all season and winter tires.
- Do not use tires that have been used on another vehicle. Do not use tires if you do not know how they were used previously.

■ When initializing the tire pressure warning system (if equipped)

Do not operate the tire pressure warning reset switch without first adjusting the tire inflation pressure to the specified level. Otherwise, the tire pressure warning light may not come on even if the tire inflation pressure is low, or it may come on when the tire inflation pressure is actually normal.

 NOTICE

■ **Repairing or replacing tires, wheels, tire pressure warning valves, transmitters and tire valve caps (vehicles with the tire pressure warning system)**

- When removing or fitting the wheels, tires or the tire pressure warning valves and transmitters, contact any authorized Toyota dealer or repairer, or another duly qualified and equipped professional as the tire pressure warning valves and transmitters may be damaged if not handled correctly.
- Make sure to install the tire valve caps. If the tire valve caps are not installed, water could enter the tire pressure warning valves and the tire pressure warning valves could be bound.
- When replacing tire valve caps, do not use tire valve caps other than those specified. The cap may become stuck.

■ **To avoid damage to the tire pressure warning valves and transmitters (vehicles with the tire pressure warning system)**

When a tire is repaired with liquid sealants, the tire pressure warning valve and transmitter may not operate properly. If a liquid sealant is used, contact any authorized Toyota dealer or repairer, or another duly qualified and equipped professional or other qualified service shop as soon as possible. After use of liquid sealant, make sure to replace the tire pressure warning valve and transmitter when repairing or replacing the tire. (→P. 432)

■ **Driving on rough roads**

Take particular care when driving on roads with loose surfaces or pot holes. These conditions may cause losses in tire inflation pressure, reducing the cushioning ability of the tires. In addition driving on rough roads may cause damage to the tires themselves, as well as the vehicle's wheels and body.

■ **If tire inflation pressures become low while driving**

Do not continue driving, or your tires and/or wheels may be ruined.

4-3. Do-it-yourself maintenance

Tire inflation pressure

Make sure to maintain the proper tire inflation pressure. Tire inflation pressure should be checked at least once per month. However, Toyota recommends that tire inflation pressure be checked once every two weeks. (→P. 595)

■ Effects of incorrect tire inflation pressure

Driving with incorrect tire inflation pressure may result in the following:

- Reduced fuel economy
- Reduced driving comfort and poor handling
- Reduced tire life due to wear
- Reduced safety
- Damage to the drive train

If a tire needs frequent refilling, have it checked by any authorized Toyota dealer or repairer, or another duly qualified and equipped professional.

■ Instructions for checking tire inflation pressure

When checking tire inflation pressure, observe the following:

- Check only when the tires are cold.
If your vehicle has been parked for at least 3 hours and has not been driven for more than 1.5 km or 1 mile, you will get an accurate cold tire inflation pressure reading.
- Always use a tire pressure gauge.
It is difficult to judge if a tire is properly inflated based only on its appearance.
- It is normal for the tire inflation pressure to be higher after driving as heat is generated in the tire. Do not reduce tire inflation pressure after driving.
- Passengers and luggage weight should be placed so that the vehicle is balanced.

 CAUTION

■ **Proper inflation is critical to save tire performance**

Keep your tires properly inflated.

If the tires are not properly inflated, the following conditions may occur which could lead to an accident resulting in death or serious injury:

- Excessive wear
- Uneven wear
- Poor handling
- Possibility of blowouts resulting from overheated tires
- Air leaking from between tire and wheel
- Wheel deformation and/or tire damage
- Greater possibility of tire damage while driving (due to road hazards, expansion joints, sharp edges in the road, etc.)

 NOTICE

■ **When inspecting and adjusting tire inflation pressure**

Be sure to reinstall the tire valve caps.

If a valve cap is not installed, dirt or moisture may get into the valve and cause an air leak, resulting in decreased tire inflation pressure.

4-3. Do-it-yourself maintenance

Wheels

If a wheel is bent, cracked or heavily corroded, it should be replaced. Otherwise, the tire may separate from the wheel or cause loss of handling control.

■ Wheel selection

When replacing wheels, care should be taken to ensure that they are equivalent to those removed in load capacity, diameter, rim width, and inset*.

Replacement wheels are available at any authorized Toyota dealer or repairer, or another duly qualified and equipped professional.

*: Conventionally referred to as "offset".

Toyota does not recommend using:

- Wheels of different sizes or types
- Used wheels
- Bent wheels that have been straightened

■ Aluminum wheel precautions (if equipped)

- Use only Toyota wheel nuts and wrenches designed for use with your aluminum wheels.
- When rotating, repairing or changing your tires, check that the wheel nuts are still tight after driving 1600 km (1000 miles).
- Be careful not to damage the aluminum wheels when using tire chains.
- Use only Toyota genuine balance weights or equivalent and a plastic or rubber hammer when balancing your wheels.

■ **When removing the wheel ornament (vehicles with the wheel cap clip)**

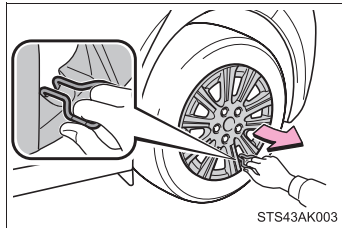

Remove the wheel ornament using the wheel cap clip.

■ **When replacing wheels (vehicles with the tire pressure warning system)**

The wheels of your vehicle are equipped with tire pressure warning valves and transmitters (except for spare tire) that allow the tire pressure warning system to provide advance warning in the event of a loss in tire inflation pressure. Whenever wheels are replaced, tire pressure warning valves and transmitters must be installed. (→P. 432)

⚠ CAUTION

■ **When replacing wheels**

Observe the following precautions to reduce the risk of death or serious injury.

- Do not use wheels that are a different size from those recommended in the Owner's Manual, as this may result in loss of handling control.
- Never use an inner tube in a leaking wheel which is designed for a tubeless tire.

⚠ CAUTION

■ **When installing the wheel nuts**

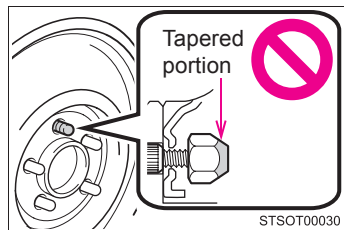

- Be sure to install the wheel nuts with the tapered ends facing inward. Installing the nuts with the tapered ends facing outward can cause the wheel to break and eventually cause the wheel to come off while driving, which could lead to an accident resulting in death or serious injury.

- Never use oil or grease on the wheel bolts or wheel nuts. Oil and grease may cause the wheel nuts to be excessively tightened, leading to bolt or disc wheel damage. In addition, the oil or grease can cause the wheel nuts to loosen and the wheel may fall off, causing an accident and resulting in death or serious injury. Remove any oil or grease from the wheel bolts or wheel nuts.

⚠ NOTICE

■ **Replacing tire pressure warning valves and transmitters (vehicles with the tire pressure warning system)**

- Because tire repair or replacement may affect the tire pressure warning valves and transmitters, make sure to have tires serviced by any authorized Toyota dealer or repairer, or another duly qualified and equipped professional or other qualified service shop. In addition, make sure to purchase your tire pressure warning valves and transmitters at any authorized Toyota dealer or repairer, or another duly qualified and equipped professional.
- Ensure that only genuine Toyota wheels are used on your vehicle. Tire pressure warning valves and transmitters may not work properly with non-genuine wheels.

4-3. Do-it-yourself maintenance

Air conditioning filter

The air conditioning filter must be changed regularly to maintain air conditioning efficiency.

■ Removal method

- STEP 1** Vehicles without smart entry & start system:
Turn the engine switch to the “LOCK” position.
Vehicles with smart entry & start system:
Turn the “ENGINE START STOP” switch off.

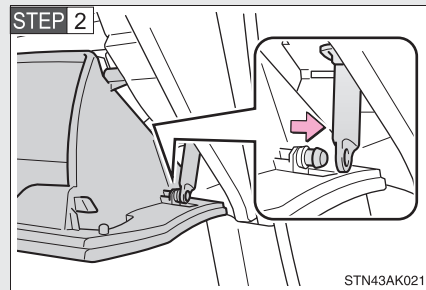

Open the glove box. Slide off the damper.

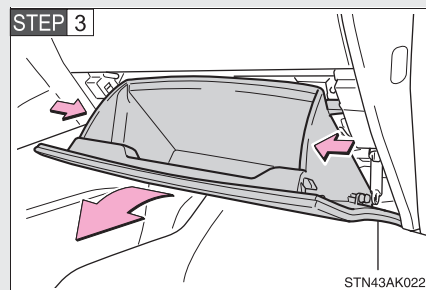

Push in each side of the glove box to disconnect the claws.

STEP 4 Remove the filter cover.

▶ Left-hand drive vehicles

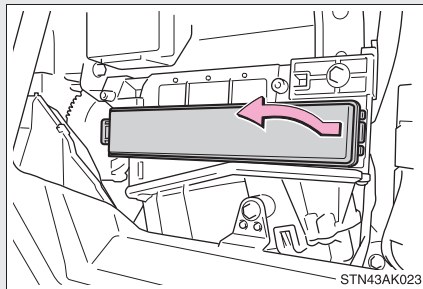

▶ Right-hand drive vehicles

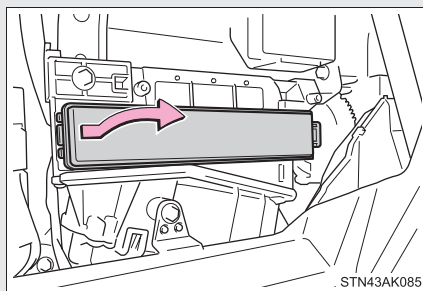

■ Replacement method

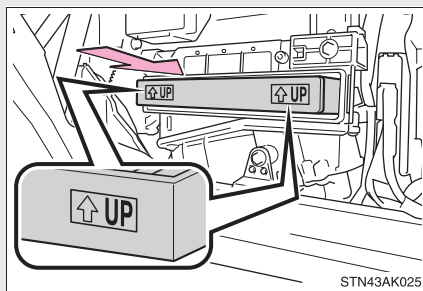

Remove the air conditioning filter and replace it with a new one.

The "↑UP" marks shown on the filter should be pointing up.

■ **Checking interval**

Inspect and replace the air conditioning filter according to the maintenance schedule. In dusty areas or areas with heavy traffic flow, early replacement may be required. (For scheduled maintenance information, please refer to the “Toyota Service Booklet” or “Toyota Warranty Booklet”.)

■ **If air flow from the vents decreases dramatically**

The filter may be clogged. Check the filter and replace if necessary.

 **NOTICE**

■ **When using the air conditioning system**

Make sure that a filter is always installed.
Using the air conditioning system without a filter may cause damage to the system.

4-3. Do-it-yourself maintenance

Key battery

Replace the battery with a new one if it is discharged.

■ You will need the following items:

- Flathead screwdriver (To prevent damage to the key, cover the tip of the screwdriver with rag.)
- Small Phillips-head screwdriver
- Lithium battery
Vehicles without smart entry & start system: CR2016
Vehicles with smart entry & start system: CR1632

■ Replacing the battery (vehicles without smart entry & start system)

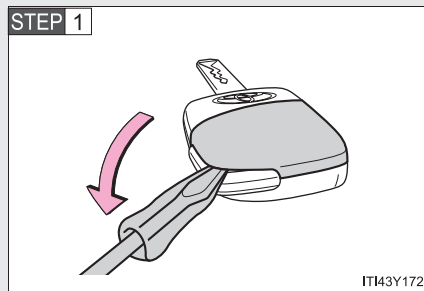

Lift the cover.

Insert the screw driver in the slot and push down.

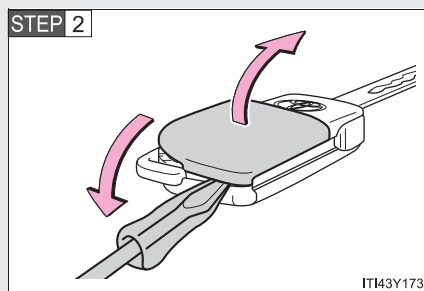

Remove the cover.

Insert the screw driver in the bottom of the key and push down.

4-3. Do-it-yourself maintenance

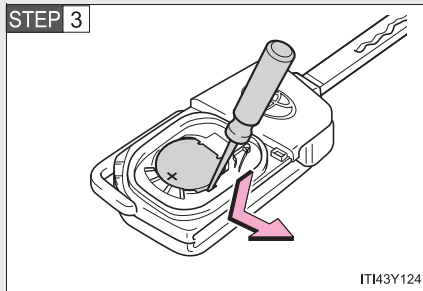

Remove the depleted battery.

Insert a new battery with the "+" terminal facing up.

■ Replacing the battery (vehicles with smart entry & start system)

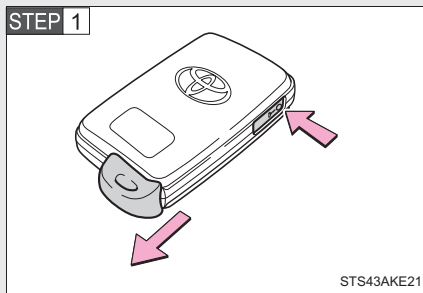

Take out the mechanical key.

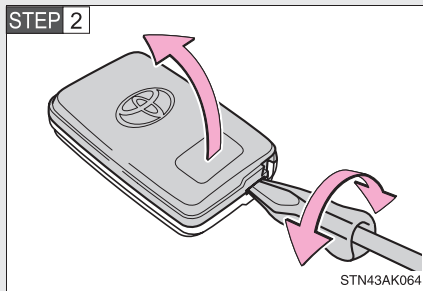

Remove the cover.

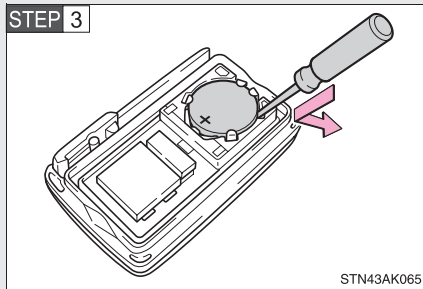

Remove the depleted battery.

Insert a new battery with the "+" terminal facing up.

■ **If the key battery is discharged**

The following symptoms may occur.

- The smart entry & start system (if equipped) and wireless remote control will not function properly.
- The operational range is reduced.

■ **Use the following types of lithium battery**

Vehicles without smart entry & start system: CR2016

Vehicles with smart entry & start system: CR1632

- Batteries can be purchased at any authorized Toyota dealer or repairer, or another duly qualified and equipped professional, jewelers, or camera stores.
- Replace only with the same or equivalent type recommended by any authorized Toyota dealer or repairer, or another duly qualified and equipped professional.
- Dispose of used batteries according to local laws.

 CAUTION

■ **Removed battery and other parts**

These parts are small and if swallowed by a child, they can cause choking. Keep away from children. Failure to do so could result in death or serious injury.

■ **Certification for the key battery**

RISK OF EXPLOSION IF BATTERY IS REPLACED BY AN INCORRECT TYPE. DISPOSE OF USED BATTERIES ACCORDING TO THE INSTRUCTIONS

 NOTICE

■ **For normal operation after replacing the battery**

Observe the following precautions to prevent accidents.

- Always work with dry hands.
Moisture may cause the battery to rust.
- Do not touch or move any other components inside the remote control.
- Do not bend the battery terminals.

4-3. Do-it-yourself maintenance

Checking and replacing fuses

If any of the electrical components do not operate, a fuse may have blown. If this happens, check and replace the fuses as necessary.

STEP 1 Vehicles without smart entry & start system:
Turn the engine switch to the “LOCK” position.
Vehicles with smart entry & start system:
Turn the “ENGINE START STOP” switch off.

STEP 2 The fuses are located in the following places. To check the fuses, follow the instructions below.

■ Engine compartment

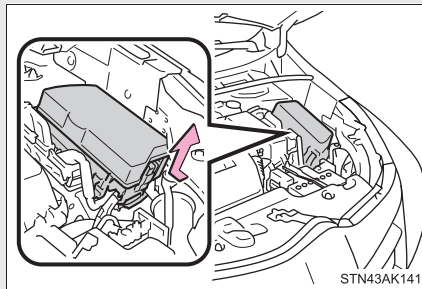

Push the tab in and lift the lid off.

■ Under the driver's side instrument panel (left-hand drive vehicles)

► Type A

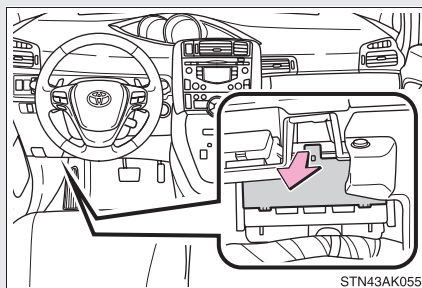

Remove the lid.

4-3. Do-it-yourself maintenance

► Type B

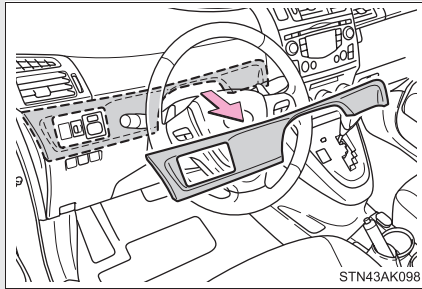

1. Remove the upper instrument panels.

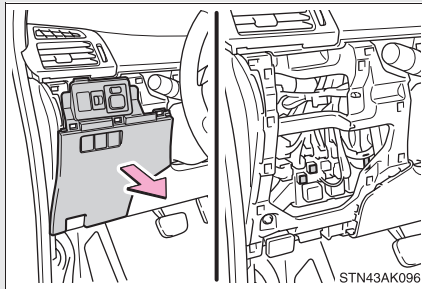

2. Remove the lower instrument panel.

■ Under the passenger's side instrument panel (right-hand drive vehicles)

► Type A

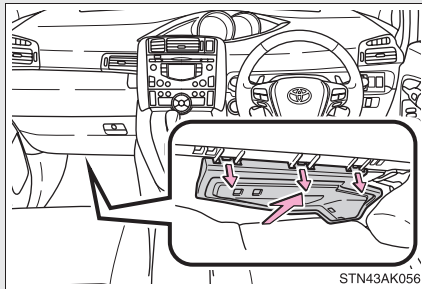

Remove the cover.

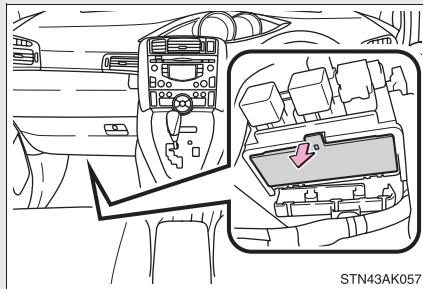

Remove the lid.

► Type B

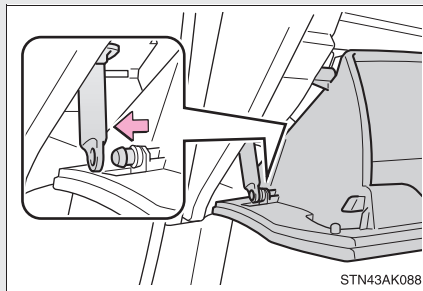

1. Open the glove box. Slide off the damper.

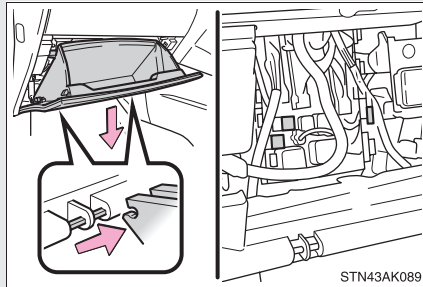

2. Lift the glove box to disconnect the claws at the bottom and remove it.

STEP 3 After a system failure, see “Fuse layout and amperage ratings” (→P. 462) for details about which fuse to check.

4-3. Do-it-yourself maintenance

STEP 4

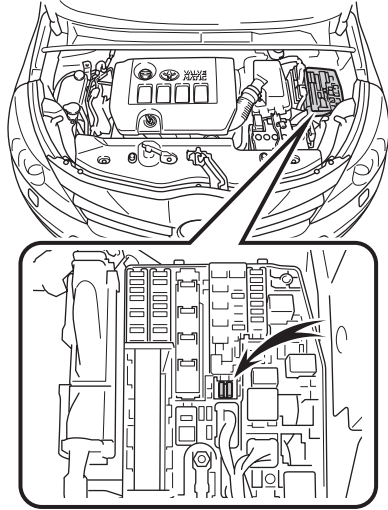

STN43AK112

Remove the fuse with the pull-out tool.

STEP 5 Check if the fuse has blown.

► Type A

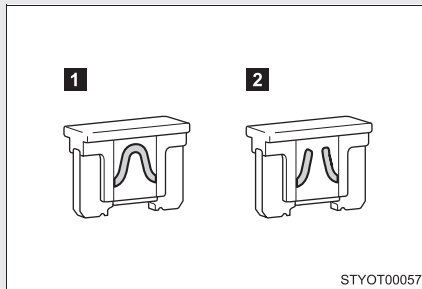

STYOT00057

1 Normal fuse

2 Blown fuse

Replace it with one of an appropriate amperage rating. The amperage rating can be found on the fuse box lid.

► Type B

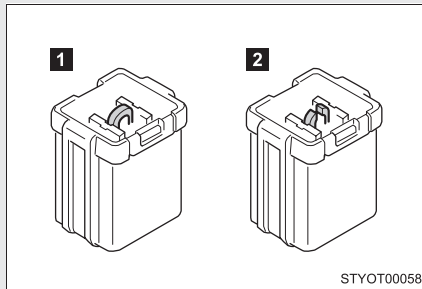

1 Normal fuse

2 Blown fuse

Contact any authorized Toyota dealer or repairer, or another duly qualified and equipped professional.

► Type C

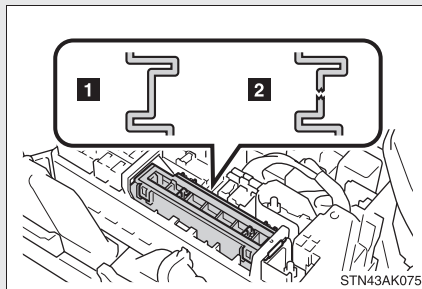

1 Normal fuse

2 Blown fuse

Contact any authorized Toyota dealer or repairer, or another duly qualified and equipped professional.

Fuse layout and amperage ratings

■ Engine compartment

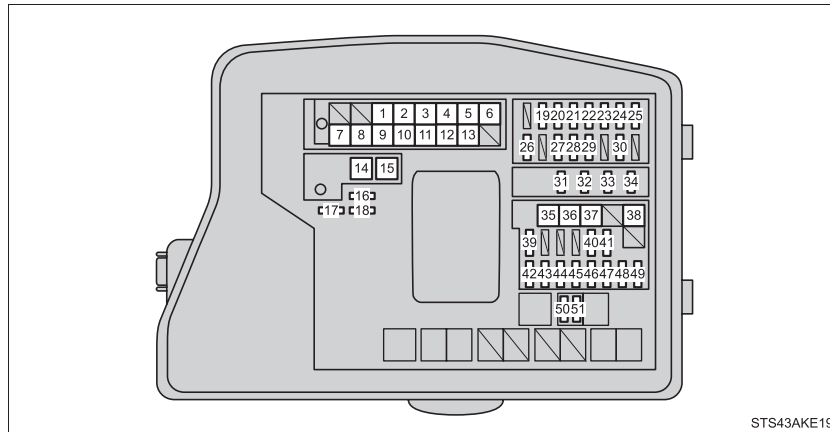

Fuse	Ampere	Circuit
1 TO IP J/B* ¹	120 A	ECU-IG NO.2, HTR-IG, WIPER, RR WIPER, WASHER, ECU-IG NO.1, ECU-IG NO.3, SEAT HTR, AM1* ³ , DOOR, STOP, FR DOOR, POWER, RR DOOR, RL DOOR, OBD, ACC-B, RR FOG, FR FOG, DEF, TAIL, SUNROOF, DRL
2 H-LP CLN	30 A	Headlight cleaners
3 RDI FAN	40 A	Electric cooling fan(s)
4 CDS FAN* ¹	30 A	Electric cooling fan(s)
5 ABS NO.1	50 A	Anti-lock brake system, VSC+
6 HTR* ²	50 A	Air conditioning system

	Fuse	Ampere	Circuit
7	ALT*2	120 A	Charging system, RDI FAN, CDS FAN, H-LP CLN, ABS NO.1, ABS NO.2, HTR, PWR OUTLET, HTR SUB NO.1, HTR SUB NO.2, HTR SUB NO.3, ECU-IG NO.2, HTR-IG, WIPER, RR WIPER, WASHER, ECU-IG NO.1, ECU-IG NO.3, SEAT HTR, AM1*3, DOOR, STOP, FR DOOR, POWER, RR DOOR, RL DOOR, OBD, ACC-B, RR FOG, FR FOG, DEF, TAIL, SUNROOF, DRL
8	EPS*2	80 A	Electric power steering
	GLOW*1	80 A	Engine glow system
9	EPS*1	80 A	Electric power steering
10	P-SYSTEM*2	30 A	VALVEMATIC system
11	FUEL HTR*1	50 A	Fuel heater
12	P/I*2	50 A	EFI MAIN*2, IGT/INJ*2, HORN, IG2
	H-LP MAIN*1	50 A	H-LP LH LO, H-LP RH LO, H-LP LH HI, H-LP RH HI
13	P/I*1	50 A	HORN, IG2, ELEC FUEL PMP
	H-LP MAIN*2	50 A	H-LP LH LO, H-LP RH LO, H-LP LH HI, H-LP RH HI
14	BBC*1	40 A	Stop & Start system
15	EFI MAIN*1	50 A	EFI NO.1, EFI NO.2, EFI NO.4

4-3. Do-it-yourself maintenance

	Fuse	Ampere	Circuit
16	SPARE	10 A	Spare fuse
17	SPARE	30 A	Spare fuse
18	SPARE	20 A	Spare fuse
19	DOOR NO.2	25 A	Main body ECU
20	EFI MAIN NO.2*1	7.5 A	Multiport fuel injection system/ sequential multiport fuel injection system
21	ECU-B2	10 A	Smart entry & start system, air conditioning system, power windows
22	D.C.C	SHORT	No circuit
23	ECU-B	10 A	Gauges and meters, main body ECU, steering sensor, double locking system, wireless remote control, smart entry & start system
24	RAD NO.1*2	20 A	Audio system
25	DOME	10 A	Luggage compartment light, vanity lights, front door courtesy lights, personal/interior lights, foot lights
26	AM2 NO.2	7.5 A	Starting system
27	TURN-HAZ	10 A	Turn signal lights, emergency flashers
28	ETCS*2	10 A	Electronic throttle control system
29	AM2	30 A	Starting system
30	STRG LOCK	20 A	Steering lock system
31	IGT/INJ*2	15 A	Multiport fuel injection system/ sequential multiport fuel injection system

	Fuse	Ampere	Circuit
32	EFI MAIN* ²	20 A	Multiport fuel injection system/ sequential multiport fuel injection system, EFI NO.1, EFI NO.2
	FUEL PUMP* ¹	30 A	Fuel pump
33	HORN	15 A	Horn
34	IG2	15 A	IGN, METER
35	HTR SUB NO.1	50 A* ¹	Air conditioning system
		30 A* ²	
36	HTR* ¹	50 A	Air conditioning system
37	HTR SUB NO.2	30 A	Air conditioning system
38	HTR SUB NO.3	30 A	Air conditioning system
39	PWR OUTLET	15 A	Power outlet
40	ABS NO.2	30 A	Anti-lock brake system, VSC+
41	STV HTR* ¹	25 A	Power heater
42	EFI NO.4* ¹	20 A	Multiport fuel injection system/ sequential multiport fuel injection system
43	IG2 NO.2* ²	7.5 A	Starting system
44	EFI NO.2	15 A* ¹	Multiport fuel injection system/ sequential multiport fuel injection system, Stop & Start system
		10 A* ²	Multiport fuel injection system/ sequential multiport fuel injection system

4-3. Do-it-yourself maintenance

Fuse		Ampere	Circuit
45	EFI NO.1	7.5 A ^{*1}	Multipoint fuel injection system/ sequential multipoint fuel injection system
		10 A ^{*2}	Multipoint fuel injection system/ sequential multipoint fuel injection system
46	H-LP RH HI	10 A	Right-hand headlight (high beam) ^{*4} , right-hand headlight solenoid ^{*5}
47	H-LP LH HI	10 A	Left-hand headlight (high beam) ^{*4} , left-hand headlight solenoid ^{*5}
48	H-LP RH LO	10 A ^{*4}	Right-hand headlight (low beam)
		15 A ^{*5}	Right-hand discharge headlight (low and high beam)
49	H-LP LH LO	10 A ^{*4}	Left-hand headlight (low beam)
		15 A ^{*5}	Left-hand discharge headlight (low and high beam)
50	RDI EFI ^{*1}	5 A	Electric cooling fan(s)
51	CDS EFI ^{*1}	5 A	Electric cooling fan(s)

- *1: Vehicles with diesel engine
- *2: Vehicles with gasoline engine
- *3: Vehicles without smart entry & start system
- *4: Vehicles with halogen headlights
- *5: Vehicles with discharge headlights

■ Under the instrument panel (type A)

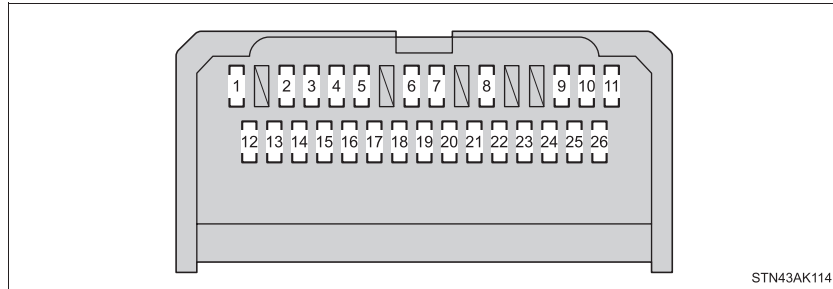

Fuse		Ampere	Circuit
1	TAIL	10 A	Front position lights, tail lights, license plate lights, rear fog light, front fog lights, manual headlight leveling system, instrument cluster lights, glove box light, switch illumination, Toyota parking assist-sensor ECU
2	ECU-IG NO.3	10 A	Panoramic roof shade, auto anti-glare inside rear view mirror, smart entry & start system, audio system, Stop & Start system*2
3	FR DOOR	20 A	Power windows (front passenger side)
4	RL DOOR	20 A	Power windows (rear left)
5	RR DOOR	20 A	Power windows (rear right)
6	CIG	15 A	Power outlets
7	ACC	7.5 A	Shift lock system, audio system, main body ECU, power outlet, outside rear view mirrors, Stop & Start system*2
8	MIR HTR	10 A	Outside rear view mirror defoggers
9	RR FOG	7.5 A	Rear fog light

4-3. Do-it-yourself maintenance

Fuse		Ampere	Circuit
10	IGN	7.5 A	Steering lock system, SRS airbag system, multiport fuel injection system/sequential multiport fuel injection system, starting system
11	METER	7.5 A	Gauges and meters, Stop & Start system* ²
12	SEAT HTR	15 A	Seat heaters
13	HTR-IG	10 A	Air conditioning system, power heater
14	WIPER	25 A	Windshield wipers, rain-sensing windshield wipers
15	RR WIPER	15 A	Rear window wiper
16	WASHER	15 A	Windshield washers, rear window washer
17	ECU-IG NO.1	10 A	Main body ECU* ³ , electric cooling fan(s), shift lock system, anti-lock brake system, steering sensor, yaw rate sensor, VSC+, headlight cleaners, SEQUENTIAL switch, automatic headlight leveling system, electric power steering, tire pressure warning system
18	ECU-IG NO.2	10 A	Back-up light, charging system* ³ , emergency flashers, rear window defogger, "PASSENGER AIRBAG" indicator, air conditioning system, Toyota parking assist-sensor indicator, Toyota parking assist-sensor switch

	Fuse	Ampere	Circuit
19	OBD	7.5 A	On-board diagnosis system
20	STOP	10 A	Stop lights, high mounted stop-light, anti-lock brake system, VSC+, shift lock system, starting system
21	SUNROOF	20 A	Panoramic roof shade
22	DOOR	25 A	Power door lock system
23	ACC-B	25 A	CIG, ACC
24	DRL	7.5 A	Daytime running lights
25	FR FOG	7.5 A	Front fog lights
26	AM1*1	7.5 A	Starting system

*1: Vehicles without smart entry & start system

*2: Vehicles with diesel engine

*3: Vehicles with gasoline engine

■ Under the instrument panel (type B)

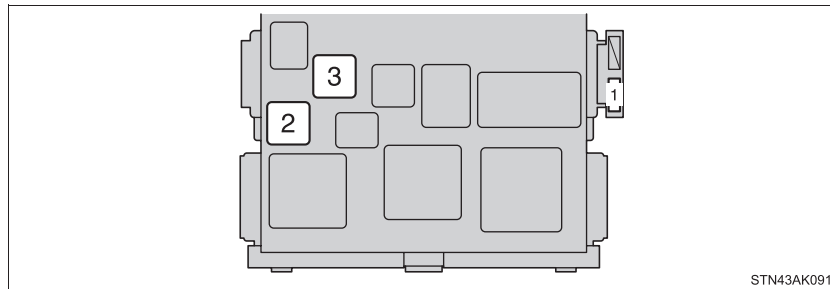

	Fuse	Ampere	Circuit
1	WIPER NO.2	7.5 A	Charging system
2	POWER	30 A	Power windows (driver side)
3	DEF	30 A	Rear window defogger, MIR HTR

■ After a fuse is replaced

- If the lights do not turn on even after the fuse has been replaced, a bulb may need replacement. (→P. 472)
- If the replaced fuse blows again, have the vehicle inspected by any authorized Toyota dealer or repairer, or another duly qualified and equipped professional.

■ If there is an overload in the circuits

The fuses are designed to blow, protecting the wiring harness from damage.

■ When replacing light bulbs

Toyota recommends that you use genuine Toyota products designed for this vehicle. Because certain bulbs are connected to circuits designed to prevent overload, non-genuine parts or parts not designed for this vehicle may be unusable.

 CAUTION

■ **To prevent system breakdowns and vehicle fire**

Observe the following precautions.

Failing to do so may cause damage to the vehicle, and possibly a fire or injury.

- Never use a fuse of a higher amperage rating than indicated, or use any other object in place of a fuse.
- Always use a genuine Toyota fuse or equivalent.
Never replace a fuse with a wire, even as a temporary fix.
- Do not modify the fuse or the fuse box.

 NOTICE

■ **Before replacing fuses**

Have the cause of electrical overload determined and repaired by any authorized Toyota dealer or repairer, or another duly qualified and equipped professional, as soon as possible.

4-3. Do-it-yourself maintenance

Light bulbs

You may replace the following bulbs yourself. The difficulty level of replacement varies depending on the bulb. If necessary bulb replacement seems difficult to perform, contact any authorized Toyota dealer or repairer, or another duly qualified and equipped professional.

For more information about replacing other light bulbs, contact any authorized Toyota dealer or repairer, or another duly qualified and equipped professional.

■ Prepare a replacement light bulb

Check the wattage of the light bulb being replaced. (→P. 598)

■ Remove the engine compartment cover

→P. 416

■ Front bulb locations

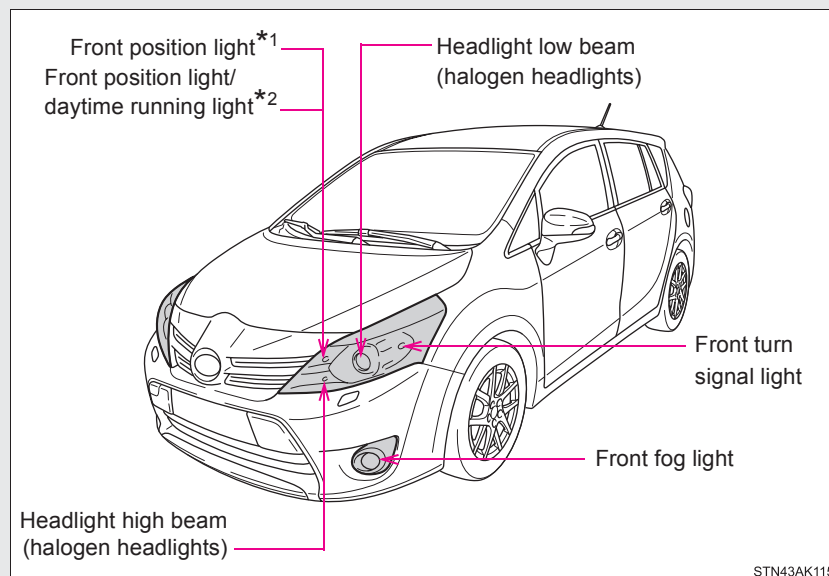

*1: Halogen headlights without daytime running light system

*2: Halogen headlights with daytime running light system

■ Rear bulb locations

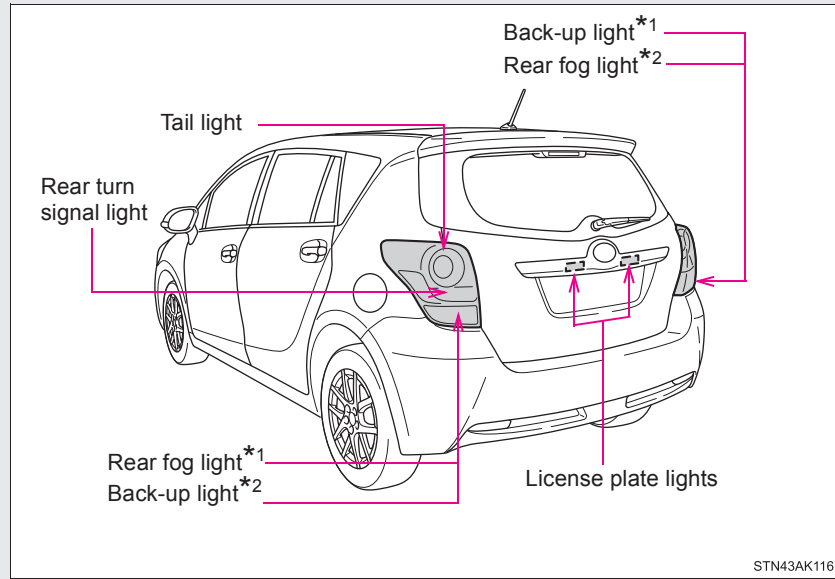

*1: Left-hand drive vehicles
*2: Right-hand drive vehicles

Replacing light bulbs

■ **Before replacing the following bulbs:**

- Headlight (halogen headlights)
- Front position light (halogen headlights without daytime running light system)
- Front position light/daytime running light (halogen headlights with daytime running light system)
- Front turn signal light

STEP 1 Removing the engine compartment cover. (→P. 416)

STEP 2 Removing the air cleaner duct and/or moving the washer fluid filler opening.

► Left side

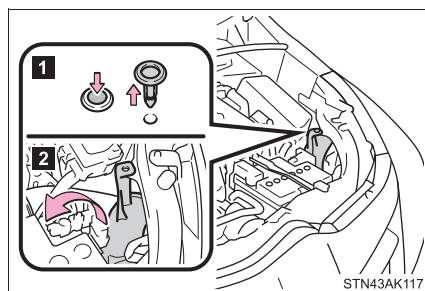

Remove the upper of the air cleaner duct.

- 1** Remove the securing clip.
- 2** Remove the upper of the air cleaner duct to allow easy access to light bulbs.

After replacing the bulbs, make sure to firmly install the upper portion of the air cleaner duct and secure it with the clip.

► Right side

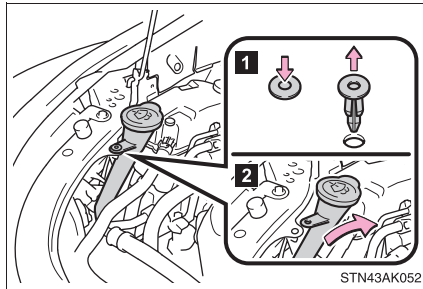

Move the washer fluid filler opening.

- 1 Remove the securing clip.
- 2 Move the washer fluid filler opening.

After replacing the bulbs, make sure to firmly install the washer fluid filler opening and secure it with the clip.

■ Headlight low beam (halogen headlights)

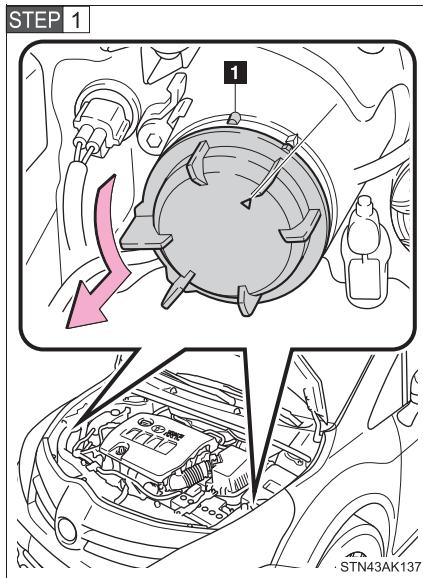

Turn the cover to the open position and remove it.

- 1 Open position

4-3. Do-it-yourself maintenance

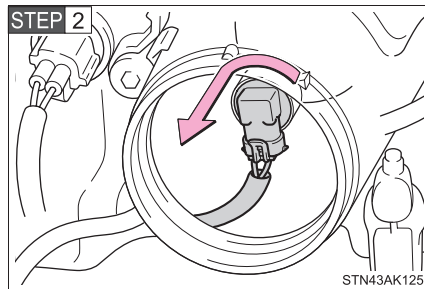

Turn the bulb base counterclockwise.

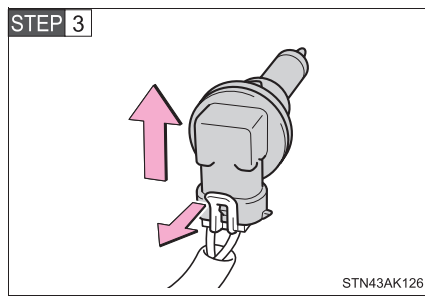

Unplug the connector while pulling the lock release.

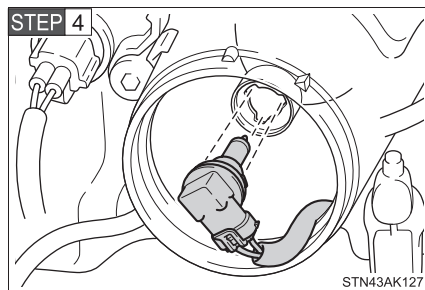

Replace the light bulb, and install the bulb base.

Align the 3 tabs on the light bulb with the mounting, and insert.

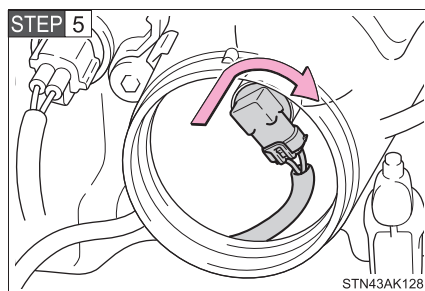

Turn and secure the bulb base.

Shake the bulb base gently to check that it is not loose, turn the headlight low beam on once and visually confirm that no light is leaking through the mounting.

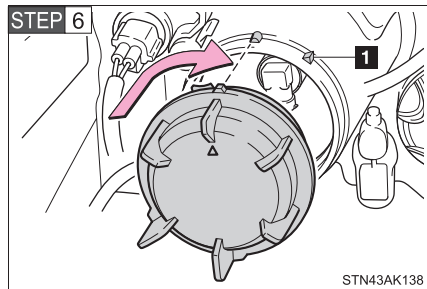

Install and turn the cover to the closed position.

1 Closed position

STEP 7 After replacing the light bulb, replace the air cleaner duct and/or washer fluid filler opening by conducting **STEP 1**. (→P. 485)

■ **Headlight high beam (halogen headlights)**

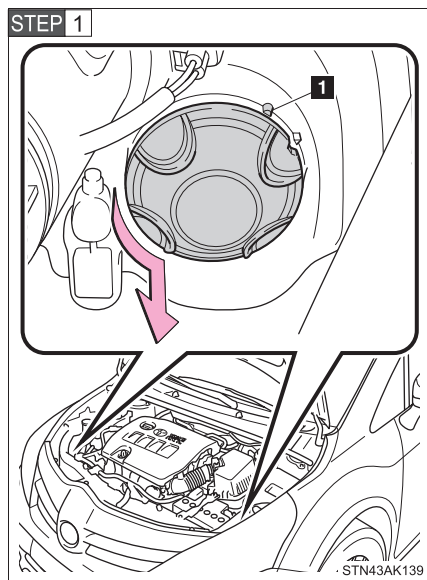

Turn the cover to the open position and remove it.

1 Open position

4-3. Do-it-yourself maintenance

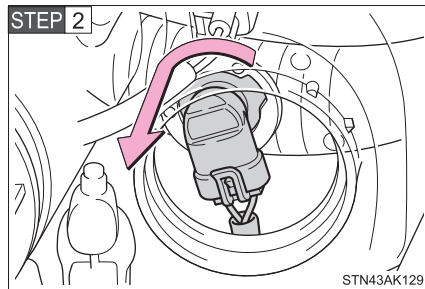

Turn the bulb base counterclockwise.

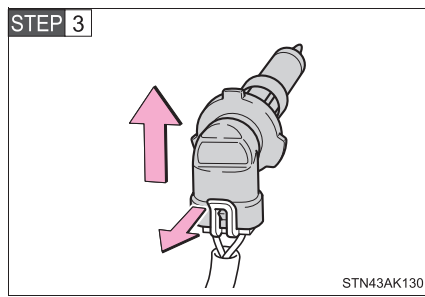

Unplug the connector while pulling the lock release.

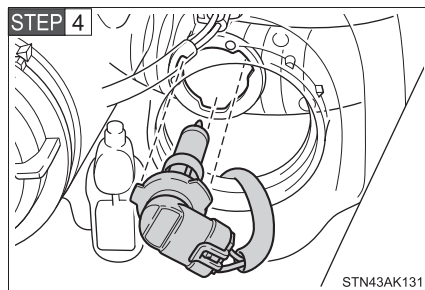

Replace the light bulb, and install the bulb base.

Align the 3 tabs on the light bulb with the mounting, and insert.

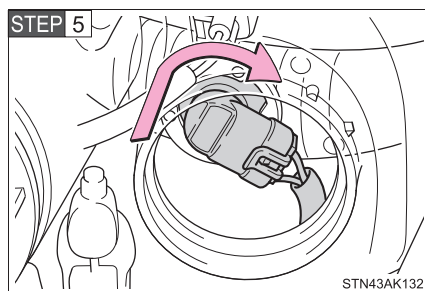

Turn and secure the bulb base.

Shake the bulb base gently to check that it is not loose, turn the headlight high beam on once and visually confirm that no light is leaking through the mounting.

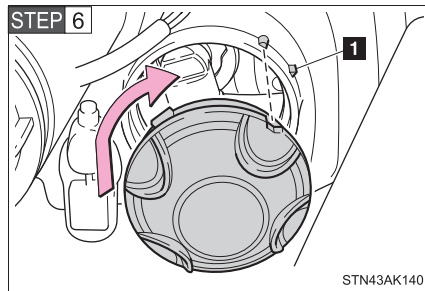

Install and turn the cover to the closed position.

1 Closed position

STEP 7 After replacing the light bulb, replace the air cleaner duct and/or washer fluid filler opening by conducting **STEP 1**. (→P. 485)

■ Front fog light

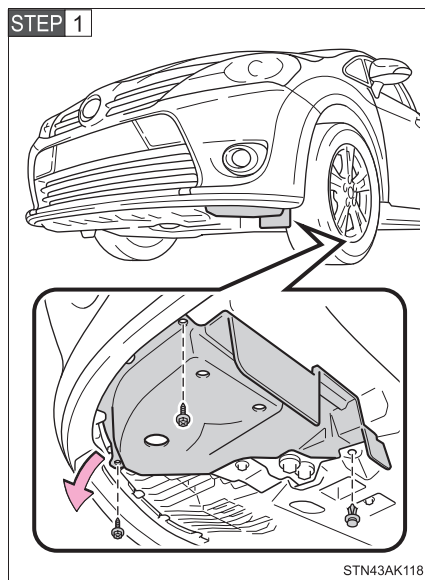

Remove the fender liner bolts and clip, and then partly remove the fender liner.

4-3. Do-it-yourself maintenance

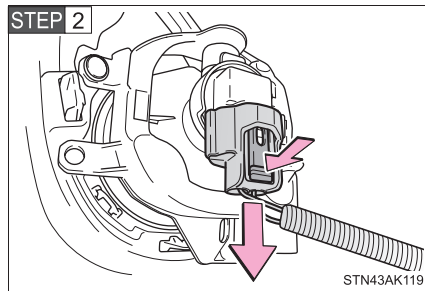

Unplug the connector while depressing the lock release.

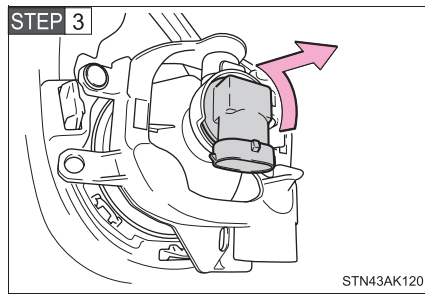

Turn the bulb base counterclockwise.

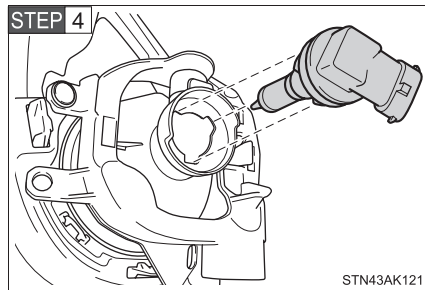

Replace the light bulb, and install the bulb base.

Align the 3 tabs on the light bulb with the mounting, and insert.

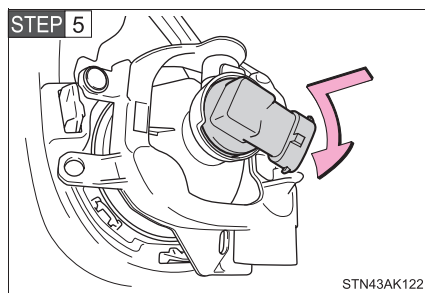

Turn and secure the bulb base.

Shake the bulb base gently to check that it is not loose, turn the front fog light on once and visually confirm that no light is leaking through the mounting.

STEP 6 When installing the fender liner, install by conducting **STEP 1** with the directions reversed.

■ **Front position light (halogen headlights without daytime running light system), front position light/daytime running light (halogen headlights with daytime running light system)**

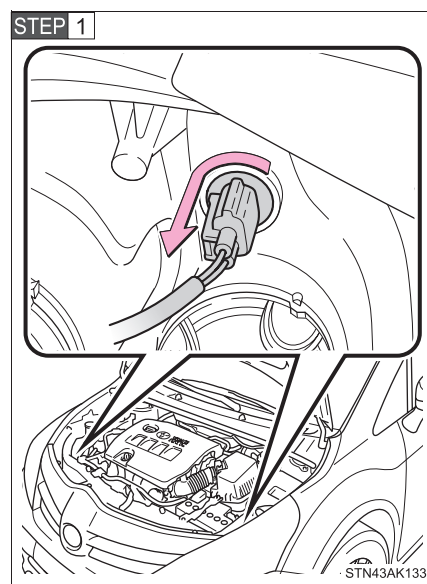

Turn the bulb base counterclockwise.

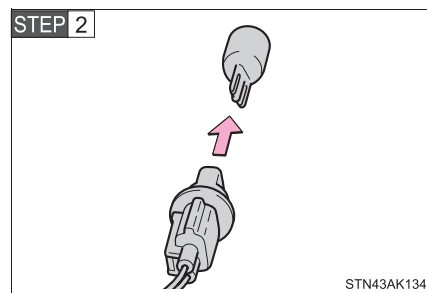

Remove the light bulb.

■ Front turn signal light

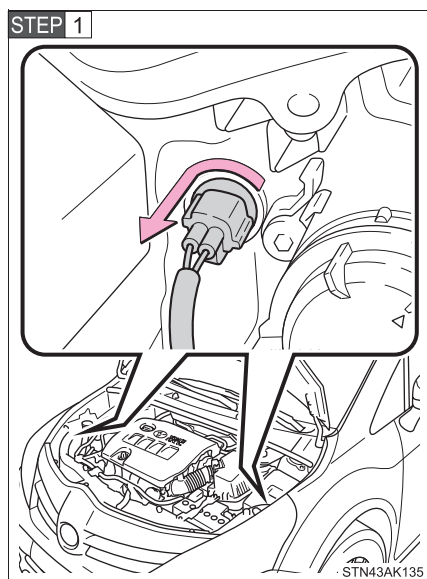

Turn the bulb base counterclockwise.

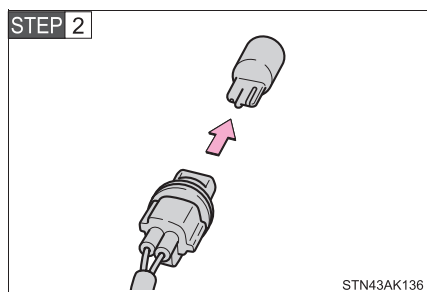

Remove the light bulb.

■ Back-up light/rear fog light, tail light and rear turn signal light

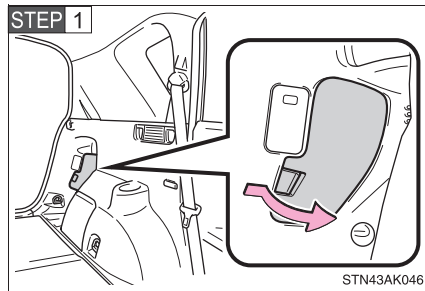

Open the back door and remove the cover.

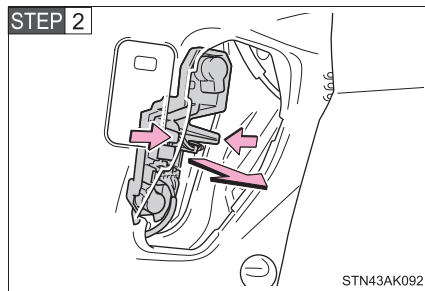

Disengage the 2 claws and remove the rear combination light socket.

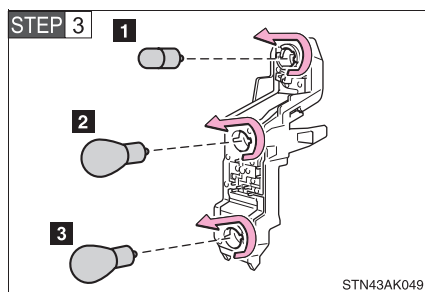

Remove the light bulb.

- 1 Tail light
- 2 Rear turn signal light
- 3 Back-up light or rear fog light

■ License plate light

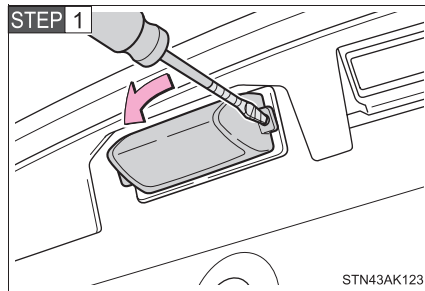

Remove the cover.

Insert a properly sized screwdriver into the hole of the cover, and pry off the cover as shown in the illustration.

To prevent damaging the vehicle, wrap the screwdriver with a tape.

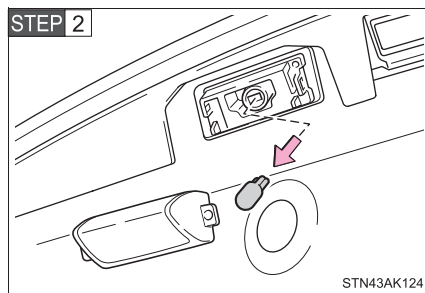

Remove the light bulb.

■ Lights other than the above

If any of the lights listed below has burnt out, have it replaced by any authorized Toyota dealer or repairer, or another duly qualified and equipped professional.

- Headlights (discharge headlights)
- Front position lights/daytime running lights (discharge headlights)
- Side turn signal lights
- High mounted stoplight
- Stop lights

■ **When replacing the following bulbs:**

- Headlight (halogen headlights)
- Front position light (halogen headlights without daytime running light system)
- Front position light/daytime running light (halogen headlights with daytime running light system)
- Front turn signal light

STEP 1 Replacing the air cleaner duct and/or washer fluid filler opening.

▶ Left side

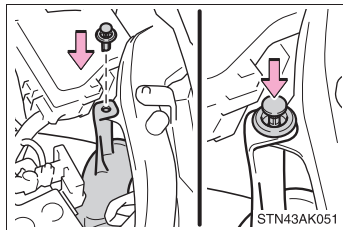

After replacing the bulbs, make sure to secure the upper part of the air cleaner duct with the clip.

▶ Right side

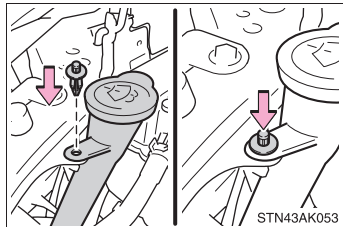

After replacing the bulbs, make sure to secure the washer fluid filler opening with the clip.

STEP 2 Replacing the engine compartment cover. (→P. 416)

■ **Condensation build-up on the inside of the lens**

Temporary condensation build-up on the inside of the headlight lens does not indicate a malfunction.

Contact any authorized Toyota dealer or repairer, or another duly qualified and equipped professional, for more information in the following situations:

- Large drops of water are built up on the inside of the lens.
- Water has built up inside the headlight.

■ **Discharge headlights (if equipped)**

If voltage to the discharge bulbs is insufficient, the bulbs may not come on, or may go out temporarily. The discharge bulbs will come on when normal power is restored.

■ **LED light bulbs**

The front position lights/daytime running lights (discharge headlights), stop lights and high mounted stoplight consist of a number of LEDs. If any of the LEDs burn out, take your vehicle to any authorized Toyota dealer or repairer, or another duly qualified and equipped professional to have the light replaced.

If two or more LEDs in a stop light burn out, your vehicle may not conform to local laws (ECE).

■ **When replacing light bulbs**

→P. 470

⚠ CAUTION**■ Replacing light bulbs**

- Turn off the lights. Do not attempt to replace the bulb immediately after turning off the lights.
The bulbs become very hot and may cause burns.
- Do not touch the glass portion of the light bulb with bare hands.
When it is unavoidable to hold the glass portion, use and hold with a clean dry cloth to avoid getting moisture and oils on the bulb.
Also, if the bulb is scratched or dropped, it may blow out or crack.
- Fully install light bulbs and any parts used to secure them. Failing to do so may result in heat damage, fire, or water entering the headlight unit. This may damage the headlights or cause condensation to build up on the lens.

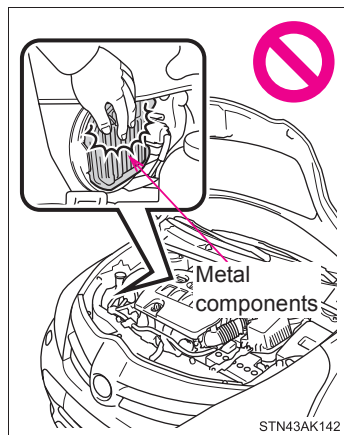

- Vehicles with discharge headlights:
While the headlights are turned on, and for a short time after they have been turned off, metal components at the rear of the headlight assembly will be extremely hot. To prevent burns, do not touch these metal components until you are certain they have cooled down.

 CAUTION

■ **Discharge headlights (if equipped)**

- Contact any authorized Toyota dealer or repairer, or another duly qualified and equipped professional, before replacing the discharge headlights (including light bulbs).
- Do not touch the high-intensity discharge headlight's high voltage socket when the headlights are turned on.
An extremely high voltage of 30000 V will be discharged and could result in serious injury or death by electric shock.
- Do not attempt to repair or disassemble light bulbs, connectors, electric circuits or component parts.
Doing so may result in death or serious injury due to electric shock.

■ **To prevent damage or fire**

Make sure bulbs are fully seated and locked.

5-1. Essential information

- Emergency flashers 490
- If your vehicle needs to be towed 491
- If you think something is wrong 498
- Fuel pump shut off system (gasoline engine) 499

5-2. Steps to take in an emergency

- If a warning light turns on or a warning buzzer sounds... 500
- If a warning message is displayed 509
- If you have a flat tire (vehicles with spare tire) 522
- If you have a flat tire (vehicles with emergency tire puncture repair kit).... 539
- If the engine will not start..... 556
- If the shift lever cannot be shifted from "P" (vehicles with a Multidrive)..... 559
- If you lose your keys 560
- If you cannot operate the back door opener..... 561
- If the electronic key does not operate properly (vehicles with smart entry & start system)..... 562
- If the vehicle battery is discharged 565
- If your vehicle overheats... 569
- If the vehicle becomes stuck 572
- If your vehicle has to be stopped in an emergency 574

5-1. Essential information

Emergency flashers

The emergency flashers are used to warn other drivers when the vehicle has to be stopped in the road due to a breakdown, etc.

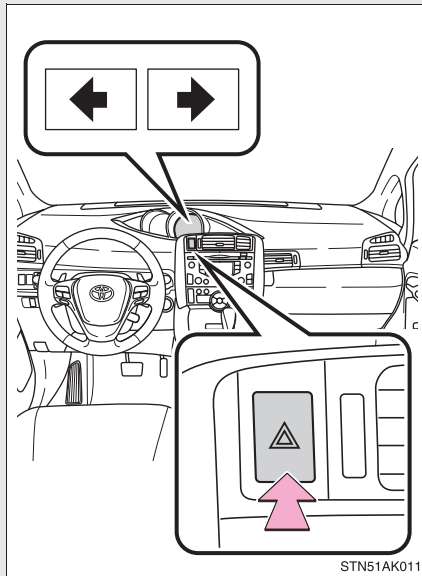

Press the switch.

All the turn signal lights will flash.

To turn them off, press the switch once again.

■ Emergency flashers

If the emergency flashers are used for a long time while the engine is not operating, the battery may discharge.

5-1. Essential information

If your vehicle needs to be towed

If towing is necessary, we recommend having your vehicle towed by any authorized Toyota dealer or repairer, or another duly qualified and equipped professional, such as a commercial towing service, using a lift-type truck or a flatbed truck.

Use a safety chain system for all towing, and abide by all state/provincial and local laws.

Situations needs to contact dealers before towing

The following may indicate a problem with your transmission. Contact any authorized Toyota dealer or repairer, or another duly qualified and equipped professional or commercial towing service before towing.

- The engine is running, but the vehicle will not move.
- The vehicle makes an abnormal sound.

Towing with a sling-type truck

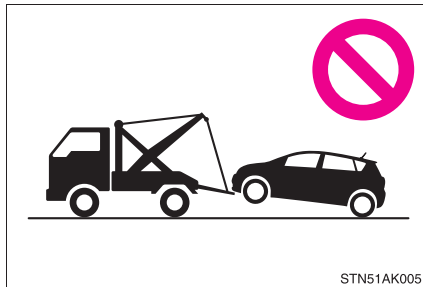

Do not tow with a sling-type truck to prevent body damage.

Towing with a wheel-lift type truck

From the front

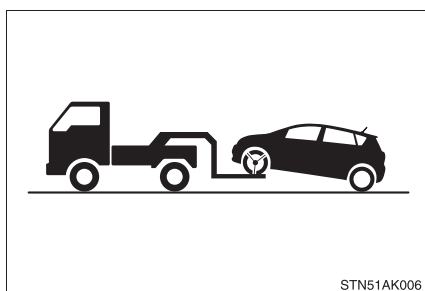

Release the parking brake.

From the rear

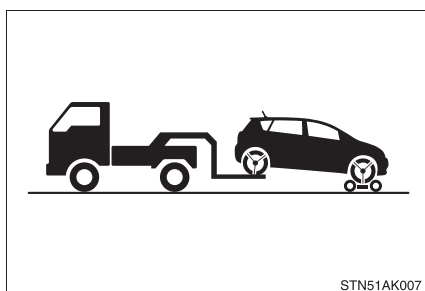

Use a towing dolly under the front wheels.

Using a flatbed truck

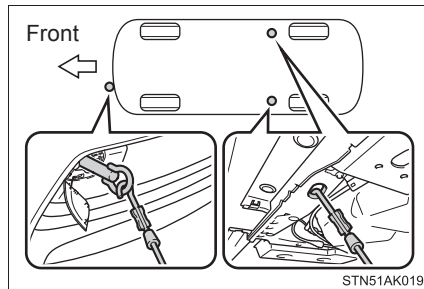

If your Toyota is transported by a flatbed truck, it should be tied down at the locations shown in the illustration.

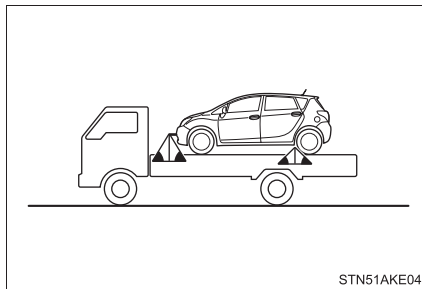

If you use chains or cables to tie down your vehicle, the angles shaded in black must be 45°.

Do not overly tighten the tie downs or the vehicle may be damaged.

Emergency towing

If a tow truck is not available in an emergency, your vehicle may be temporarily towed using a cable or chain secured to the emergency towing eyelet. This should only be attempted on hard surfaced roads for 80 km (50 miles) at low speeds.

A driver must be in the vehicle to steer and operate the brakes. The vehicle's wheels, drive train, axles, steering and brakes must be in good condition.

Emergency towing procedure

STEP 1 Take out the towing eyelet. (→P. 522, 539)

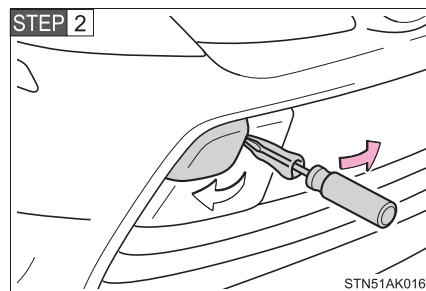

Remove the eyelet cover using a flathead screwdriver.

To protect the bodywork, place a rag between the screwdriver and the vehicle body, as shown in the illustration.

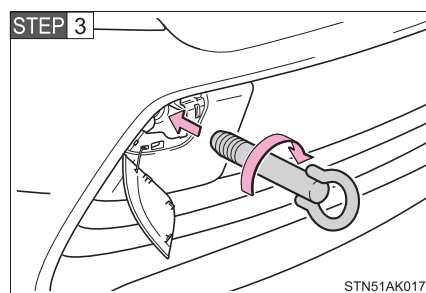

Insert the towing eyelet into the hole and tighten partially by hand.

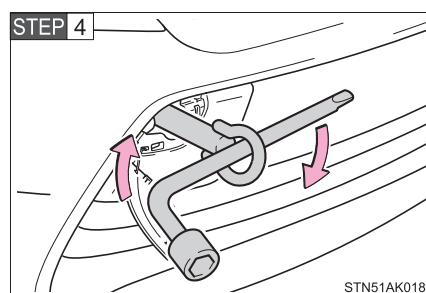

Tighten down the towing eyelet securely using a wheel nut wrench or hard metal bar.

STEP 5 Securely attach a cable or chain to the towing eyelet.
Take care not to damage the vehicle body.

STEP 6 Vehicles without a smart entry & start system: Enter the vehicle being towed and start the engine.

If the engine does not start, turn the engine switch to the "ON" position.

Vehicles with a smart entry & start system: Enter the vehicle being towed and start the engine.

If the engine does not start, turn the "ENGINE START STOP" switch to IGNITION ON mode.

STEP 7 Shift the shift lever to N and release the parking brake.

Vehicles with a Multidrive: When the shift lever cannot be shifted. (→P. 559)

■ **While towing**

If the engine is not running, the power assist for the brakes and steering will not function, making steering and braking more difficult.

■ **Wheel nut wrench**

Wheel nut wrench is installed in luggage compartment. (→P. 522, 539)

⚠ CAUTION

Observe the following precautions.
Failure to do so may result in death or serious injury.

■ **When towing the vehicle**

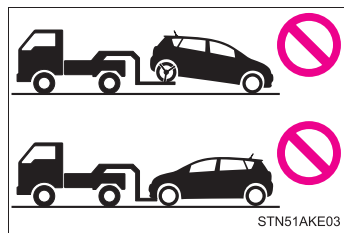

Be sure to transport the vehicle with the front wheels raised or with all four wheels raised off the ground. If the vehicle is towed with the front wheels contacting the ground, the drivetrain and related parts may be damaged.

■ **While towing**

- When towing using a cables or chains, avoid sudden starts, etc. which place excessive stress on the towing eyelets, cables or chains. The towing eyelets, cables or chains may become damaged, broken debris may hit people and cause serious damage.
- Do not turn the engine switch to the “LOCK” position (vehicles without a smart entry & start system) or the “ENGINE START STOP” switch off (vehicles with a smart entry & start system).
There is a possibility that the steering wheel is locked and cannot be operated.

■ **Installing towing eyelet to the vehicle**

Make sure that towing eyelet is installed securely.
If not securely installed, towing eyelet may come loose during towing.

 NOTICE

■ **To prevent damage to the vehicle when towing using a wheel-lift type truck**

When raising the vehicle, ensure adequate ground clearance for towing at the opposite end of the raised vehicle. Without adequate clearance, the vehicle could be damaged while being towed.

■ **To prevent body damage when towing with a sling-type truck**

Do not tow with a sling-type truck, either from the front or rear.

5-1. Essential information

If you think something is wrong

If you notice any of the following symptoms, your vehicle probably needs adjustment or repair. Contact any authorized Toyota dealer or repairer, or another duly qualified and equipped professional, as soon as possible.

■ Visible symptoms

- Fluid leaks under the vehicle
(Water dripping from the air conditioning after use is normal.)
- Flat-looking tires or uneven tire wear
- High engine coolant temperature warning light flashes or comes on
- Low engine coolant temperature indicator comes on or does not come on continuously

■ Audible symptoms

- Changes in exhaust sound
- Excessive tire squeal when cornering
- Strange noises related to the suspension system
- Pinging or other noises related to the engine

■ Operational symptoms

- Engine misfire, stumbling or running rough
- Appreciable loss of power
- Vehicle pulls heavily to one side when braking
- Vehicle pulls heavily to one side when driving on a level road
- Loss of brake effectiveness, spongy feeling, pedal almost touches the floor

5-1. Essential information

Fuel pump shut off system (gasoline engine)

To minimize the risk of fuel leakage when the engine stalls or an airbag inflates upon collision, the fuel pump shut off system stops supplying fuel to the engine.

Follow the procedure below to restart the engine after the system is activated.

STEP 1 Vehicles without smart entry & start system:

Turn the engine switch to the “ACC” or “LOCK” position.

Vehicles with smart entry & start system:

Turn the “ENGINE START STOP” switch to ACCESSORY mode or off.

STEP 2 Restart the engine.



NOTICE

■ **Before starting the engine**

Inspect the ground under the vehicle.

If you find that fuel has leaked onto the ground, the fuel system has been damaged and is in need of repair. Do not restart the engine.

5-2. Steps to take in an emergency

If a warning light turns on or a warning buzzer sounds...

Calmly perform the following actions if any of the warning lights turn on or flash. If a light turns on or flashes, but then turns off, this does not necessarily indicate a malfunction in the system.

Stop the vehicle immediately. Continuing to drive the vehicle may be dangerous.



The following warning indicates a possible problem in the brake system. Immediately stop the vehicle in a safe place and contact any authorized Toyota dealer or repairer, or another duly qualified and equipped professional.

Warning light	Warning light/Details
	<p>Brake system warning light (warning buzzer)*</p> <ul style="list-style-type: none"> • Low brake fluid • Malfunction in the brake system <p>This light also comes on when the parking brake is not released. If the light turns off after the parking brake is fully released the system is operating normally.</p>

*: Parking brake engaged warning buzzer: (→P. 512)







Stop the vehicle immediately.

The following warnings indicate the possibility of damage to the vehicle that may lead to an accident. Immediately stop the vehicle in a safe place and contact any authorized Toyota dealer or repairer, or another duly qualified and equipped professional.

Warning light	Warning light/Details
	<p>Charging system warning light</p> <p>Indicates a malfunction in the vehicle's charging system.</p>
 (Red warning light flashes or comes on)	<p>High engine coolant temperature warning light</p> <p>Indicates that the engine is overheating.</p> <p>As the coolant temperature rises, it changes from flashing to comes on. (→P. 569)</p>

Have the vehicle inspected immediately.

Failing to investigate the cause of the following warnings may lead to the system operating abnormally and possibly cause an accident. Have the vehicle inspected by any authorized Toyota dealer or repairer, or another duly qualified and equipped professional, immediately.

Warning light	Warning light/Details
	Malfunction indicator lamp Indicates a malfunction in: <ul style="list-style-type: none"> • The emission control system; • The electronic engine control system; • The electronic throttle control system; • The electronic Multidrive control system. (if equipped)
	SRS warning light Indicates a malfunction in: <ul style="list-style-type: none"> • The SRS airbag system; • The seat belt pretensioner system.
	ABS warning light Indicates a malfunction in: <ul style="list-style-type: none"> • The ABS; • The brake assist system.
	Electric power steering system warning light (warning buzzer) Indicates a malfunction in the EPS system.
 (Flashes)	Cruise control warning light (if equipped) Indicates a malfunction in the cruise control system.
 (Flashes)	Stop & Start cancel indicator light (if equipped) Indicates a malfunction in the Stop & Start system.
 (Comes on)	Slip indicator light Indicates a malfunction in: <ul style="list-style-type: none"> • The VSC+ system; or • The TRC system.

5-2. Steps to take in an emergency

Warning light	Warning light/Details
	<p>Automatic headlight leveling system warning light (if equipped) Indicates a malfunction in the automatic headlight leveling system.</p>

■ If the malfunction indicator lamp comes on while driving

For some models, the malfunction indicator lamp will come on if the fuel tank becomes completely empty. If the fuel tank is empty, refuel the vehicle immediately. The malfunction indicator lamp will go off after several trips.

If the malfunction indicator lamp does not go off, contact any authorized Toyota dealer or repairer, or another duly qualified and equipped professional.

■ Electric power steering system warning light (warning buzzer)

When the battery charge becomes insufficient or the voltage temporarily drops, the electric power steering system warning light may come on and the warning buzzer may sound.



CAUTION

■ When the electric power steering system warning light comes on





The steering wheel may become extremely heavy.
If the steering wheel becomes heavier than usual when operating, hold firmly and operate it using more force than usual.

Follow the correction procedures.

After taking the specified steps to correct the suspected problem, check that the warning light turns off.

Warning light	Warning light/Details	Correction procedure
	<p>Low fuel level warning light</p> <p>Gasoline engine: Indicates that remaining fuel is about 9.0 L (2.4 gal., 2.0 Imp.gal.) or less.</p> <p>Diesel engine: Indicates that remaining fuel is about 8.3 L (2.2 gal., 1.8 Imp.gal.) or less.</p>	Refuel the vehicle.
	<p>Master warning light</p> <p>A buzzer sounds and the warning light comes on or flashes to indicate that the master warning system has detected a malfunction.</p>	Take appropriate action in accordance with the message displayed on the multi-information display.

5-2. Steps to take in an emergency

Warning light	Warning light/Details	Correction procedure
	<p>Tire pressure warning light (if equipped)</p> <p>When the light comes on: Low tire inflation pressure such as</p> <ul style="list-style-type: none"> • Natural causes (→P. 506) • Flat tire (→P. 522, 539) 	<p>Adjust the tire inflation pressure to the specified level.</p> <p>The light will turn off after a few minutes. In case the light does not turn off even if the tire inflation pressure is adjusted, have the system checked by any authorized Toyota dealer or repairer, or another duly qualified and equipped professional.</p>
	<p>When the light comes on after blinking for 1 minute: Malfunction in the tire pressure warning system (→P. 507)</p>	<p>Have the system checked by any authorized Toyota dealer or repairer, or another duly qualified and equipped professional.</p>
 <p>(On the instrument cluster)</p>	<p>Driver's and front passenger's seat belt reminder light (warning buzzer)*1</p> <p>Warns the driver and front passenger to fasten their seat belts.</p>	<p>Fasten the seat belts.</p>
<p>*3</p>  <p>(On the center panel)</p> <p>*4</p>  <p>(On the center panel)</p>	<p>Rear passenger's seat belt reminder light (warning buzzer)*2</p> <p>Warns the rear passenger to fasten his/her seat belt.</p>	<p>Fasten the seat belt.</p>

***1:** Driver's and front passenger's seat belt reminder:

The driver's and front passenger's seat belts reminder sounds to alert the driver and front passenger that their seat belts are not fastened. The buzzer sounds for 30 seconds after the vehicle has reached a speed of at least 20 km/h (12 mph). Then, if the seat belts are still unfastened, the buzzer will sound in a different tone for 90 more seconds.

***2:** Rear passenger's seat belt reminders:

The rear passenger's seat belt reminder sounds to alert the rear passenger that his or her seat belt is not fastened. The buzzer sounds for 30 seconds after the vehicle has reached a speed of at least 20 km/h (12 mph). Then, if the seat belt is still unfastened, the buzzer will sound in a different tone for 90 more seconds.

3:** 5-passenger models4:** 7-passenger models**■ Front passenger detection sensor and passenger seat belt reminder**

- If luggage is placed on the front passenger seat, the front passenger detection sensor may cause the warning light to flash, even if a passenger is not sitting in the seat.
- If a cushion is placed on the seat, the sensor may not detect a passenger, and the warning light may not operate properly.

■ When the tire pressure warning light comes on (vehicles with a tire pressure warning light system)

Inspect the appearance of the tire to check that the tire is not punctured.

If the tire is punctured: →P. 522, 539

If the tire is not punctured:

Carry out the following procedure after the tire temperature has lowered sufficiently.

- Check the tire inflation pressure and adjust to the appropriate level.
- If the warning light does not go out even after several minutes, check that the tire inflation pressure is at the specified level and carry out initialization.

The warning light may come on again if the above operations are conducted without first allowing the tire temperature to lower sufficiently.

5-2. Steps to take in an emergency

■ **The tire pressure warning light may come on due to natural causes (vehicles with a tire pressure warning light system)**

The tire pressure warning light may come on due to natural causes such as natural air leaks and tire inflation pressure changes caused by temperature. In this case, adjusting the tire inflation pressure will turn off the warning light (after a few minutes).

■ **When a tire is replaced with a spare tire (vehicles with a tire pressure warning light system)**

The spare tire is not equipped with a tire pressure warning valve and transmitter. If a tire goes flat, the tire pressure warning light will not turn off even though the flat tire has been replaced with the spare tire. Replace the spare tire with the repaired tire and adjust the tire inflation pressure. The tire pressure warning light will go off after a few minutes.

■ **If the tire pressure warning system is not functioning (vehicles with a tire pressure warning light system)**

The tire pressure warning system will be disabled in the following conditions:
(When the condition becomes normal, the system will work properly.)

- If tires not equipped with tire pressure warning valves and transmitters are used
- If the ID code on the tire pressure warning valves and transmitters is not registered in the tire pressure warning computer
- If the tire inflation pressure is 380 kPa (3.9 kgf/cm² or bar, 55 psi) or higher

The tire pressure warning system may be disabled in the following conditions:

(When the condition becomes normal, the system will work properly.)

- If electronic devices or facilities using similar radio wave frequencies are nearby
- If a radio set at a similar frequency is in use in the vehicle
- If a window tint that affects the radio wave signals is installed
- If there is a lot of snow or ice on the vehicle, particularly around the wheels or wheel housings

- If non-genuine Toyota wheels are used (Even if you use Toyota wheels, the tire pressure warning system may not work properly with some types of tires.)

- If tire chains are used

■ **If the tire pressure warning light frequently comes on after blinking for 1 minute (vehicles with a tire pressure warning light system)**

If the tire pressure warning light frequently comes on after blinking for 1 minute when the engine switch (vehicles without smart entry & start system) or the “ENGINE START STOP” switch (vehicles with smart entry & start system) is turned on, have it checked by any authorized Toyota dealer or repairer, or another duly qualified and equipped professional.

 CAUTION

■ **If the tire pressure warning light comes on (vehicles with a tire pressure warning light system)**

Be sure to observe the following precautions. Failure to do so could cause a loss of vehicle control and result in death or serious injury.

- Stop your vehicle in a safe place as soon as possible. Adjust the tire inflation pressure immediately.
- If the tire pressure warning light comes on even after tire inflation pressure adjustment, it is probable that you have a flat tire. Check the tires. If a tire is flat, change it with the spare tire and have the flat tire repaired by the nearest any authorized Toyota dealer or repairer, or another duly qualified and equipped professional.
- Avoid abrupt maneuvering and braking. If the vehicle tires deteriorate, you could lose control of the steering wheel or the brakes.

■ **If a blowout or sudden air leakage should occur (vehicles with a tire pressure warning light system)**

The tire pressure warning system may not activate immediately.

5-2. Steps to take in an emergency

NOTICE

■ **To ensure the tire pressure warning system operates properly (vehicles with a tire pressure warning light system)**

Do not install tires with different specifications or makers, as the tire pressure warning system may not operate properly.

5-2. Steps to take in an emergency If a warning message is displayed

The multi-information display shows warnings of system malfunctions, incorrectly performed operations, or shows messages that indicate a need for maintenance. When a message is shown, perform the correction procedure appropriate to the message.

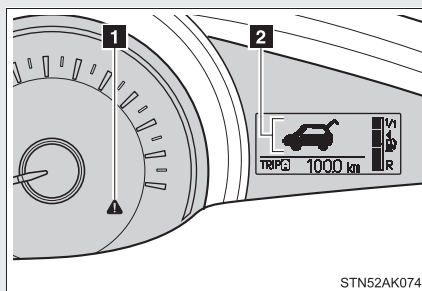

1 Master warning light



The master warning light comes on or flashes when a message is being shown on the multi-information display.

2 Multi-information display

If any of the warning messages is shown again after its correction procedure has been performed, contact any authorized Toyota dealer or repairer, or another duly qualified and equipped professional.







Stop the vehicle immediately.

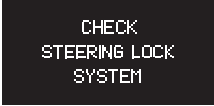

The following warnings indicate the possibility of damage to the vehicle that may lead to an accident. Immediately stop the vehicle in a safe place and contact any authorized Toyota dealer or repairer, or another duly qualified and equipped professional.

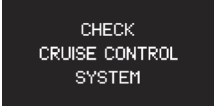
Warning message	Details
 	<p>Indicates an abnormal engine oil pressure.</p> <p>A buzzer also sounds.</p> <p>The warning light may turn on if the engine oil pressure is too low.</p>

Have the vehicle inspected immediately.

Failing to investigate the cause of the following warnings may lead to the system operating abnormally and possibly cause an accident. Have the vehicle inspected by any authorized Toyota dealer or repairer, or another duly qualified and equipped professional, immediately.



Warning message	Details
<p style="text-align: right;">*</p>    <p>(Amber indicator flashes)</p>	<p>Indicates a malfunction in the steering lock system. A buzzer also sounds.</p>
 	<p>Indicates a malfunction in the cruise control system. (if equipped) Press the “ON-OFF” button once to deactivate the system, and then press the button again to reactivate the system.</p>
 	<p>Indicates a malfunction in the speed limiter system. (if equipped) A buzzer also sounds.</p>

Warning message	Details
<p style="text-align: right;">*</p> <div style="background-color: black; color: white; padding: 5px; text-align: center; margin-bottom: 5px;"> CHECK CLUTCH SWITCH </div>   <p>(Green indicator flashes)</p>	<p>Indicates a malfunction in the clutch start system. A buzzer also sounds.</p>

*: Vehicles with smart entry & start system

Follow the correction procedures.

A buzzer sounds and a warning message is shown on the multi-information display. After taking the specified steps to correct the suspected problem, check that the warning light turns off.

Warning message	Details	Correction procedure
	<p>Indicates that one or more of the side doors is not fully closed.</p> <p>The system also indicates which doors are not fully closed. A buzzer sounds to indicate that one or more of the doors is not fully closed (with the vehicle having reached a speed of 5 km/h [3 mph]).</p>	<p>Make sure that all of the side doors are closed.</p>
	<p>Indicates that the back door is not fully closed.</p> <p>A buzzer sounds to indicate that one or more of the doors is not fully closed (with the vehicle having reached a speed of 5 km/h [3 mph]).</p>	<p>Close the back door.</p>

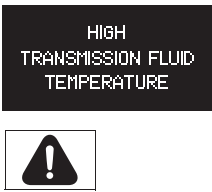
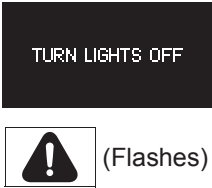
Warning message	Details	Correction procedure
 <p>RELEASE PARKING BRAKE</p> <p>(Flashes)</p>	<p>Indicates that the parking brake is still engaged.</p> <p>A buzzer sounds to indicate that parking brake is still engaged (with the vehicle having reached a speed of more than 5 km/h [3 mph]).</p>	<p>Release the parking brake.</p>
<p style="text-align: right;">*1</p>  <p>HIGH TRANSMISSION FLUID TEMPERATURE</p>	<p>Indicates that the Multidrive fluid temperature is too high.</p> <p>A buzzer also sounds.</p>	<p>Stop the vehicle in a safe place and shift lever to "P".</p> <p>If the light does not go off, contact any authorized Toyota dealer or repairer, or another duly qualified and equipped professional.</p>
 <p>TURN LIGHTS OFF</p> <p>(Flashes)</p>	<p>Indicates that the headlight switch is left on (with the key removed and the driver's door opened).</p> <p>A buzzer also sounds.</p>	<p>Turn the headlight switch off.</p>

5-2. Steps to take in an emergency

Warning message	Details	Correction procedure
<p style="text-align: right;">*2</p> <div style="background-color: black; color: white; padding: 5px; text-align: center; width: fit-content; margin: 0 auto;"> OIL MAINTENANCE REQUIRED SOON </div>	<p>Indicates that engine oil is scheduled to be changed. (The indicator will not work properly unless the oil maintenance data has been reset.)</p>	<p>Check the level of engine oil, and add if necessary. If necessary, have the engine oil changed by any authorized Toyota dealer or repairer, or another duly qualified and equipped professional. After changing the engine oil, the oil change system should be reset.</p>
<p style="text-align: right;">*2</p> <div style="background-color: black; color: white; padding: 5px; text-align: center; width: fit-content; margin: 0 auto;"> OIL MAINTENANCE REQUIRED </div>	<p>Indicates that the engine oil scheduled be changed. (After the engine oil is changed and the oil maintenance data has been reset.)</p>	<p>Check and have the engine oil and oil filter changed by any authorized Toyota dealer or repairer, or another duly qualified and equipped professional. After changing the engine oil, the oil change system should be reset.</p>

Warning message	Details	Correction procedure
 <p style="text-align: right;">*2</p>	<ul style="list-style-type: none"> • Indicates that the DPF catalytic converter needs to be cleaned due to repeated short trips and/or low-speed driving. • Indicates that the amount of accumulated deposits in the DPF catalytic converter has reached the specified level. 	<p>To clean the DPF catalytic converter, drive the vehicle at a speed of 65 km/h (40 mph) or greater for 20 to 30 minutes as much as possible until the warning message turns off.</p> <p>Do not turn off the engine as much as possible until the warning message turns off.</p> <p>If it is not possible to drive the vehicle at speeds of 65 km/h (40 mph) or greater, or the DPF system warning light does not turn off even after driving for more than 30 minutes, have the vehicle inspected by any authorized Toyota dealer or repairer, or another duly qualified and equipped professional.</p>





*1: Vehicles with a Multidrive







*2: Diesel engine only

5-2. Steps to take in an emergency







Follow the correction procedures. (vehicles with smart entry & start system)



After taking the specified steps to correct the suspected problem, check that the warning light turns off.

Interior buzzer	Exterior buzzer	Warning message	Details	Correction procedure
Once	—	  (Flashes)	Indicates that an attempt was made to start the engine without the electronic key being present, or the electronic key was not functioning normally.	Confirm the location of the electronic key.
Once	3 times	  (Flashes)	Indicates that a door other than the driver's door has been opened or closed with the "ENGINE START STOP" switch in any mode other than off and the electronic key outside of the detection area.	Confirm the location of the electronic key.

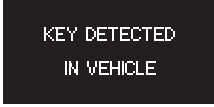





Interior buzzer	Exterior buzzer	Warning message	Details	Correction procedure
Once	3 times	<p style="text-align: right;">*1</p>   (Flashes)	Indicates that the driver's door has been opened or closed with the shift lever in "P", the "ENGINE START STOP" switch in any mode other than off and the electronic key outside of the detection area.	Turn the "ENGINE START STOP" switch off or confirm the location of the electronic key.
—	Continuous	  (Displayed alternately)  (Flashes)	Indicates that all doors have been closed and locked, the "ENGINE START STOP" switch is in any mode other than off, and the electronic key is outside of the detection area.	Turn the "ENGINE START STOP" switch off. After lock the door.
Once	—	  (Flashes)	Indicates that driving the vehicle when the electronic key outside of the detection area.	Confirm the location of the electronic key to inside of the vehicle.

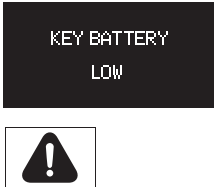

5-2. Steps to take in an emergency

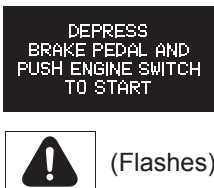
Interior buzzer	Exterior buzzer	Warning message	Details	Correction procedure
Continuous	—	<p style="text-align: right;">*1</p>  <p>SHIFT TO P POSITION</p>  (Flashes)	Indicates that the driver's door has been opened with the shift lever out of in "P", the "ENGINE START STOP" switch in any mode other than off.	Shift the shift lever to "P".
Continuous	Continuous	 <p>SHIFT TO P POSITION</p>  <p>KEY NOT DETECTED</p> <p>(Displayed alternately)</p>  (Flashes)	Indicates that the driver's door has been opened or closed with the shift the shift lever out of in "P", the "ENGINE START STOP" switch in any mode other than off and the electronic key outside of the detection area.	<ul style="list-style-type: none"> • Shift the shift lever to "P". • Confirm the location of the electronic key.
Once	Continuous	 <p>KEY DETECTED IN VEHICLE</p>  (Flashes)	Indicates that a door has been closed and the electronic key leave in the vehicle.	Take the electronic key outside of the vehicle. After lock the door.

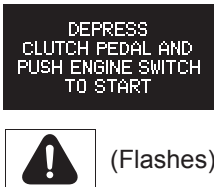
Interior buzzer	Exterior buzzer	Warning message	Details	Correction procedure
Once	—	<p style="text-align: right;">*1</p> <div style="background-color: black; color: white; padding: 5px; text-align: center;"> DEPRESS BRAKE PEDAL, TOUCH ENGINE SWITCH WITH KEY </div>  (Flashes)	Indicates that the electronic key does not operate properly.	Press the “ENGINE START STOP” switch while applying the brakes.
Once	—	<p style="text-align: right;">*2</p> <div style="background-color: black; color: white; padding: 5px; text-align: center;"> DEPRESS CLUTCH PEDAL, TOUCH ENGINE SWITCH WITH KEY </div>  (Flashes)	Indicates that the electronic key does not operate properly.	Press the “ENGINE START STOP” switch while applying the clutch pedal.
Once	—	<p style="text-align: right;">*1</p> <div style="background-color: black; color: white; padding: 5px; text-align: center;"> SHIFT TO P POSITION AND PUSH ENGINE SWITCH TO TURN POWER OFF </div>  (Flashes)	Indicates that the shift lever out of “P” or “N” and turned to the “ENGINE START STOP” switch off.	Turn the “ENGINE START STOP” switch off to after shift the shift lever to “P”.
—	—	<div style="background-color: black; color: white; padding: 5px; text-align: center;"> AUTO POWER OFF TO CONSERVE BATTERY </div>	Indicates that the auto power off function.	Start the engine. Increase the engine speed slightly and maintain at that level for approximately 5 minutes to recharge the battery of your vehicle.

5-2. Steps to take in an emergency

Interior buzzer	Exterior buzzer	Warning message	Details	Correction procedure
Once	—	 <p>KEY BATTERY LOW</p> 	Indicates that the key battery is low.	Replace the battery.
Once	—	 <p>*1 DEPRESS BRAKE PEDAL AND PUSH ENGINE SWITCH TO START</p>  (Flashes)	Indicates that a door has been opened or closed and the “ENGINE START STOP” switch has been switched twice to ACCESSORY mode from off.	Press the “ENGINE START STOP” switch while applying the brakes.
Once	—	 <p>*2 DEPRESS CLUTCH PEDAL AND PUSH ENGINE SWITCH TO START</p>  (Flashes)	Indicates that a door has been opened or closed and the “ENGINE START STOP” switch has been switched twice to ACCESSORY mode from off.	Press the “ENGINE START STOP” switch while applying the clutch pedal.

Interior buzzer	Exterior buzzer	Warning message	Details	Correction procedure
Once	—	  (Flashes)  (Green indicator flashes)	Indicates that the steering lock has not released within 3 seconds of pressing the “ENGINE START STOP” switch.	Press the “ENGINE START STOP” switch again while turning the steering wheel with the brake pedal depressed.

*1: Vehicles with a Multidrive

*2: Vehicles with a manual transmission

5-2. Steps to take in an emergency

If you have a flat tire (vehicles with spare tire)

Your vehicle is equipped with a spare tire. The flat tire can be replaced with the spare tire.

■ Before jacking up the vehicle

- Stop the vehicle on a hard, flat surface.
- Set the parking brake.
- Shift the shift lever to “P” (Multidrive) or “R” (manual transmission).
- Stop the engine.
- Turn on the emergency flashers. (→P. 490)

■ Location of the spare tire, jack and tools

► Vehicles without the third seat

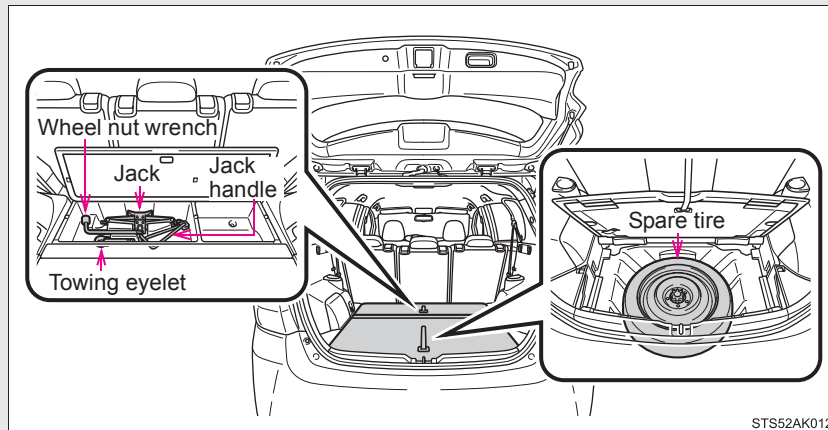

► Vehicles with third seats

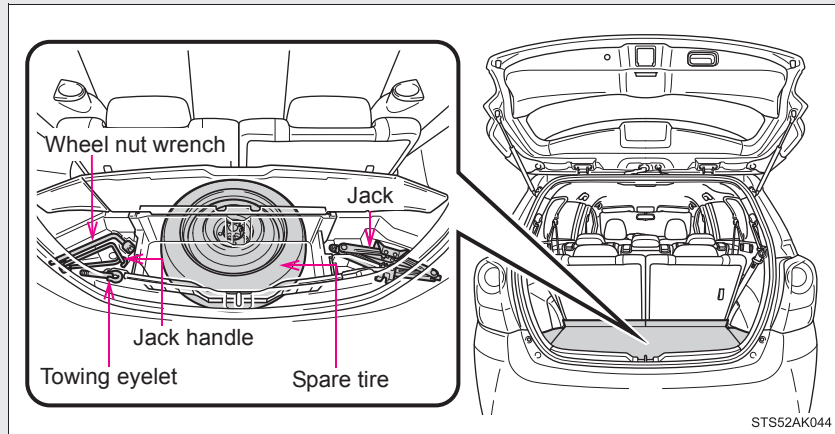

5-2. Steps to take in an emergency

Taking out the jack (vehicles without the third seat)

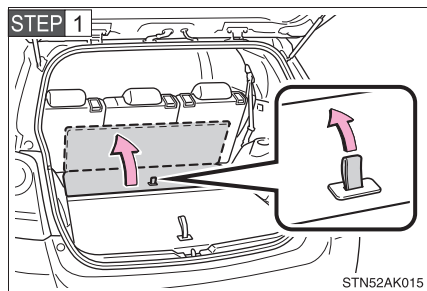

Open the front deck board.

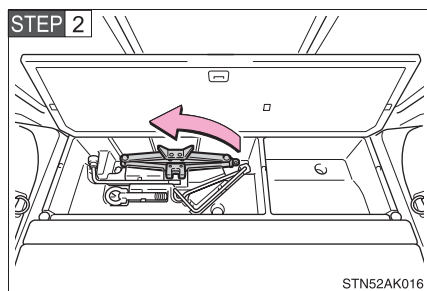

Remove the jack.

Taking out the spare tire (vehicles without the third seat)

STEP 1 Open the rear deck board.

► Vehicles with a standard spare tire

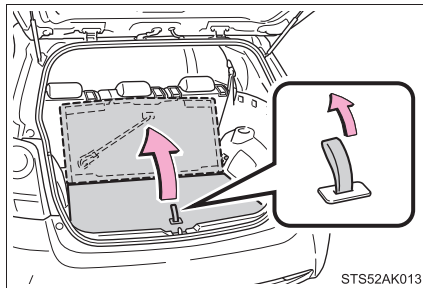

► Vehicles with a compact spare tire

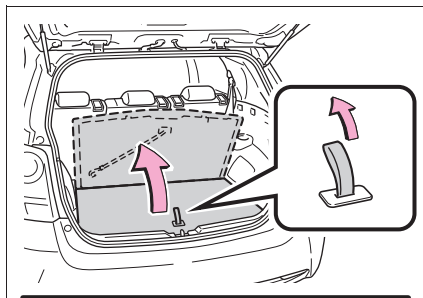

Secure the rear deck board, using the strap hook provided.

- 1** Remove the strap hook
- 2** Secure the hook

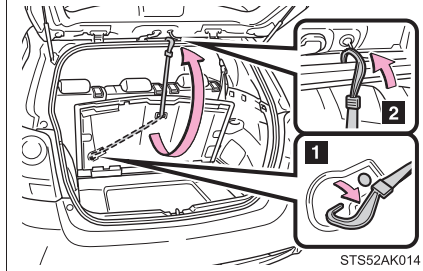

5-2. Steps to take in an emergency

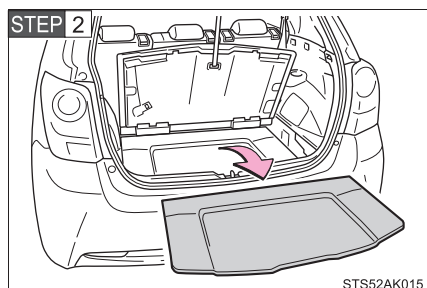

Remove the cover.

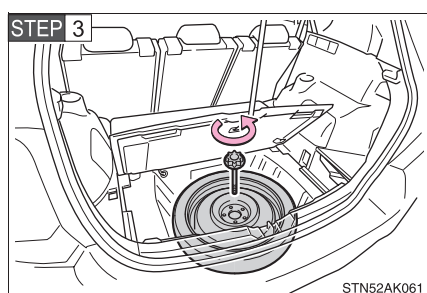

Loosen the center fastener that secures the spare tire.

STEP 4 Take out the spare tire.

► Vehicles with a standard spare tire

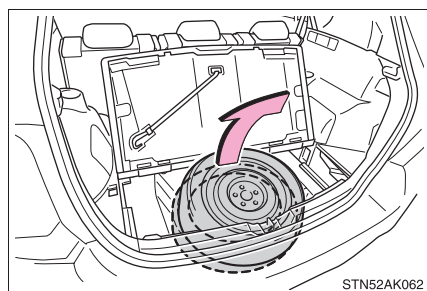

► Vehicles with a compact spare tire

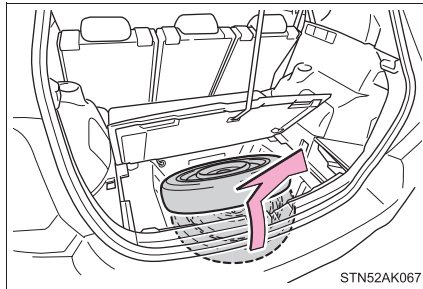

Taking out the jack and spare tire (vehicles with the third seat)

STEP 1 Make sure that the third seat is in the most upright position.

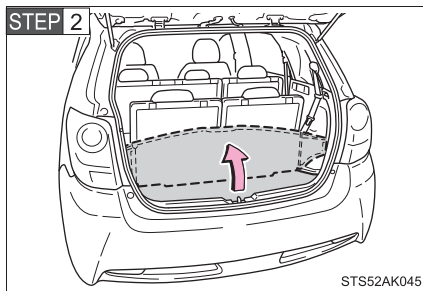

Open the deck board.

Be careful of the deck board unexpectedly falling forward.

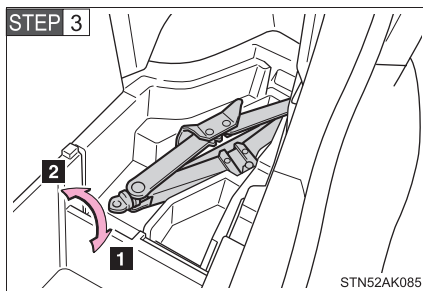

Take out the jack.

- 1** Tighten
- 2** Loosen

5-2. Steps to take in an emergency

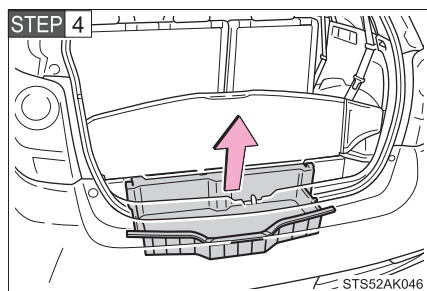

Remove the auxiliary box.

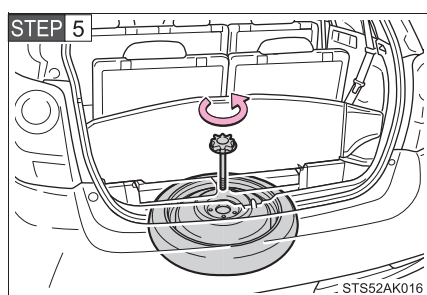

Loosen the center fastener that secures the spare tire.

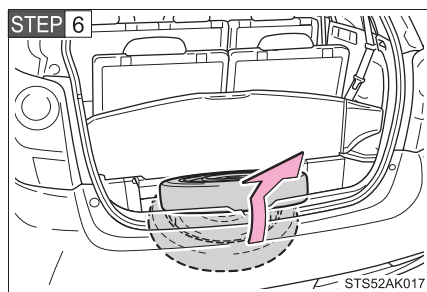

Take out the spare tire.

The spare tire cannot be taken out while the third seat is folded down.

Replacing a flat tire

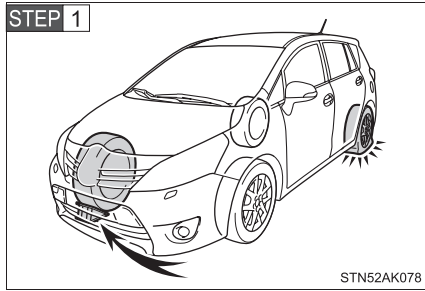

Chock the tires.

Flat tire		Wheel chock positions
Front	Left-hand side	Behind the rear right-hand side tire
	Right-hand side	Behind the rear left-hand side tire
Rear	Left-hand side	In front of the front right-hand side tire
	Right-hand side	In front of the front left-hand side tire

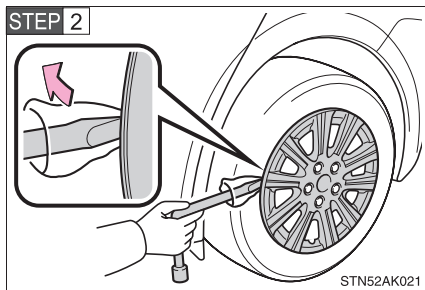

Vehicles with a steel wheel, remove the wheel ornament using the wrench or the wheel cap clip. (→P. 448)

To protect the wheel ornament, place a rag between the wrench and the wheel ornament, as shown in the illustration.

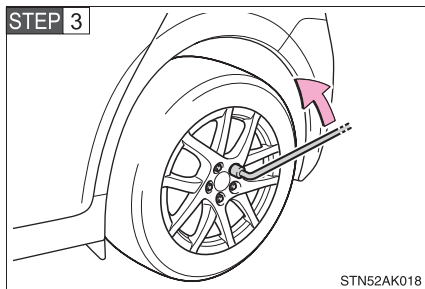

Slightly loosen the wheel nuts (one turn).

5-2. Steps to take in an emergency

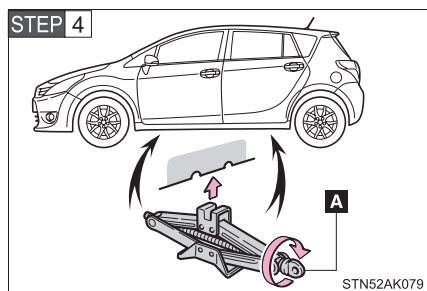

Turn the tire jack portion "A" by hand until the notch of the jack is in contact with the jack point.

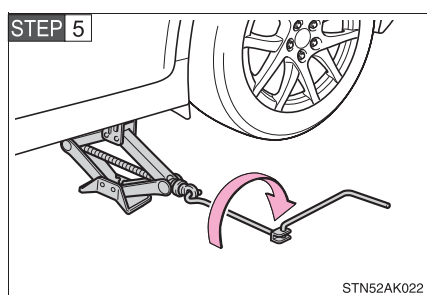

Raise the vehicle until the tire is slightly raised off the ground.

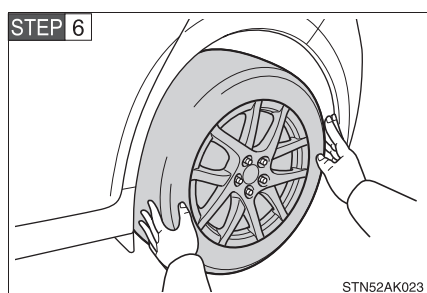

Remove all the wheel nuts and the tire.

When resting the tire on the ground, place the tire so that the wheel design faces up to avoid scratching the wheel surface.

Installing the spare tire

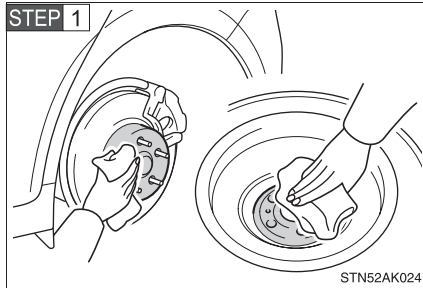

Remove any dirt or foreign matter from the wheel contact surface.

If foreign matter is on the wheel contact surface, the wheel nuts may loosen while the vehicle is in motion, and the tire may come off the vehicle.

STEP 2 Install the tire and loosely tighten each wheel nut by hand by approximately the same amount.

► Replacing a steel wheel with a steel wheel (including a compact spare tire)

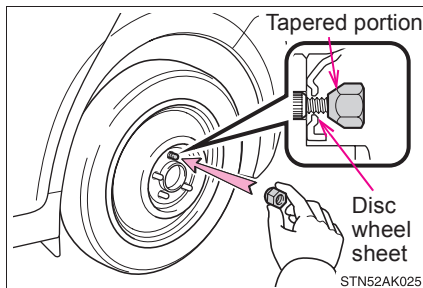

Tighten the nuts until the tapered portion comes into loose contact with the disc wheel sheet.

► Replacing an aluminum wheel with a steel wheel (including a compact spare tire)

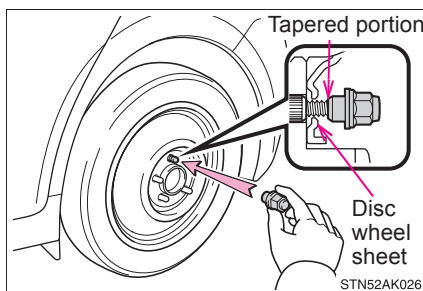

Tighten the nuts until the tapered portion comes into loose contact with the disc wheel sheet.

5-2. Steps to take in an emergency

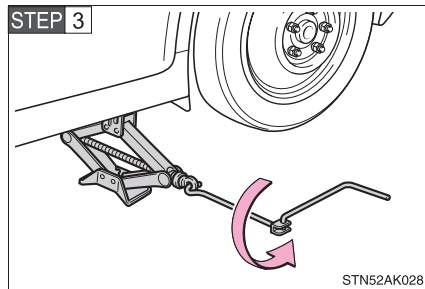

Lower the vehicle.

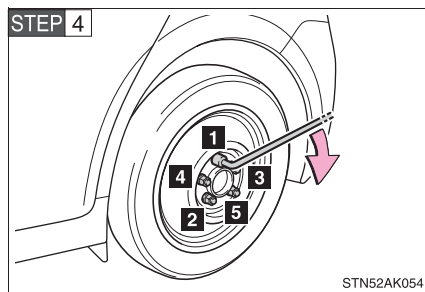

Firmly tighten each wheel nut two or three times in the order shown in the illustration.

Tightening torque:
103 N·m (10.5 kgf·m, 76 ft·lbf)

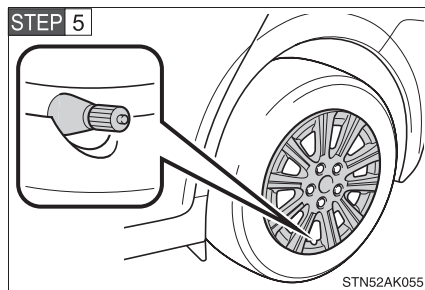

Vehicles with a steel wheels, except for vehicles with a tire pressure warning system or a compact spare tire: Reinstall the wheel ornament.

Align the cutout of the wheel ornament with the valve stem as shown.

STEP 6 Stow the flat tire, tire jack and all tools.

■ **The compact spare tire (if equipped)**

- The compact spare tire is identified by the label “TEMPORARY USE ONLY” on the tire sidewall.
Use the compact spare tire temporarily only in an emergency.
- Make sure to check the tire inflation pressure of the compact spare tire.
(→P. 595)

■ **After completing the tire change (vehicles with the tire pressure warning system)**

The tire pressure warning system must be reset. (→P. 433)

■ **When using the spare tire (vehicles with the tire pressure warning system)**

As the spare tire is not equipped with a tire pressure warning valve and transmitter, low inflation pressure of the spare tire will not be indicated by the tire pressure warning system. Also, if you replace a flat tire with the spare tire after the tire pressure warning light comes on, the light remains on.

■ **If you have a flat front tire on a road covered with snow or ice (vehicles with compact spare tire)**

Install the compact spare tire on the rear of the vehicle. Perform the following steps and fit tire chains to the front tires.

STEP 1 Replace a rear tire with the compact spare tire.

STEP 2 Replace the flat front tire with the tire removed from the rear of the vehicle.

STEP 3 Fit tire chains to the front tires.

■ **Certification for the jack**



Manufacturer's Declaration of Conformity

Manufacturer :

ARIKAN KRİKO A.Ş
Organize Sanayi Bölgesi 2.Cd.26110 ESKİŞEHİR / TURKEY

The EU Directives covered by this Declaration

2006 / 42 / EC Machinery Directive

The product covered by this declaration

JACK SUB-ASSY. PANTOGRAPH
model
0.8 ton , 1.1 ton

The basis on which conformity is being declared

The product identified above complies with the requirements of
the Machinery Directive
Directive above by meeting following standards

857 – ISO 8720

The technical documentation required to demonstrate that the product
meets the requirement the Machinery Directive has been compiled by
the signatory below and is available for inspection by the relevant
enforcement authorities.

A sample of the product has been tested by the manufacturer

Technical File No :2010-TOYOTA JACK-ISO8720-1

The CE mark was first applied in:2010

Done at Shizuoka , Japan

Ahmet ARIKAN
General Manager

Signature :

Date of Issue : 24.08.2010

⚠ CAUTION**■ Using the tire jack**

Improper use of the tire jack may lead to death or serious injury due to the vehicle suddenly falling off the jack.

- Do not use the tire jack for any purpose other than replacing tires or installing and removing tire chains.
- Only use the tire jack that comes with this vehicle for replacing a flat tire. Do not use it on other vehicles, and do not use other tire jacks for replacing tires on this vehicle.
- Always check that the tire jack is securely set to the jack point.
- Do not put any part of your body under the vehicle supported by a jack.
- Do not start or run the engine while your vehicle is supported by the jack.
- Do not raise the vehicle while someone is in it.
- When raising the vehicle, do not put an object on or under the jack.
- Do not raise the vehicle to a height greater than that required to replace the tire.
- Use a jack stand if it is necessary to get under the vehicle.

Take particular care when lowering the vehicle to ensure that no one working on or near the vehicle will be injured.

■ Replacing a flat tire

- Observe the following precautions.
 - Failure to do so may result in serious injury:
 - Do not try to remove the wheel ornament by hand. Take due care in handling the ornament to avoid unexpected personal injury.
 - Do not touch the disc wheels or the area around the brakes immediately after the vehicle has been driven.
After the vehicle has been driven the disc wheels and the area around the brakes will be extremely hot. Touching these areas with hands, feet or other body parts while changing a tire, etc. may result in burns.

 CAUTION

■ **Replacing a flat tire**

- Failure to follow these precautions could cause the wheel nuts to loosen and the tire to fall off, resulting in death or serious injury.
 - Have the wheel nuts tightened with a torque wrench to 103 N·m (10.5 kgf·m, 76 ft·lbf) as soon as possible after changing wheels.
 - When installing a tire, only use wheel nuts that have been specifically designed for that wheel.
 - If there are any cracks or deformations in the bolt screws, nut threads or bolt holes of the wheel, have the vehicle inspected by any authorized Toyota dealer or repairer, or another duly qualified and equipped professional.
 - When installing the wheel nuts, be sure to install them with the tapered ends facing inward. (→P. 449)
 - Do not attach a heavily damaged wheel ornament, as it may fly off the wheel while the vehicle is moving.

■ **When using the full-size spare tire (vehicles with the tire pressure warning system or a spare tire of different wheel type from the installed tires)**

- Replace the full-size spare tire with a standard tire as soon as possible.
- Avoid sudden acceleration, deceleration and braking, as well as sharp cornering.

■ **When using the compact spare tire**

- Remember that your compact spare tire is specifically designed for use with your vehicle. Do not use your compact spare tire on another vehicle.
- Do not use more than one compact spare tire simultaneously.
- Replace the compact spare tire with a standard tire as soon as possible.
- Avoid sudden acceleration, abrupt steering, sudden braking and shifting operations that cause sudden engine braking.

 CAUTION

■ **Speed limit when using the compact spare tire**

Do not drive at speeds in excess of 80 km/h (50 mph) when a compact spare tire is installed on the vehicle.

The compact spare tire is not designed for driving at high speeds. Failing to observe this precaution may lead to an accident causing death or serious injury.

■ **When the spare tire is installed**

The vehicle speed may not be correctly detected, and the following systems may not operate correctly:

- ABS & brake assist
- VSC+
- TRC
- Cruise control (if equipped)
- Navigation system (if equipped)

 NOTICE

■ **Do not drive the vehicle with a flat tire**

Do not continue driving with a flat tire.

Driving even a short distance with a flat tire can damage the tire and the wheel beyond repair.

■ **Be careful when driving over bumps with the compact spare tire installed on the vehicle**

The vehicle becomes lower when driving with the compact spare tire compared to when driving with standard tires. Be careful when driving over uneven road surfaces.

■ **Driving with tire chains and the compact spare tire**

Do not fit tire chains to the compact spare tire.

Tire chains may damage the vehicle body and adversely affect driving performance.

■ **When replacing the tires (vehicles with the tire pressure warning system)**

When removing or fitting the wheels, tires or the tire pressure warning valve and transmitter, contact any authorized Toyota dealer or repairer, or another duly qualified and equipped professional as the tire pressure warning valve and transmitter may be damaged if not handled correctly.

5-2. Steps to take in an emergency

If you have a flat tire (vehicles with emergency tire puncture repair kit)

Your vehicle is not equipped with a spare tire, but instead is equipped with an emergency tire puncture repair kit.

A puncture caused by a nail or screw passing through the tire tread can be repaired temporarily using the emergency tire puncture repair kit. (The kit contains a bottle of sealant. The sealant can be used only once to temporarily repair one tire without removing the nail or screw from the tire.) Depending on the damage, this kit cannot be used to repair the tire. (→P. 542)

After temporarily repairing the tire with the kit, have the tire repaired or replaced by any authorized Toyota dealer or repairer, or another duly qualified and equipped professional. Repairs conducted using the emergency tire puncture repair kit are only a temporary measure. Have the tire repaired and replaced as soon as possible.

■ Before repairing the vehicle

- Stop the vehicle in a safe place on a hard, flat surface.
- Set the parking brake.
- Shift the lever to “P” (Multidrive) or “N” (manual transmission).
- Stop the engine.
- Turn on the emergency flashers. (→P. 490)

5-2. Steps to take in an emergency

■ Location of the emergency tire puncture repair kit

► Vehicles without the third seats

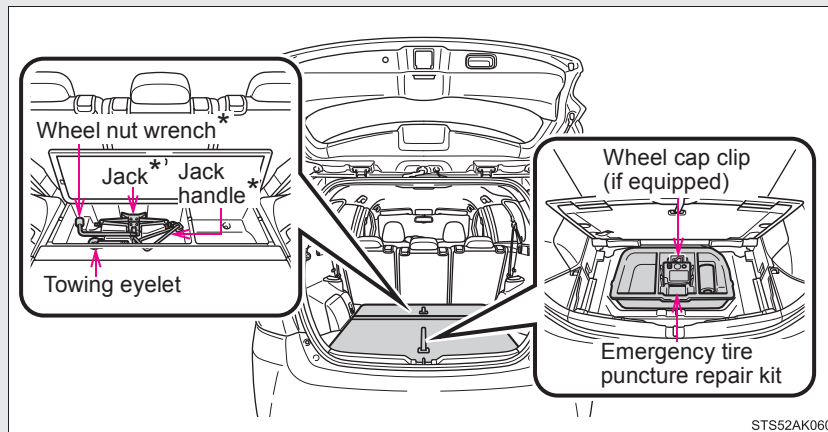

► Vehicles with the third seats

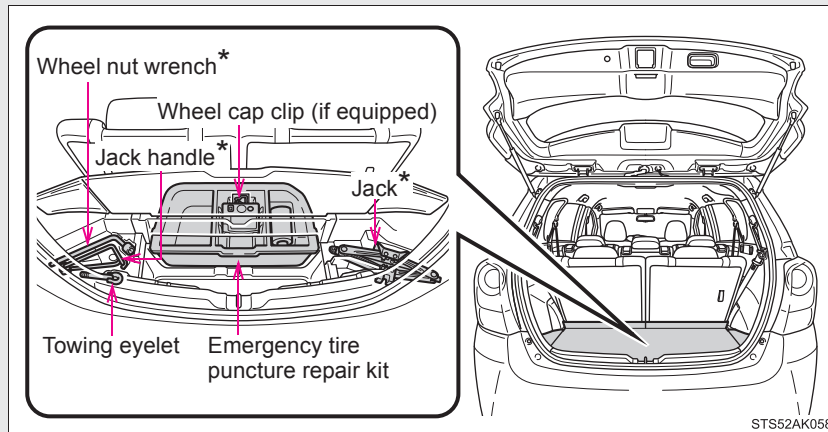

*: Use of the jack, jack handle and wheel nut wrench. (if equipped)
(→P. 522)

A jack, jack handle and wheel nut wrench can be purchased at any authorized Toyota dealer or repairer, or another duly qualified and equipped professional.

■ Emergency tire puncture repair kit components

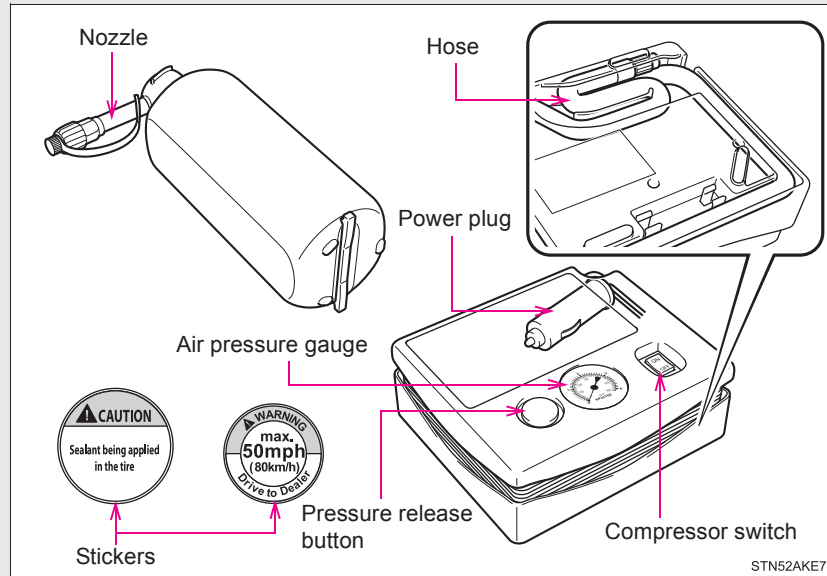

Before performing emergency repair

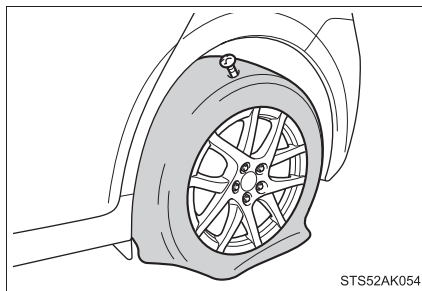

Check the degree of the tire damage.

- Do not remove the nail or screw from the tire. Removing the object may widen the opening and prevent emergency repair with the repair kit.
- To avoid sealant leakage, move the vehicle until the area of the puncture, if known, is positioned at the top of the tire.

■ **In the following cases, the tire cannot be repaired with the emergency tire puncture repair kit. Contact any authorized Toyota dealer or repairer, or another duly qualified and equipped professional.**

- When the tire is damaged due to driving without sufficient air pressure
- When there are any cracks or damage at any location on the tire, such as on the side wall, except the tread
- When the tire is visibly separated from the wheel
- When the cut or damage to the tread is 4 mm (0.16 in.) long or more
- When the wheel is damaged
- When two or more tires have been punctured
- When more than 2 sharp objects such as nails or screws have passed through the tread on a single tire
- When the sealant has expired

Taking out the emergency tire puncture repair kit

STEP 1 Open the rear deck board. (→P. 386)

STEP 2 Take out the emergency tire puncture repair kit. (→P. 540)

Emergency repair method

STEP 1 Take out the repair kit from the tool box.

When taking out the bottle from the original bag, do not tear or discard the bag.

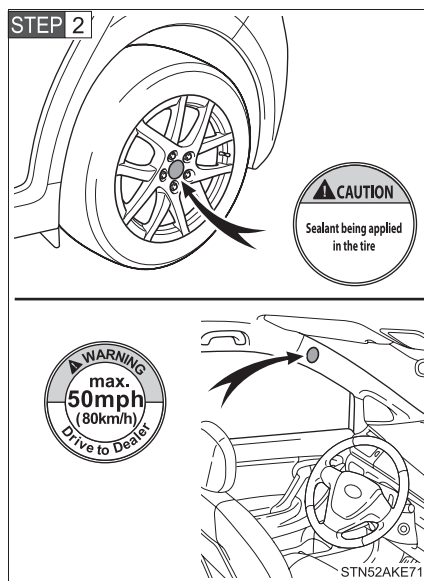

Attach the 2 stickers as shown.

Remove any dirt and moisture from the wheel before attaching the label. If it is impossible to attach the label, make sure to tell any authorized Toyota dealer or repairer, or other duly qualified and equipped professional when you have them repair and replace the tire that sealant is injected.

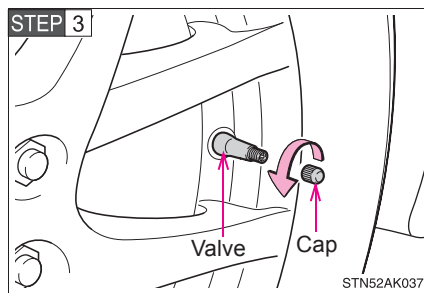

Remove the valve cap from the valve of the punctured tire.

5-2. Steps to take in an emergency

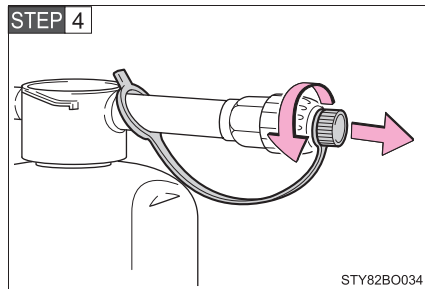

Remove the cap from the nozzle.

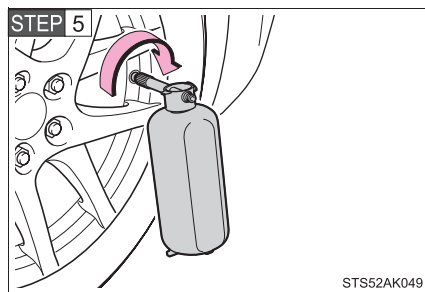

Connect the nozzle to the valve.

Screw the end of the nozzle clockwise as far as possible.

The bottle should hang vertically without contacting the ground. If the bottle does not hang vertically, move the vehicle so that the tire valve is located properly.

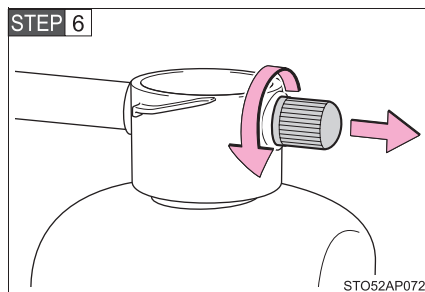

Remove the cap from the bottle.

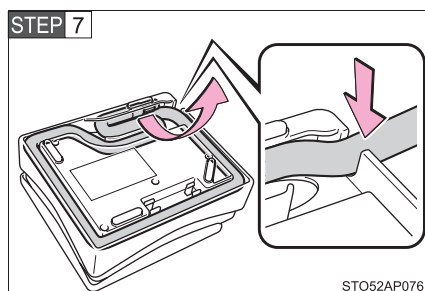

Pull the hose out from the compressor.

5-2. Steps to take in an emergency

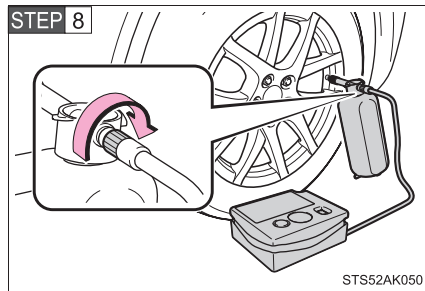

Connect the bottle to the compressor.

Screw the end of the nozzle clockwise as far as possible.

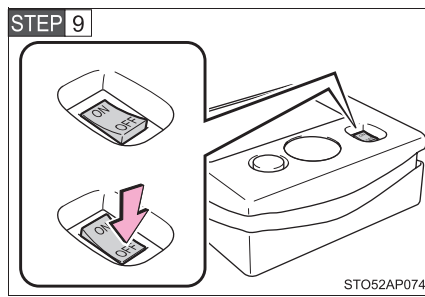

Make sure that the compressor switch is off.

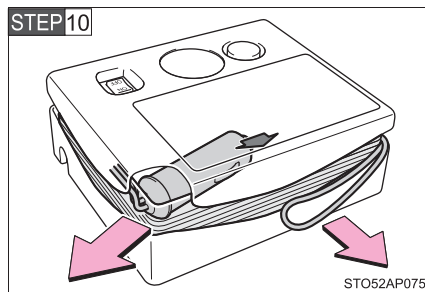

Remove the power plug from the compressor.

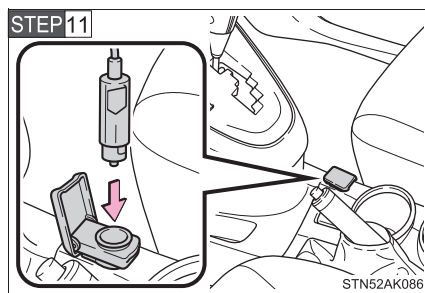

Connect the power plug to the power outlet socket. (→P. 374)

5-2. Steps to take in an emergency

STEP 12 Check the specified inflation pressure.

The label is placed as shown in the illustration.

► Left-hand drive vehicles

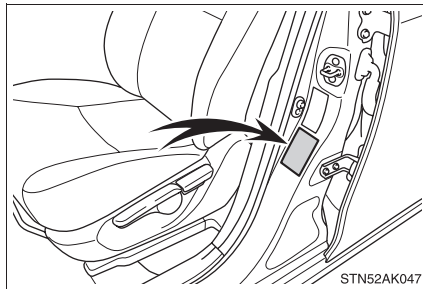

► Right-hand drive vehicles

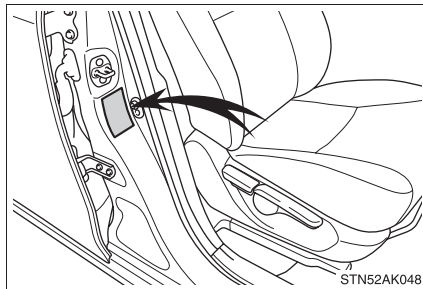

STEP 13 Start the vehicle's engine.

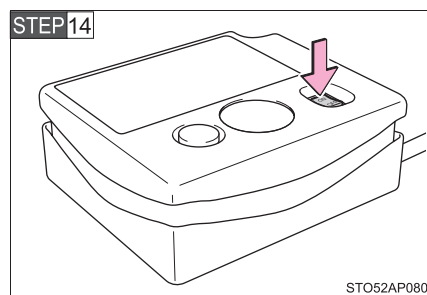

To inject the sealant and inflate the tire, turn the compressor switch on.

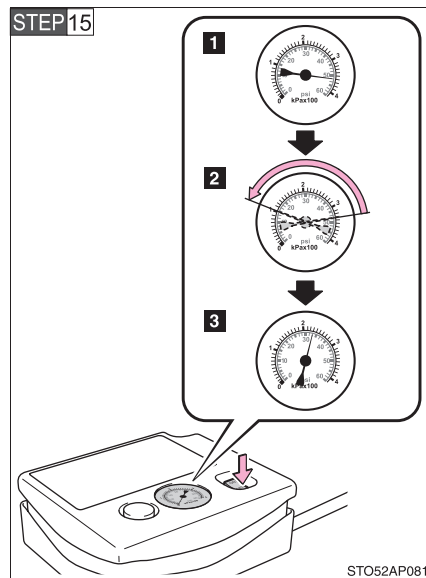

Inflate the tire until the specified air pressure is reached.

1 The sealant will be injected and the pressure will surge and then gradually decrease.

2 The air pressure gauge will display the actual tire inflation pressure about 1 minute (5 minutes at low temperature) after the switch is turned on.

3 Inflate the tire until the specified air pressure.

- If the tire inflation pressure is still lower than the specified point after inflation for 35 minutes with the switch on, the tire is too damaged to be repaired. Turn the compressor switch off and contact any authorized Toyota dealer or repairer, or another duly qualified and equipped professional.
- If the tire inflation pressure exceeds the specified air pressure, let out some air to adjust the tire inflation pressure. (→P. 550, 595)

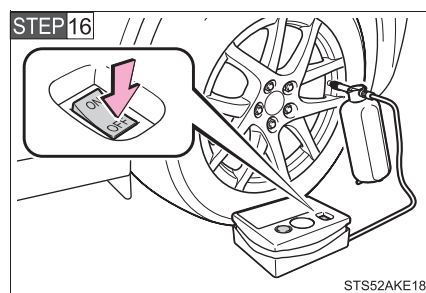

Turn the compressor off.

5-2. Steps to take in an emergency

- STEP 17** Disconnect the nozzle from the valve on the tire and then pull out the power plug from the power outlet socket.
Some sealant may leak when the hose is removed.

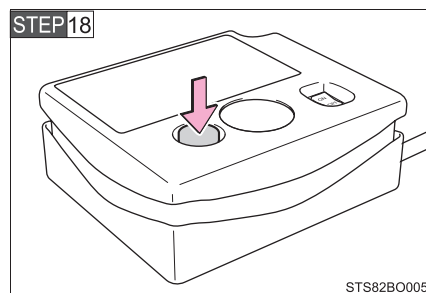

Press the button to release pressure from the bottle.

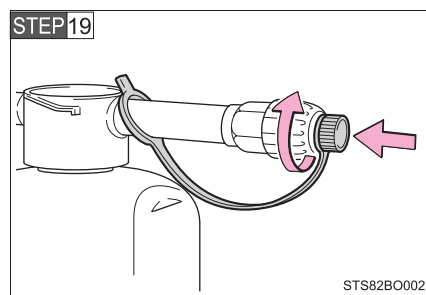

Attach the cap to the nozzle.

- STEP 20** Install the valve cap onto the valve of the repaired tire.

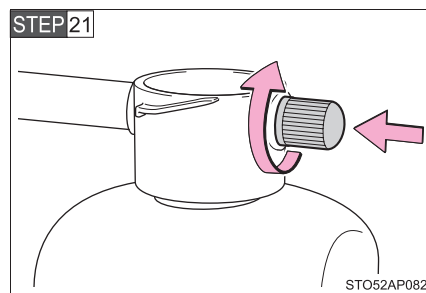

Disconnect the hose from the bottle and attach the cap to the bottle.

Place the bottle in the original bag and zip it.

- STEP 22** Temporarily store the bottle and compressor in the luggage compartment.

- STEP 23** To spread the liquid sealant evenly within the tire, immediately drive safely for about 5 km (3 miles) below 80 km/h (50 mph).

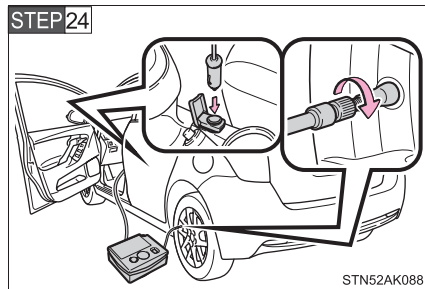

After driving for about 5 km (3 miles), stop your vehicle in a safe place on a hard, flat surface and connect the compressor.

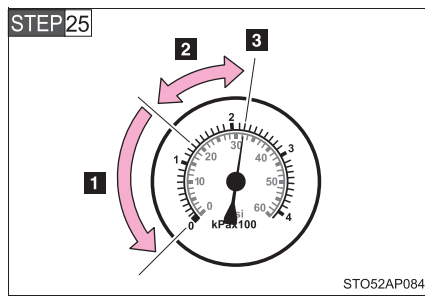

Check the tire inflation pressure.

- 1 If the tire inflation pressure is under 130 kPa (1.3 kgf/cm² or bar, 19 psi): The puncture cannot be repaired. Contact any authorized Toyota dealer or repairer, or another duly qualified and equipped professional.
- 2 If the tire inflation pressure is 130 kPa (1.3 kgf/cm² or bar, 19 psi) or higher, but less than the specified air pressure: Proceed to **STEP 26**.
- 3 If the tire inflation pressure is the specified air pressure (→P. 595): Proceed to **STEP 27**.

STEP 26 Turn the compressor switch on to inflate the tire until the specified air pressure is reached. Drive for about 5 km (3 miles) and then perform **STEP 24**.

STEP 27 Store the compressor in the luggage compartment.

5-2. Steps to take in an emergency

STEP 28 Taking precautions to avoid sudden braking, sudden acceleration and sharp turns, drive carefully at under 80 km/h (50 mph) to the nearest authorized Toyota dealer or repairer, or another duly qualified and equipped professional for tire repair or replacement.

■ If the tire is inflated to more than the specified air pressure

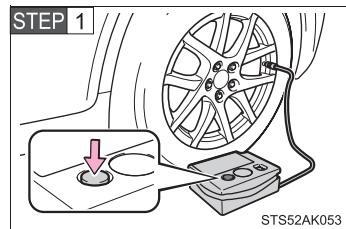

Press the button to let some air out.

STEP 2 Check that the air pressure indicator shows the specified air pressure.

If the air pressure is under the designated pressure, turn the compressor switch on again and repeat the inflation procedure until the specified air pressure is reached.

■ After a tire is repaired with the emergency tire puncture repair kit

- The tire pressure warning valve and transmitter should be replaced.
- Even if the tire inflation pressure is at the recommended level, the tire pressure warning light may come on/flash.

■ Note for checking the emergency tire puncture repair kit

Check the sealant expiry date occasionally.

The expiry date is shown on the bottle. Do not use sealant whose expiry date has already passed. Otherwise, repairs conducted using the emergency tire puncture repair kit may not be performed properly.

■ **Emergency tire puncture repair kit**

- The sealant stored in the emergency tire puncture repair kit can be used only once to temporarily repair a single tire. If the sealant has been used and needs to be replaced, purchase a new bottle at any authorized Toyota dealer or repairer, or another duly qualified and equipped professional. The compressor is reusable.
- The sealant can be used when the outside temperature is from -30°C (-22°F) to 60°C (140°F).
- The repair kit is exclusively designed for size and type of tires originally installed on your vehicle. Do not use it for tires that a different size than the original ones, or for any other purposes.
- The sealant has a limited lifespan. The expiry date is marked on the bottle. The bottle of sealant should be replaced with a new bottle before the expiry date. Contact any authorized Toyota dealer or repairer, or another duly qualified and equipped professional for replacement.
- If the sealant gets on your clothes, it may stain.
- If the sealant adheres to a wheel or the surface of the vehicle body, the stain may not be removable if it is not cleaned at once. Immediately wipe away the sealant with a wet cloth.
- During operation of the repair kit, a loud operation noise is produced. This does not indicate a malfunction.
- Do not use to check or to adjust the tire pressure.

 CAUTION

■ **Do not drive the vehicle with a flat tire**

Do not continue driving with a flat tire.

Driving even a short distance with a flat tire can damage the tire and the wheel beyond repair.

Driving with a flat tire may cause a circumferential groove on the side wall. In such a case, the tire may explode when using a repair kit.

■ **Caution while driving**

- Store the repair kit in the luggage room.
Injuries may result in the event of an accident or sudden braking.
- The repair kit is exclusively only for your vehicle.
Do not use repair kit on other vehicles, which could lead to an accident causing death or serious injury.
- Do not use repair kit for tires that are different size than the original ones, or for any other purpose. If the tires have not been completely repaired, it could lead to an accident causing death or serious injury.

■ **Precautions for use of the sealant**

- Ingesting the sealant is hazardous to your health. If you ingest sealant, consume as much water as possible, and then immediately consult a doctor.
- If sealant gets in eyes or adheres to skin, immediately wash it off with water. If discomfort persists, consult a doctor.

■ **When fixing the flat tire**

- Stop your vehicle in a safe and flat area.
- Do not touch the wheels or the area around the brakes immediately after the vehicle has been driven.
After the vehicle has been driven, the wheels and the area around the brakes may be extremely hot. Touching these areas with hands, feet or other body parts may result in burns.

 CAUTION**■ When fixing the flat tire**

- To avoid risk of burst or severe leakage, do not drop or damage the bottle. Visually inspect the bottle before use. Do not use a bottle with shock, crack, scratch, leakage or any other damage. In such case, immediately replace.
- Connect the valve and hose securely with the tire installed on the vehicle. If the hose is not properly connected to the valve, air leakage may occur as sealant may be sprayed out.
- If the hose comes off the valve while inflating the tire, there is a risk that the hose will move abruptly due to air pressure.
- After inflation of the tire has completed, the sealant may splatter when the hose is disconnected or some air is let out of the tire.
- Follow the operation procedure to repair the tire. If the procedures not followed, the sealant may spray out.
- Keep back from the tire while it is being repaired, as there is a chance of it bursting while the repair operation is being performed. If you notice any cracks or deformation of the tire, turn off the compressor switch and stop the repair operation immediately.
- The repair kit may overheat if operated for a long period of time. Do not operate the repair kit continuously for more than 40 minutes.
- Parts of the repair kit become hot during operation. Be careful when handling the repair kit during and after operation. Do not touch the metal part around the connecting area between the bottle and compressor. It will be extremely hot.
- Do not attach the vehicle speed warning sticker to an area other than the one indicated. If the sticker is attached to an area where an SRS airbag is located, such as the pad of the steering wheel, it may prevent the SRS airbag from operating properly.

 CAUTION

■ **Driving to spread the liquid sealant evenly**

Observe the following precautions to reduce the risk of accidents. Failing to do so may result in a loss of vehicle control and cause death or serious injury.

- Drive the vehicle carefully at a low speed. Be especially careful when turning and cornering.
- If the vehicle does not drive straight or you feel a pull through the steering wheel, stop the vehicle and check the following.
 - Tire condition. The tire may have separated from the wheel.
 - Tire inflation pressure. If the tire inflation pressure is 130 kPa (1.3 kgf/cm² or bar, 19 psi) or less, the tire may be severely damaged.

 NOTICE

■ **When performing an emergency repair**

- A tire should only be repaired with the emergency tire puncture repair kit if the damage is caused by a sharp object such as nail or screw passing through the tire tread.
Do not remove the sharp object from the tire. Removing the object may widen the opening and disenable emergency repair with the repair kit.
- The repair kit is not waterproof. Make sure that the repair kit is not exposed to water, such as when it is being used in the rain.
- Do not put the repair kit directly onto dusty ground such as sand at the side of the road. If the repair kit vacuums up dust etc., a malfunction may occur.

 NOTICE**■ Precautions for the emergency tire puncture repair kit**

- The repair kit power source should be 12 V DC suitable for vehicle use. Do not connect the repair kit to any other source.
- If gasoline splatters on the repair kit, the repair kit may deteriorate. Take care not to allow gasoline to contact it.
- Place the repair kit in a storage to prevent it from being exposed to dirt or water.
- Store the repair kit in the luggage room out of reach of children.
- Do not disassemble or modify the repair kit. Do not subject parts such as the air pressure indicator to impacts. This may cause a malfunction.

■ To avoid damage to the tire pressure warning valves and transmitters (vehicles with the tire pressure warning system)

When a tire is repaired with liquid sealants, the tire pressure warning valve and transmitter may not operate properly. If a liquid sealant is used, contact any authorized Toyota dealer or repairer, or another duly qualified and equipped professional or other qualified service shop as soon as possible. After use of liquid sealant, make sure to replace the tire pressure warning valve and transmitter when repairing or replacing the tire. (→P. 432)

5-2. Steps to take in an emergency If the engine will not start

If the engine still does not start after following the correct starting procedure (→P. 198, 202) or releasing the steering lock (→P. 200, 205), confirm the following points.

■ **The engine will not start even if you are carrying the correct key**

One of the following may be the cause of the problem.

- There may not be sufficient fuel in the vehicle's tank.
Refuel the vehicle.
- The engine may be flooded. (gasoline engine)
Try to restart the engine once more following correct starting procedures. (→P. 198, 202)
- There may be a malfunction in the engine immobilizer system.
(→P. 124)

■ **The starter motor turns over slowly, the personal/interior lights and headlights are dim, or the horn does not sound or sounds at a low volume**

One of the following may be the cause of the problem.

- The battery may be discharged. (→P. 565)
- The battery terminal connections may be loose or corroded.

■ **The starter motor does not turn over (vehicles with smart entry & start system)**

The engine starting system may be malfunctioning due to an electrical problem such as an open circuit or a blown fuse. However, an interim measure is available to start the engine.
(→P. 558)

■ **The starter motor does not turn over, the personal/interior lights and headlights do not turn on, or the horn does not sound**

One of the following may be the cause of the problem.

- One or both of the battery terminals may be disconnected.
- The battery may be discharged. (→P. 565)
- There may be a malfunction in the steering lock system. (vehicles with smart entry & start system)

Contact any authorized Toyota dealer or repairer, or another duly qualified and equipped professional, if the problem cannot be repaired, or if repair procedures are unknown.

Emergency start function (vehicles with smart entry & start system)

When the engine does not start, the following steps can be used as an interim measure to start the engine if the “ENGINE START STOP” switch is functioning normally.

▶ Vehicles with a Multidrive

STEP 1 Set the parking brake.

STEP 2 Put the shift lever in “P”.

STEP 3 Set the “ENGINE START STOP” switch to ACCESSORY mode.

STEP 4 Press and hold the “ENGINE START STOP” switch about 15 seconds while depressing the brake pedal firmly.

▶ Vehicles with a manual transmission

STEP 1 Set the parking brake.

STEP 2 Put the shift lever in “N”.

STEP 3 Set the “ENGINE START STOP” switch to ACCESSORY mode.

STEP 4 Press and hold the “ENGINE START STOP” switch about 15 seconds while depressing the brake pedal and clutch pedal firmly.

Even if the engine can be started using the above steps, the system may be malfunctioning. Have the vehicle checked by any authorized Toyota dealer or repairer, or another duty qualified and equipped professional.

5-2. Steps to take in an emergency

If the shift lever cannot be shifted from "P" (vehicles with a Multidrive)

For vehicles with a Multidrive: If the shift lever cannot be shifted with your foot on the brake, there may be a problem with the shift lock system (a system to prevent accidental operation of the shift lever). Have the vehicle inspected by any authorized Toyota dealer or repairer, or another duly qualified and equipped professional, immediately.

The following steps may be used as an emergency measure to ensure that the shift lever can be shifted.

STEP 1 Set the parking brake.

STEP 2 Vehicles without smart entry & start system: Turn the engine switch to the "ACC" position.

Vehicles with smart entry & start system: Turn the "ENGINE START STOP" switch to ACCESSORY mode.

STEP 3 Depress the brake pedal.

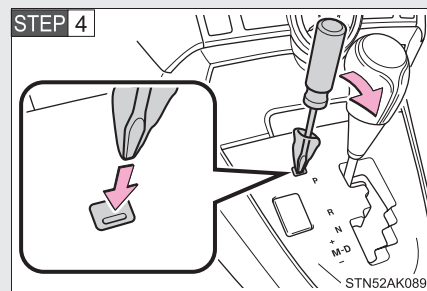

Pry the cover up with a flat-head screwdriver or equivalent tool.

To prevent damage to the cover, cover the tip of the screwdriver with a rag.

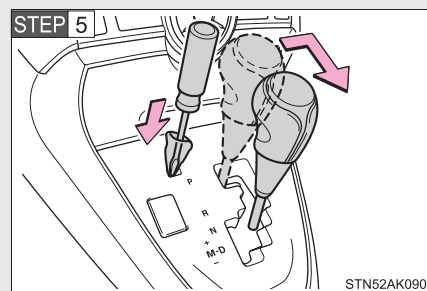

Press the shift lock override button.

The shift lever can be shifted while the button is pressed.

5-2. Steps to take in an emergency If you lose your keys

New genuine Toyota keys can be made by any authorized Toyota dealer or repairer, or another duly qualified and equipped professional. For vehicles without smart entry & start system, bring a key and the key number stamped on the key number plate. For vehicles with smart entry & start system, bring the other keys and the key number stamped on your key number plate.

5-2. Steps to take in an emergency If you cannot operate the back door opener

If the back door opener does not operate, there may be a problem with the back door opener system. Have the vehicle inspected by any authorized Toyota dealer or repairer, or another duly qualified and equipped professional immediately.

The following steps may be used as an emergency measure to ensure that the back door can be opened from the inside.

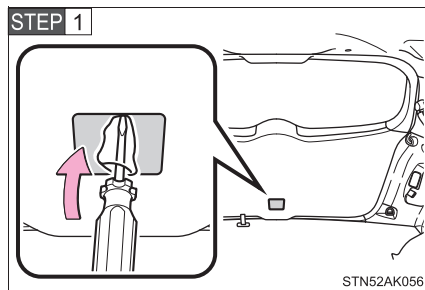

Remove the cover on the back door trim.

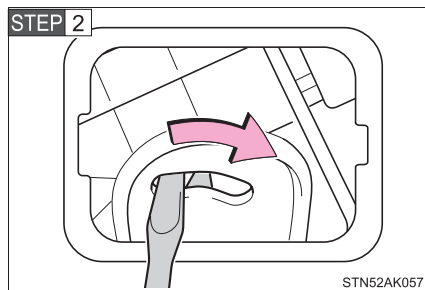

Push the lever with the back door motor, and open the back door.

5-2. Steps to take in an emergency

If the electronic key does not operate properly (vehicles with smart entry & start system)

If communication between the electronic key and vehicle is interrupted (→P. 63) or the electronic key cannot be used because the battery is depleted, the smart entry & start system and wireless remote control cannot be used. In such cases, the doors can be opened or the engine can be started by following the procedure below.

Locking and unlocking the doors and key linked functions

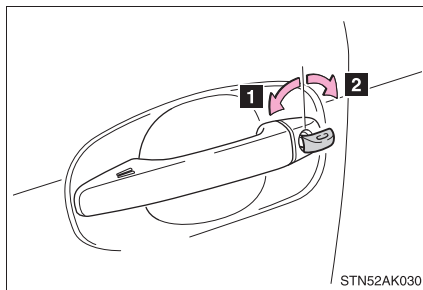

Using the mechanical key (→P. 39) in order to perform the following operations:

- 1 Locks all doors
- 2 Unlocks all doors

Vehicles with alarm: An alarm will sound if the alarm is set.
(→P. 136)

Starting the engine

STEP 1 Vehicles with a Multidrive: Shift the shift lever to “P” and apply the brakes.

Vehicles with a manual transmission: Shift the shift lever to “N” and depress the clutch pedal.

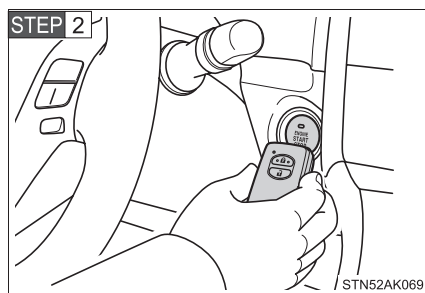

Touch the Toyota emblem side of the electronic key to the “ENGINE START STOP” switch.

An alarm will sound to indicate that the start function cannot detect the electronic key that is touched to the “ENGINE START STOP” switch if any of the doors is opened and closed while the key is touched to the switch.

STEP 3 Press the “ENGINE START STOP” switch within 10 seconds after the buzzer sounds, keeping the brake pedal (Multidrive) or clutch pedal (manual transmission) depressed.

In the event that the “ENGINE START STOP” switch still cannot be operated, contact any authorized Toyota dealer or repairer, or another duly qualified and equipped professional.

■ **Stopping the engine**

Shift the shift lever to “P” (Multidrive) or “N” (manual transmission) and press the “ENGINE START STOP” switch as you normally do when stopping the engine.

■ **Replacing the key battery**

As the above procedure is the temporary measure, it is recommended that the electronic key battery be replaced immediately when the battery depletes. (→P. 453)

■ **Alarm (if equipped)**

Using the mechanical key to lock the doors will not set the alarm system. If a door is unlocked using the mechanical key when the alarm system is set, the alarm may be triggered. (→P. 136)

■ **Changing “ENGINE START STOP” switch modes**

▶ **Multidrive**

Within 10 seconds of the buzzer sounding, release the brake pedal and press the “ENGINE START STOP” switch.

The engine does not start and modes will be changed each time the switch is pressed. (→P. 204)

▶ **Manual transmission**

Within 10 seconds of the buzzer sounding, release the clutch pedal and press the “ENGINE START STOP” switch.

The engine does not start and modes will be changed each time the switch is pressed. (→P. 204)

5-2. Steps to take in an emergency If the vehicle battery is discharged

The following procedures may be used to start the engine if the vehicle's battery is discharged.

You can call any authorized Toyota dealer or repairer, or another duly qualified and equipped professional.

If you have a set of jumper (or booster) cables and a second vehicle with a 12-volt battery, you can jump start your Toyota following the steps below.

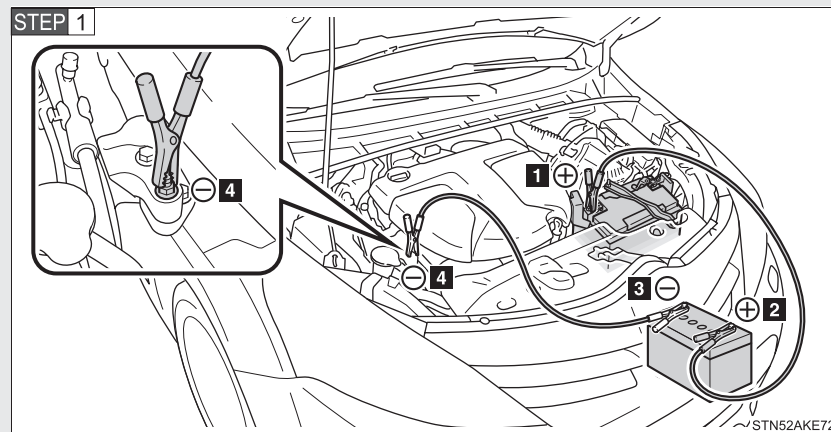

Connecting the jumper cables.

- 1** Positive (+) battery terminal on your vehicle
- 2** Positive (+) battery terminal on the second vehicle
- 3** Negative (-) battery terminal on the second vehicle
- 4** Connect the jumper cable to ground on your vehicle as shown in the illustration.

STEP 2 Start the engine of the second vehicle. Increase the engine speed slightly and maintain at that level for approximately 5 minutes to recharge the battery of your vehicle.

STEP 3 Vehicles with smart entry & start system: Open and close any of the doors with the "ENGINE START STOP" switch off.

5-2. Steps to take in an emergency

STEP 4 Vehicles without smart entry & start system: Maintain the engine speed of the second vehicle and turn the engine switch to the “ON” position, then start the vehicle’s engine.
Vehicles with smart entry & start system: Maintain the engine speed of the second vehicle and turn the “ENGINE START STOP” switch to IGNITION ON mode, then start the vehicle’s engine.

STEP 5 Once the vehicle’s engine has started, remove the jumper cables in the exact reverse order in which they were connected.

Once the engine starts, have the vehicle checked at any authorized Toyota dealer or repairer, or another duly qualified and equipped professional, as soon as possible.

■ Starting the engine when the battery is discharged (vehicles with a Multidrive)

The engine cannot be started by push-starting.

■ Avoiding a discharged battery

- Turn off the headlights and the audio system while the engine is turned off.
- Turn off any unnecessary electrical components when the vehicle is running at a low speed for an extended period, such as in heavy traffic, etc.

■ Charging the battery

The electricity stored in the battery will discharge gradually even when the vehicle is not in use, due to natural discharge and the draining effects of certain electrical appliances. If the vehicle is left for a long time, the battery may discharge, and the engine may be unable to start. (The battery recharges automatically during driving.)

■ When the battery is removed or discharged (vehicles with alarm)

Make sure that the key is not inside the vehicle when recharging or replacing the battery. The key may be locked in the vehicle if the alarm is activated. (→P. 139)

⚠ CAUTION**■ Avoiding battery fires or explosions**

Observe the following precautions to prevent accidentally igniting the flammable gas that may be emitted from the battery.

- Make sure the jumper cable is connected to the correct terminal and that it is not unintentionally in contact with any part other than the intended terminal.
- Do not allow the jumper cables to come into contact with the “+” and “-” terminals.
- Do not allow open flame or use matches, cigarette lighters or smoke near the battery.

■ Battery precautions

The battery contains poisonous and corrosive acidic electrolyte, while related parts contain lead and lead compounds. Observe the following precautions when handling the battery.

- When working with the battery, always wear safety glasses and take care not to allow any battery fluids (acid) to come into contact with skin, clothing or the vehicle body.
- Do not lean over the battery.
- In the event that battery fluid comes into contact with the skin or eyes, immediately wash the affected area with water and seek medical attention. Place a wet sponge or cloth over the affected area until medical attention can be received.
- Always wash your hands after handling the battery support, terminals, and other battery-related parts.
- Do not allow children near the battery.

5-2. Steps to take in an emergency

NOTICE

■ **To prevent damaging the vehicle (vehicles with a manual transmission)**

Do not pull- or push-start the vehicle, because the catalytic converter may overheat and become a fire hazard.

■ **When handling jumper cables**

Be careful that the jumper cables do not become tangled in the cooling fan or any of the belts when connecting or disconnecting them.

5-2. Steps to take in an emergency If your vehicle overheats

The following may indicate that your vehicle is overheating.

- The high engine coolant temperature warning light (→P. 500) comes on or flashes, or a loss of engine power is experienced. (For example, the vehicle speed does not increase.)
- Steam comes out from under the hood.

Correction procedures

STEP 1 Stop the vehicle in a safe place and turn off the air conditioning system, and then stop the engine.

STEP 2 If you see steam:

Carefully lift the hood after the steam subsides.

If you do not see steam:

Carefully lift the hood.

STEP 3 After the engine has cooled down sufficiently, inspect the hoses and radiator core (radiator) for any leaks.

► Gasoline engine

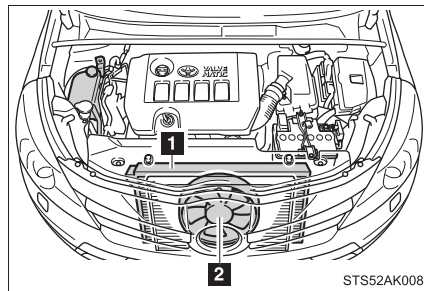

1 Radiator

2 Cooling fan

If a large amount of coolant leaks, immediately contact any authorized Toyota dealer or repairer, or another duly qualified and equipped professional.

5-2. Steps to take in an emergency

► Diesel engine

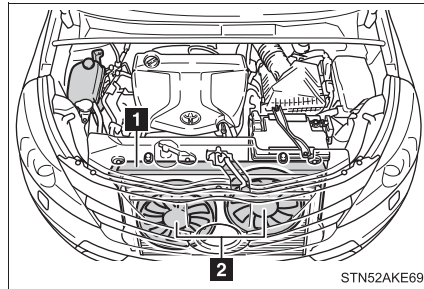

1 Radiator

2 Cooling fans

If a large amount of coolant leaks, immediately contact any authorized Toyota dealer or repairer, or another duly qualified and equipped professional.

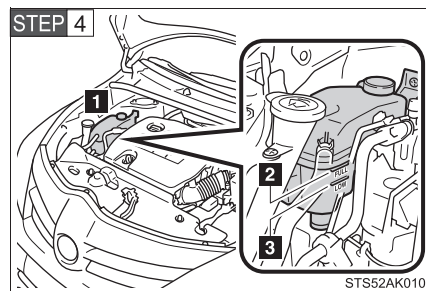

The coolant level is satisfactory if it is between the "FULL" and "LOW" lines on the reservoir.

1 Reservoir

2 "FULL"

3 "LOW"

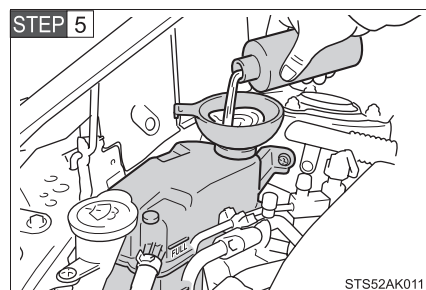

Add coolant if necessary.

Water can be used in an emergency if coolant is unavailable.

STEP 6 Start the engine and turn the air conditioning system on to check that the radiator cooling fan operates and to check for coolant leaks from the radiator or hoses.

The fan operates when the air conditioning system is turned on immediately after a cold start. Confirm that the fan is operating by checking the fan sound and air flow. If it is difficult to check these, turn the air conditioning system on and off repeatedly. (The fan may not operate in freezing temperatures.)

STEP 7 If the fan is not operating:

Stop the engine immediately and contact any authorized Toyota dealer or repairer, or another duly qualified and equipped professional.

If the fan is operating:

Have the vehicle inspected at the nearest any authorized Toyota dealer or repairer, or another duly qualified and equipped professional.

 **CAUTION****■ To prevent an accident or injury when inspecting under the hood of your vehicle**

- If steam is seen coming from under the hood, do not open the hood until the steam has subsided. The engine compartment may be very hot, causing serious injuries such as burns.
- Keep hands and clothing (especially a tie, a scarf or a muffler) away from the fans and belts. Failure to do so may cause the hands or clothing to be caught, resulting in serious injury.
- Do not loosen the coolant reservoir cap while the engine and radiator are hot.
Serious injury, such as burns, may result from hot coolant and steam released under pressure.

 **NOTICE****■ When adding engine coolant**

Wait until the engine has cooled down before adding engine coolant. When adding coolant, do so slowly. Adding cool coolant to a hot engine too quickly can cause damage to the engine.

■ To prevent damage to the cooling system

Observe the following precautions:

- Avoid contaminating the coolant with foreign matter (such as sand or dust etc.).
- Do not use any coolant additive.

5-2. Steps to take in an emergency If the vehicle becomes stuck

Carry out the following procedures if the tires spin or the vehicle becomes stuck in mud, dirt or snow:

- STEP 1** Stop the engine. Set the parking brake and shift the shift lever in “P” (Multidrive) or “N” (manual transmission).
- STEP 2** Remove the mud, snow or sand from around the front wheels.
- STEP 3** Place wood, stones or some other material under the front wheels to help provide traction.
- STEP 4** Restart the engine.
- STEP 5** Shift the shift lever to the “D” or “R” position (Multidrive) or “1” or “R” position (manual transmission) and release the parking brake. Then, while exercising caution, depress the accelerator pedal.

■ When it is difficult to free the vehicle

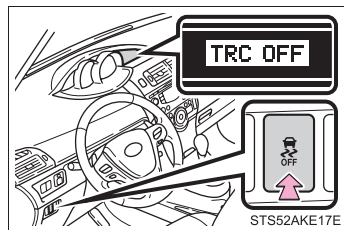

Press the button to turn off TRC.

■ Emergency hook

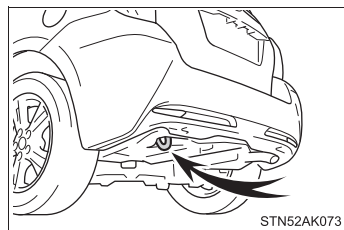

When your vehicle becomes stuck and cannot move, the emergency hook is used for another vehicle to pull your vehicle out in an emergency.

Your vehicle is not designed to tow another vehicle.

Do not use the right rear hook. It is not designed for towing.

 CAUTION

■ **When attempting to free a stuck vehicle**

If you choose to push the vehicle back and forth to free it, make sure the surrounding area is clear to avoid striking other vehicles, objects or people. The vehicle may also lunge forward or lunge back suddenly as it becomes free. Use extreme caution.

■ **When shifting the shift lever**

On vehicles with a Multidrive, be careful not to shift the shift lever with the accelerator pedal depressed.

This may lead to unexpected rapid acceleration of the vehicle that may cause an accident resulting in death or serious injury.

 NOTICE

■ **To avoid damage to the transmission and other components**

- Avoid spinning the front wheels and depressing the accelerator pedal more than necessary.
- If the vehicle remains stuck even after these procedures are performed, the vehicle may require towing to be freed.

5-2. Steps to take in an emergency

If your vehicle has to be stopped in an emergency

Only in an emergency, such as if it becomes impossible to stop the vehicle in the normal way, stop the vehicle using the following procedure:

STEP 1 Steadily step on the brake pedal with both feet and firmly depress it.

Do not pump the brake pedal repeatedly as this will increase the effort required to slow the vehicle.

STEP 2 Shift the shift lever to “N”.

► If the shift lever is shifted to “N”

STEP 3 After slowing down, stop the vehicle in a safe place by the road.

STEP 4 Stop the engine.

► If the shift lever cannot be shifted to “N”

STEP 3 Keep depressing the brake pedal with both feet to reduce vehicle speed as much as possible.

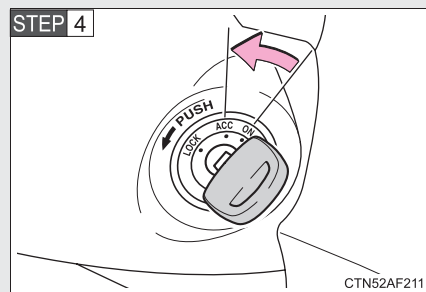

Vehicles without smart entry & start system: Stop the engine by turning the engine switch to the “ACC” position.

STEP 4

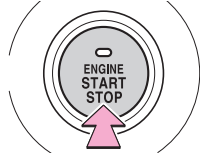

Press and hold for 2 seconds or more, or press briefly 3 times or more

CTY52AD216

Vehicles with smart entry & start system: To stop the engine, press and hold the “ENGINE START STOP” switch for 2 consecutive seconds or more, or press it briefly 3 times or more in succession.

STEP 5 Stop the vehicle in a safe place by the road.

⚠ CAUTION

■ **If the engine has to be turned off while driving**

- Power assist for the brakes and steering wheel will be lost, making the brake pedal harder to depress and the steering wheel heavier to turn. Decelerate as much as possible before turning off the engine.
- Vehicles without smart entry & start system: Never attempt to remove the key, as doing so will lock the steering wheel.

5-2. Steps to take in an emergency

576

6-1. Specifications

Maintenance data
(fuel, oil level, etc.)..... 578
Fuel information 599

6-2. Customization

Customizable features 602

6-3. Initialization

Items to initialize 606

6-1. Specifications

Maintenance data (fuel, oil level, etc.)

Dimensions and weights		
Overall length		4440 mm (174.8 in.)
Overall width		1790 mm (70.5 in.)
Overall height *1	205/60R16 tires	<ul style="list-style-type: none"> ▶ Without roof rail 1620 mm (63.8 in.) 1630 mm (64.2 in.) *2, 3 ▶ With roof rail 1660 mm (65.4 in.) 1670 mm (65.7 in.) *2, 3
	215/55R17 tires	<ul style="list-style-type: none"> ▶ Without roof rail 1630 mm (64.2 in.) 1640 mm (64.6 in.) *2 ▶ With roof rail 1670 mm (65.7 in.) 1680 mm (66.1 in.) *2
Wheelbase		2780 mm (109.4 in.)
Tread	Front	1535 mm (60.4 in.)
	Rear	1545 mm (60.8 in.)
Gross vehicle mass		1935 kg (4266 lb.) *3, 4, 5
		2125 kg (4686 lb.) *4, 5
		2060 kg (4542 lb.) *3, 6
		2260 kg (4983 lb.) *6
Maximum permissible axle capacity	Front	1220 kg (2690 lb.) *4, 5 1260 kg (2778 lb.) *6
	Rear	1180 kg (2601 lb.)
Drawbar load		55 kg (121 lb.)
Towing capacity	With brake	1300 kg (2866 lb.)
	Without brake	450 kg (992 lb.)
Maximum permissible mass for towing hitch/bracket*3		20 kg (44 lb.)

- *1: Unladen vehicles
- *2: Vehicles with rough road area spec
- *3: Vehicle category N1 models
- *4: 1ZR-FAE engine
- *5: 2ZR-FAE engine
- *6: 1WW engine

To distinguish the vehicle category, ask any authorized Toyota dealer or repairer, or another duly qualified and equipped professional.

Vehicle identification

■ Vehicle identification number

The vehicle identification number (VIN) is the legal identifier for your vehicle. This is the primary identification number for your Toyota. It is used in registering the ownership of your vehicle.

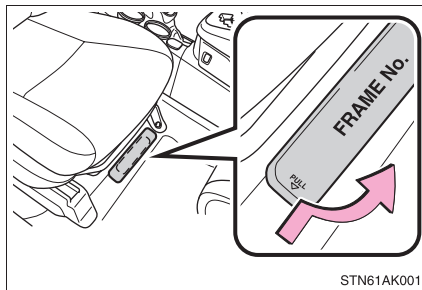

This number is stamped under the front right seat.

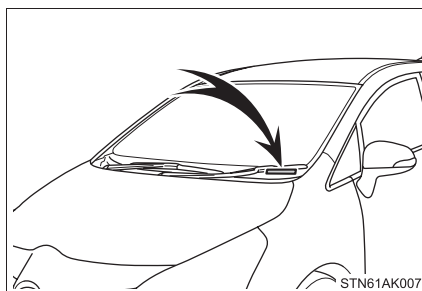

Right-hand drive vehicles: This number is stamped on the top left of the instrument panel.

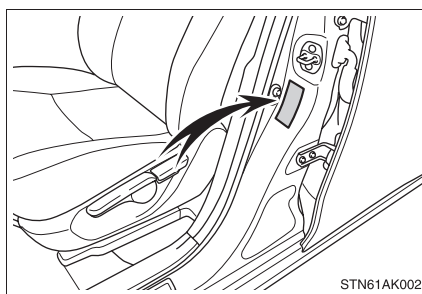

This number is also on the manufacturer's label on the left-hand side center pillar.

■ **Engine number**

The engine number is stamped on the engine block as shown.

▶ **Gasoline engine**

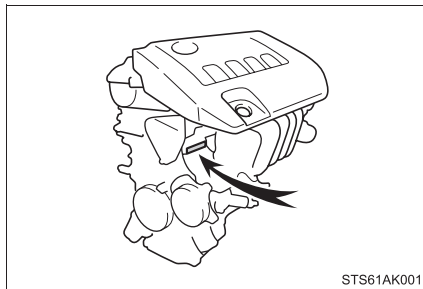

▶ **Diesel engine**

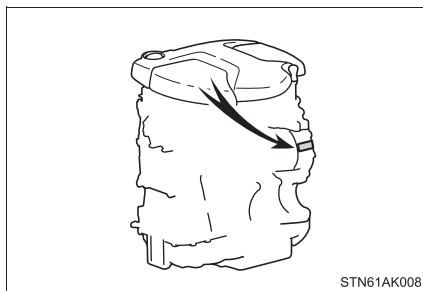

► Diesel engine

Model	1WW
Type	4-cylinder in line, 4-cycle, diesel (with turbo charger)
Bore and stroke	78.0 × 83.6 mm (3.07 × 3.29 in.)
Displacement	1598 cm ³ (97.52 cu. in.)
Valve clearance (Engine cold)	Automatic adjustment
Drive belt tension	Automatic adjustment

Fuel

► Gasoline engine

Fuel type	EU area: Unleaded gasoline conforming to European standard EN228 only Except EU area: Unleaded gasoline only
Research octane number	95 or higher
Fuel tank capacity (Reference)	60 L (15.9 gal., 13.2 Imp.gal.)

► Diesel engine

Fuel type	Diesel fuel conforming to European standard EN590 is an ultra low sulphur diesel (max 10 ppm).
Cetane number	48 or higher
Fuel tank capacity (Reference)	55 L (14.5 gal., 12.1 Imp.gal.)

Lubrication system

▶ Gasoline engine

Oil capacity (Drain and refill - reference*)	
With filter	4.2 L (4.4 qt., 3.7 Imp.qt.)
Without filter	3.9 L (4.1 qt., 3.4 Imp.qt.)

*: The engine oil capacity is a reference quantity to be used when changing the engine oil. Warm up and turn off the engine, wait more than 5 minutes, and check the oil level on the dipstick.

■ Engine oil selection

▶ EU area

“Toyota Genuine Motor Oil” is used in your Toyota vehicle. Toyota recommends the use of approved “Toyota Genuine Motor Oil”. Another motor oil of matching quality can also be used.

Oil grade:

0W-20, 5W-30 and 10W-30:

API grade SL “Energy-Conserving”, SM “Energy-Conserving” or SN “Resource-Conserving”; or ILSAC multigrade engine oil

15W-40:

API grade SL, SM or SN multigrade engine oil

Recommended viscosity (SAE):

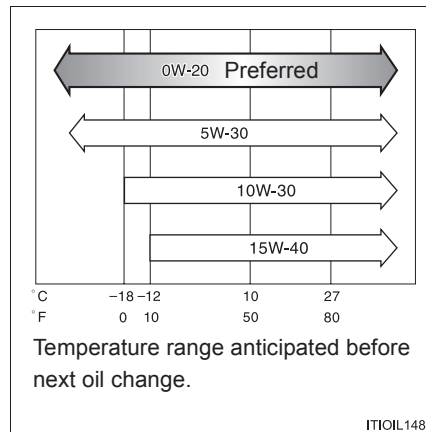

SAE 0W-20 is filled into your Toyota vehicle at manufacturing, and the best choice for good fuel economy and good starting in cold weather.

If SAE 0W-20 oil is not available, SAE 5W-30 oil may be used. However, it should be replaced with SAE 0W-20 at the next oil change.

If you use SAE 10W-30 or a higher viscosity engine oil in extremely low temperatures, the engine may become difficult to start, so SAE 0W-20 or 5W-30 engine oil is recommended.

Oil viscosity (0W-20 is explained here as an example):

- The 0W in 0W-20 indicates the characteristic of the oil which allows cold startability. Oils with a lower value before the W allow for easier starting of the engine in cold weather.
- The 20 in 0W-20 indicates the viscosity characteristic of the oil when the oil is at high temperature. An oil with a higher viscosity (one with a higher value) may be better suited if the vehicle is operated at high speeds, or under extreme load conditions.

6-1. Specifications

How to read oil container labels:

Either or both API registered marks are added to some oil containers to help you select the oil you should use.

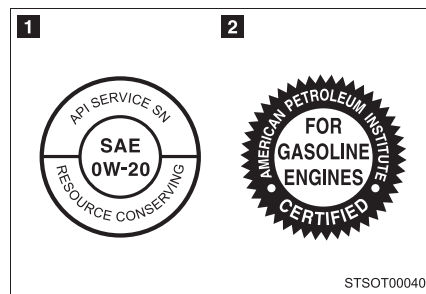

1 API Service Symbol

Top portion: “API SERVICE SN” means the oil quality designation by American Petroleum Institute (API).

Center portion: “SAE 0W-20” means the SAE viscosity grade.

Lower portion: “Resource-Conserving” means that the oil has fuel-saving and environmental protection capabilities.

2 ILSAC Certification Mark

The International Lubricant Specification Advisory Committee (ILSAC) Certification Mark is displayed on the front of the container.

► Except EU area

“Toyota Genuine Motor Oil” is used in your Toyota vehicle. Use Toyota approved “Toyota Genuine Motor Oil” or equivalent to satisfy the following grade and viscosity.

Oil grade:

0W-20, 5W-20, 5W-30 and 10W-30:

API grade SL “Energy-Conserving”, SM “Energy-Conserving” or SN “Resource-Conserving”; or ILSAC multigrade engine oil

15W-40 and 20W-50:

API grade SL, SM or SN multigrade engine oil

Recommended viscosity (SAE):

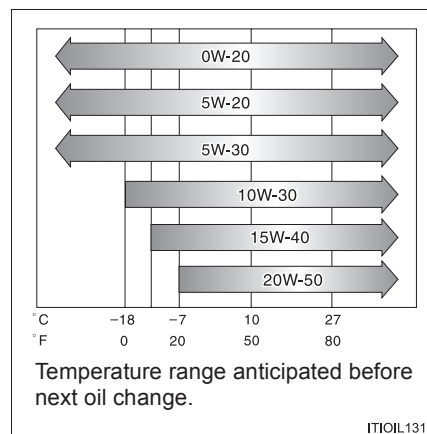

If you use SAE 10W-30 or a higher viscosity engine oil in extremely low temperatures, the engine may become difficult to start, so SAE 0W-20, 5W-20 or 5W-30 engine oil is recommended.

Oil viscosity (0W-20 is explained here as an example):

- The 0W in 0W-20 indicates the characteristic of the oil which allows cold startability. Oils with a lower value before the W allow for easier starting of the engine in cold weather.
- The 20 in 0W-20 indicates the viscosity characteristic of the oil when the oil is at high temperature. An oil with a higher viscosity (one with a higher value) may be better suited if the vehicle is operated at high speeds, or under extreme load conditions.

6-1. Specifications

How to read oil container labels:

Either or both API registered marks are added to some oil containers to help you select the oil you should use.

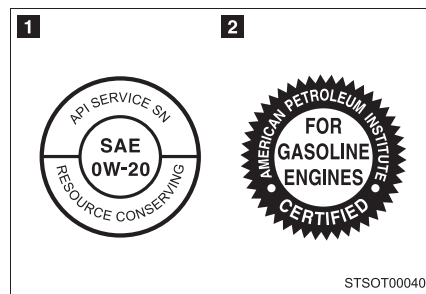

1 API Service Symbol

Top portion: “API SERVICE SN” means the oil quality designation by American Petroleum Institute (API).

Center portion: “SAE 0W-20” means the SAE viscosity grade.

Lower portion: “Resource-Conserving” means that the oil has fuel-saving and environmental protection capabilities.

2 ILSAC Certification Mark

The International Lubricant Specification Advisory Committee (ILSAC) Certification Mark is displayed on the front of the container.

► Diesel engine

Oil capacity (Drain and refill - reference*)	
With filter	5.2 L (5.5 qt., 4.6 Imp.qt.)

*: The engine oil capacity is a reference quantity to be used when changing the engine oil. Warm up and turn off the engine, wait more than 5 minutes, and check the oil level on the dipstick.

Toyota recommends the use of approved “Toyota Genuine Motor Oil 5W-30 Premium Fuel Economy for 1WW/2WW engines”. Contact any authorized Toyota dealer or repairer, or another duly qualified and equipped professional, for usage of any other approved engine oil of matching quality.

 NOTICE

■ **To prevent damage to the engine**

- Use of engine oils other than “Toyota Genuine Motor Oil 5W-30 Premium Fuel Economy for 1WW/2WW engines” or any other approved engine oil, may cause damage to the engine.
- If the approved oils are not available, up to 1 liter of the following oils may be used: ACEA C3 oils.
Confirm that the viscosity grade is SAE 0W-40, 0W-30, 5W-40 or 5W-30.
Viscosities other than these, may damage the engine.

Cooling system

Capacity (Reference)	1ZR-FAE engine	<ul style="list-style-type: none"> ▶ For Greece and Cyprus 6.3 L (6.7 qt., 5.5 Imp.qt.) ▶ Others 5.6 L (5.9 qt., 4.9 Imp.qt.)
	2ZR-FAE engine	<ul style="list-style-type: none"> ▶ Manual transmission For Greece and Cyprus: 6.3 L (6.7 qt., 5.5 Imp.qt.) Others: 5.6 L (5.9 qt., 4.9 Imp.qt.) ▶ Multidrive 6.2 L (6.6 qt., 5.5 Imp.qt.)
	1WW engine	<ul style="list-style-type: none"> ▶ With power heater 7.3 L (7.7 qt., 6.4 Imp.qt.) ▶ Without power heater 7.0 L (7.4 qt., 6.2 Imp.qt.)
Coolant type	1ZR-FAE and 2ZR-FAE engines	<p>Use either of the following.</p> <ul style="list-style-type: none"> • “Toyota Super Long Life Coolant” • Similar high-quality ethylene glycol-based non-silicate, non amine, non-nitrite, and non-borate coolant with long-life hybrid organic acid technology <p>Do not use plain water alone.</p>
	1WW engine	<p>“Toyota Genuine Premium Long Life Coolant 1WW/2WW” or equivalent. “Toyota Genuine Premium Long Life Coolant 1WW/2WW” concentrated product always needs to be mixed as 50% coolant and 50% deionized water. Do not use plain water alone. Contact any authorized Toyota dealer or repairer, or another duly qualified and equipped professional, for usage of any other approved engine coolant of matching quality.</p>

Ignition system (gasoline engine only)

Spark plug	
Make	DENSO SC20HR11
Gap	1.1 mm (0.043 in.)

 NOTICE**■ Iridium-tipped spark plugs**

Use only iridium-tipped spark plugs. Do not adjust the spark plug gap.

Electrical system

▶ Batteries with vent plugs

Battery	
Specific gravity reading at 20°C (68°F):	1.250 — 1.290 Fully charged 1.160 — 1.200 Half charged 1.060 — 1.100 Discharged
Charging rates	
Quick charge	15 A max.
Slow charge	5 A max.

▶ Batteries without vent plugs

Battery	
Open voltage at 20°C (68°F):	12.6 — 12.8 V Fully charged 12.2 — 12.4 V Half charged 11.8 — 12.0 V Discharged (Voltage is checked 20 minutes after the engine and all the lights are turned off.)
Charging rates	5 A max.

Multidrive (2ZR-FAE engine only)

Fluid capacity (Reference)	7.6 L (8.0 qt., 6.7 Imp.qt.)
Fluid type	Toyota Genuine CVT Fluid FE

The fluid capacity is a reference quantity. If replacement is necessary, contact any authorized Toyota dealer or repairer, or another duly qualified and equipped professional.

 **NOTICE**

■ **Multidrive fluid type**

Using Multidrive fluid other than “Toyota Genuine CVT Fluid FE” may cause deterioration in shift quality, locking up of your transmission accompanied by vibration, and ultimately damage to the vehicle’s transmission.

Manual transmission

Gear oil capacity (Reference)	Gasoline engine	2.4 L (2.5 qt., 2.1 Imp.qt.)
	Diesel engine	2.1 L (2.2 qt., 1.8 Imp.qt.)
Gear oil type		Use either of the following: <ul style="list-style-type: none"> • “TOYOTA Genuine Manual Transmission Gear Oil LV” • Other gear oil that meets API GL-4 and SAE 75W specifications

 NOTICE**Manual transmission gear oil**

Please be aware that depending on the particular characteristics of the gear oil used or the operating conditions, idle sound, shift feeling and/or fuel efficiency may be different or affected. Toyota recommends to use “TOYOTA Genuine Manual Transmission Gear Oil LV” to achieve optimal performance.

Clutch

Pedal free play	5 — 15 mm (0.2 — 0.6 in.)
Fluid type	SAE J1703 or FMVSS No. 116 DOT 3 or SAE J1704 or FMVSS No. 116 DOT 4

6-1. Specifications

Brakes

Pedal clearance* ¹	
▶ Left-hand drive vehicles	75 mm (2.95 in.) Min.
▶ Right-hand drive vehicles	70 mm (2.76 in.) Min.
Pedal free play	1 — 6 mm (0.04 — 0.24 in.)
Parking brake lever travel* ²	6 — 9 clicks
Fluid type	SAE J1703 or FMVSS No. 116 DOT 3 or SAE J1704 or FMVSS No. 116 DOT 4

*1: Minimum pedal clearance when depressed with a force of 294 N (30 kgf, 66 lbf) while the engine is running

*2: Parking brake lever travel when pulled up with a force of 200 N (20 kgf, 45 lbf)

Steering

Free play	Less than 30 mm (1.2 in.)
-----------	---------------------------

Tires and wheels

▶ 16 inch tires

Tire size	205/60R16 92V, T145/70D17 106M (compact spare)		
▶ Gasoline engine Tire inflation pressure (Recommended cold tire inflation pressure)	Vehicle speed	Front wheel kPa (kgf/cm ² or bar, psi)	Rear wheel kPa (kgf/cm ² or bar, psi)
	160 km/h (99 mph) or less	240 (2.4, 35)	230 (2.3, 33)
	More than 160 km/h (99 mph)	270 (2.7, 40)	260 (2.6, 38)
▶ Diesel engine Tire inflation pressure (Recommended cold tire inflation pressure)	Vehicle speed	Front wheel kPa (kgf/cm ² or bar, psi)	Rear wheel kPa (kgf/cm ² or bar, psi)
	160 km/h (99 mph) or less	250 (2.5, 36)	230 (2.3, 33)
	More than 160 km/h (99 mph)	280 (2.8, 41)	260 (2.6, 38)
Tire inflation pressure (Compact spare) (Recommended cold tire inflation pressure)	420 kPa (4.2 kgf/cm ² or bar, 60 psi)		
Wheel size	16 × 6 1/2J, 17 × 4T (compact spare)		
Wheel nut torque	103 N·m (10.5 kgf·m, 76 ft·lbf)		

6-1. Specifications

► 17 inch tires

Tire size	215/55R17 94W, T145/70D17 106M (compact spare)		
► Gasoline engine Tire inflation pressure (Recommended cold tire inflation pressure)	Vehicle speed	Front wheel kPa (kgf/cm ² or bar, psi)	Rear wheel kPa (kgf/cm ² or bar, psi)
	190 km/h (118 mph) or less	240 (2.4, 35)	230 (2.3, 33)
	More than 190 km/h (118 mph)	270 (2.7, 40)	260 (2.6, 38)
► Diesel engine Tire inflation pressure (Recommended cold tire inflation pressure)	Vehicle speed	Front wheel kPa (kgf/cm ² or bar, psi)	Rear wheel kPa (kgf/cm ² or bar, psi)
	190 km/h (118 mph) or less	250 (2.5, 36)	230 (2.3, 33)
	More than 190 km/h (118 mph)	280 (2.8, 41)	260 (2.6, 38)
Tire inflation pressure (Compact spare) (Recommended cold tire inflation pressure)	420 kPa (4.2 kgf/cm ² or bar, 60 psi)		
Wheel size	17 × 7J, 17 × 4T (compact spare)		
Wheel nut torque	103 N·m (10.5 kgf·m, 76 ft·lbf)		

■ **When towing a trailer**

Add 20.0 kPa (0.2 kgf/cm² or bar, 3 psi) to the recommended tire inflation pressure, and drive at speeds below 100 km/h (62 mph).

■ **When installing a compact spare tire (vehicles with compact spare tire)**

Do not tow if your vehicle has a compact spare tire installed.

6-1. Specifications

Light bulbs

	Light Bulbs	W	Type
Exterior	Headlights		
	Low beam (Halogen bulbs)	55	A
	Low and high beam (Discharge bulbs)	35	B
	High beam (Halogen bulbs)	60	C
	Front fog lights	19	D
	Front position lights* (Halogen bulbs)	21/5	F
	Front position lights/daytime running lights* (Halogen bulbs)	21/5	F
	Front turn signal lights	21	E
	Rear turn signal lights	21	G
	Tail lights	5	H
	Back-up light	21	H
	Rear fog light	21	H
	License plate lights	5	F
Side turn signal lights	5	E	
Interior	Front personal/interior lights	5	F
	Rear personal/interior lights	8	F
	Vanity lights	8	F
	Door courtesy lights	5	F
	Luggage compartment light	5	I

*: If equipped

A: H11 halogen bulbs

B: D4S discharge bulbs

C: HB3 halogen bulbs

D: H16 halogen bulbs

E: Wedge base bulbs (amber)

F: Wedge base bulbs (clear)

G: Single end bulbs (amber)

H: Single end bulbs (clear)

I: Double end bulbs

6-1. Specifications

Fuel information

<p>▶ Gasoline engine</p>	<p>EU area: Your vehicle must use only unleaded gasoline conforming to European standard EN228. For optimum engine performance, select unleaded gasoline with a Research Octane Number of 95 or higher.</p> <p>Except EU area: Your vehicle must use only unleaded gasoline. For optimum engine performance, select unleaded gasoline with a Research Octane Number of 95 or higher.</p>
<p>▶ Diesel engine</p>	<p>Your vehicle must use only diesel fuel conforming to European standard EN590 which is an ultra low sulphur diesel (max 10 ppm).</p>

■ Fuel tank opening for unleaded gasoline (gasoline engine)

To help prevent incorrect fueling, your vehicle has a fuel tank opening that only accommodates the special nozzle on unleaded fuel pumps.

■ If you plan to drive in foreign countries (diesel engine)

Low sulphur diesel fuel may not be available, so please check the availability with your distributor.

■ If your engine knocks

- Consult any authorized Toyota dealer or repairer, or another duly qualified and equipped professional.
- You may occasionally notice light knocking for a short time while accelerating or driving uphill. This is normal and there is no need for concern.

 NOTICE

■ **Notice on fuel quality (gasoline engine)**

- Do not use improper fuels. If improper fuels are used, the engine will be damaged.
- Do not use leaded gasoline.
Leaded gasoline will cause the three-way catalytic converter to lose its effectiveness and the emission control system to function improperly.
- Do not use the methanol blended gasoline such as M15, M85, M100.
The use of gasoline containing methanol may cause engine damage or failure.
- EU area: Bioethanol fuel sold under names such as “E50” or “E85” and fuel containing a large amount of ethanol should not be used. The use of these fuels will damage the vehicle’s fuel system. In case of any doubt, ask any authorized Toyota dealer or repairer, or another duly qualified and equipped professional.
- Except EU area: Bioethanol fuel sold under names such as “E50” or “E85” and fuel containing a large amount of ethanol should not be used. Your vehicle can use gasoline mixed with 10% max ethanol. The use of fuel with more than 10% ethanol content (E10) will damage the vehicle’s fuel system. You must ensure that refueling is carried out only from a source where fuel specification and quality can be guaranteed. In case of any doubt, ask any authorized Toyota dealer or repairer, or another duly qualified and equipped professional.

 NOTICE**■ Notice on fuel quality (diesel engine)**

- Do not use improper fuels. If improper fuels are used, the engine will be damaged.
- EU area: FAME (Fatty Acid Methyl Ester) fuel sold under names such as “B30” or “B100” and fuel containing a large amount of FAME should not be used. The use of these fuels will damage the vehicle’s fuel system. In case of any doubt, ask any authorized Toyota dealer or repairer, or another duly qualified and equipped professional.
- Except EU area: FAME (Fatty Acid Methyl Ester) fuel sold under names such as “B30” or “B100” and fuel containing a large amount of FAME should not be used. Your vehicle can use diesel mixed with 5% max biodiesel FAME (B5). The use of fuel with more than 5% FAME content (B5) will damage the vehicle’s fuel system. You must ensure that refueling is carried out only from a source where fuel specification and quality can be guaranteed. In case of any doubt, ask any authorized Toyota dealer or repairer, or another duly qualified and equipped professional.

6-2. Customization

Customizable features

Your vehicle includes a variety of electronic features that can be personalized to your preferences. Programming these preferences requires specialized equipment and may be performed by any authorized Toyota dealer or repairer, or another duly qualified and equipped professional.

Some function settings are changed simultaneously with other functions being customized. Contact any authorized Toyota dealer or repairer, or another duly qualified and equipped professional.

Customizable Features

- 1** Vehicles with Navigation/Multimedia system: Settings that can be changed using the Navigation/Multimedia system
(For further information on customizing settings using the Navigation/Multimedia system, refer to the “Navigation and multimedia system Owner’s Manual”.)
- 2** Settings that can be changed by any authorized Toyota dealer or repairer, or another duly qualified and equipped professional for further details

Definition of symbols: O = Available, — = Not available

Item	Function	Default setting	Customized setting	1	2
Smart entry & start system (→P. 42)	Smart entry & start system	ON	OFF	O	O
	Open door warning function (when locking the vehicle)	ON	OFF	—	O

Item	Function	Default setting	Customized setting	1	2
Smart entry & start system (→P. 42)/ Wireless remote control (→P. 64)	Wireless remote control	ON	OFF	—	O
	Operation signal (Emergency flashers)	ON	OFF	—	O
	Time elapsed before automatic door lock function is activated if door is not opened after being unlocked	30 seconds	60 seconds 120 seconds	—	O
Door lock (→P. 73)	Shifting the shift lever to position other than “P” locks all doors*1	OFF	ON	O	O
	Shifting the shift lever to “P” unlocks all doors*1	OFF	ON	O	O
	Speed-detecting automatic door lock function	ON	OFF	O	O
	Opening driver’s door unlocks all doors	ON	OFF	—	O
Automatic light control system (→P. 244)	Light sensor sensitivity	Level 3	Level 1 to 5	O	O

6-2. Customization

Item	Function	Default setting	Customized setting	1	2
Illumination (→P. 358)	Time elapsed before lights turn off	15 seconds	7.5 seconds	—	O
			30 seconds		
	Operation after the engine switch (vehicles without smart entry & start system) or “ENGINE START STOP” switch (vehicles with smart entry & start system) turned off	ON	OFF	—	O
	Operation when the doors are unlocked	ON	OFF	—	O
	Operation when you approach the vehicle with the electronic key on your person*2 (When the interior light switch is in the door position)	ON	OFF	—	O
	Foot lights	ON	OFF	—	O
Lounge illumination	ON	OFF	—	O	
Lights (→P. 244)	Time that the low beam headlights are on when the vehicle is parked	30 seconds	60 seconds	—	O
			90 seconds		
			120 seconds		
Toyota parking assist-sensor (→P. 265)	Buzzer volume	3	1 to 5	—	O

*1: Vehicles with a Multidrive

*2: Vehicles with smart entry & start system

Multi-information display (→P. 232)

Available languages	English, French, German, Italian, Spanish, Russian, and Turkish
---------------------	---

6-3. Initialization

Items to initialize

The following item must be initialized for normal system operation in cases such as after the battery is reconnected, or maintenance is performed on the vehicle.

Item	When to initialize	Reference
Engine oil maintenance data*	After changing engine oil	P. 420
Tire pressure warning system (if equipped)	<ul style="list-style-type: none">• When rotating the tires on vehicles with differing front and rear tire inflation pressures• When changing tire pressure (such as when changing traveling speed)• When changing the tire size	P. 433

*: Diesel engine only

Index

Abbreviation list	608
Alphabetical index.....	609
What to do if... ..	620

Abbreviation list

Abbreviation/Acronym list

ABBREVIATIONS	MEANING
ABS	Anti-lock Brake System
CRS	Child Restraint System
DISP	Display
ECU	Electronic Control Unit
ELR	Emergency Locking Retractor
EPS	Electric Power Steering
GVM	Gross Vehicle Mass
LED	Light Emitting Diode
MPAC	Maximum Permissible Axle Capacity
SRS	Supplemental Restraint System
TRC	Traction Control
TWI	Treadwear Indicators
VIN	Vehicle Identification Number
VSC+	Vehicle Stability Control+

Alphabetical index

Alphabetical index

A	A/C	
	Air conditioning filter.....	450
	Automatic air conditioning system.....	310
	Manual air conditioning system.....	304
	ABS	280
	Active head restraint	84
	Air conditioning filter	450
	Air conditioning system	
	Air conditioning filter.....	450
	Automatic air conditioning system.....	310
	Manual air conditioning system.....	304
	Airbags	
	Airbag manual on-off system.....	178
	Airbag operating conditions.....	149
	Airbag precautions for your child.....	153
	Airbag warning light.....	501
	Curtain shield airbag operating conditions.....	149
	Curtain shield airbag precautions.....	153
	General airbag precautions.....	153
	Locations of airbags.....	147
	Modification and disposal of airbags.....	157
	Proper driving posture.....	145, 153
	Side airbag operating conditions.....	149
	Side airbag precautions.....	153
	SRS airbags.....	147
	Alarm	136
	Antenna	326
	Anti-lock brake system	280
	Armrests	378
	Assist grips	382
	Audio input	354
	Audio system	
	Antenna.....	326
	Audio input.....	338, 345, 354
	AUX port.....	354
	CD player.....	327
	iPod.....	338
	MP3/WMA disc.....	332
	Optimal use.....	352
	Portable music player.....	354
	Radio.....	323
	Steering wheel audio switch.....	355
	Type.....	321
	USB memory.....	345

Automatic air conditioning system	
Air conditioning filter.....	450
Automatic air conditioning system.....	310
Automatic headlight leveling system.....	249
Automatic light control system.....	244
AUX port.....	354
Auxiliary boxes.....	369, 386
B	
Back-up light	
Replacing light bulb.....	472
Wattage.....	598
Back door	
Back door.....	79
Battery	
Checking.....	425
If the vehicle has discharged battery.....	565
Preparing and checking before winter.....	289
Bottle holders.....	368
Brake	
Parking brake.....	219
Brake assist.....	280
Break-in tips.....	187
Brightness control	
Instrument cluster light control.....	226

C	
Care	
Exterior.....	396
Interior.....	400
Seat belts.....	401
Cargo capacity.....	286
Cargo hooks.....	385
CD player.....	327
Chains.....	289
Child-protectors.....	75
Child restraint system	
Baby seats, definition.....	158
Baby seats, installation.....	166
Child seats, definition.....	158
Child seats, installation.....	166
Installing CRS with ISOFIX rigid anchor.....	172
Installing CRS with seat belts.....	167
Installing CRS with top straps.....	173
Junior seats, definition.....	158
Junior seats, installation.....	166

Child safety
 Airbag precautions 153
 Battery precautions 427, 567
 Child-protectors 75
 Child restraint system 158
 How your child should wear
 the seat belt 100
 Installing child restraints 166
 Panoramic roof shade
 precautions 117
 Power window lock switch 112
 Power window precautions ... 115
 Removed key battery
 precautions 456
 Seat belt precautions 101
 Seat heater
 precautions 377
Cleaning
 Exterior 396
 Interior 400
 Seat belts 401
Clock 238
Condenser 424
Console box 364
Cooling system
 Engine overheating 569
Cruise control 258
Cup holders 366
Curtain shield airbags 147
Customizable features 602

D **Daytime running light system** 247
Deck board 385
Defogger
 Rear window 319
 Side mirrors 319
Dimension 578
Display
 Multi-information display 232
 Trip information 233
 Warning message 509
Do-it-yourself maintenance 406
Door courtesy lights
 Door courtesy lights 358
 Wattage 598
Doors
 Back door 79
 Door glasses 112
 Door lock 42, 64, 73
 Double locking system 134
 Rear door child protector 75
 Side doors 73
 Side mirrors 109
Double locking system 134
Driver's and front passenger's seat belt reminder light 503
Driving
 Break-in tips 187
 Correct posture 145
 Procedures 184
 Winter driving tips 289

E

Electronic key

If your electronic does not
operate properly 562

Electronic power steering 280

Emergency flashers

Switch 490

Emergency tire puncture

repair kit 539

Emergency, in case of

If the electronic key does not
operate properly 562

If the engine will not start 556

If the shift lever cannot be
shifted from "P" 559

If the vehicle has discharged
battery..... 565

If the warning buzzer
sounds 500

If the warning light
turns on..... 500

If the warning message is
displayed 509

If you cannot operate back
door opener 561

If you have a flat tire 522, 539

If you lose your keys 560

If you think something is
wrong..... 498

If your vehicle becomes
stuck 572

If your vehicle has to be
stopped in an emergency ... 574

If your vehicle needs to be
towed 491

If your vehicle overheats 569

Engine

Accessory mode 204

Compartment 414

Engine switch..... 198, 202

Hood 410

How to start the
engine..... 198, 202

Identification number 580

If the engine will not start 556

Ignition switch 198, 202

Overheating 569

Engine compartment cover 416

Engine coolant

Capacity 590

Checking..... 422

Preparing and checking
before winter..... 289

Engine coolant temperature

indicator (Blue)..... 229

Engine coolant temperature

warning light (Red)..... 500

Engine immobilizer system 124

Engine oil

Capacity 584

Checking..... 417

Preparing and checking
before winter..... 289

Engine oil maintenance

data..... 420

Engine switch 198, 202

EPS 280

F	Floor mat	383
	Fluid	
	Washer.....	429
	Fog lights	
	Replacing light bulbs.....	472
	Switch	251
	Wattage.....	598
	Foot lights	358
	Front fog lights	
	Replacing light bulbs.....	472
	Switch	251
	Wattage.....	598
	Front position lights	
	Replacing light bulbs.....	472
	Switch	244
	Wattage.....	598
	Front seats	
	Adjustment	84
	Front turn signal lights	
	Replacing light bulbs.....	472
	Switch	218
	Wattage.....	598
	Fuel	
	Capacity	583
	Fuel gauge	222
	Fuel pump shut off system....	499
	Gas station information	624
	Information	599
	Refueling.....	119
	Type	583
	Fuel door	119
	Fuel filler door	119
	Fuel filter	430
	Fuel pump shut off system	499
	Fuses	457

G	Gas station information	624
	Gauges	222
	Glove box	363
	Glove box light	363
H	Hazard lights	
	Switch	490
	Head restraints	
	Adjusting	94
	Headlight cleaners	255
	Headlights	
	Discharged headlights	
	precautions.....	488
	Replacing light bulbs.....	472
	Switch	244
	Wattage	598
	Heaters	
	Seat heaters	376
	Side mirror	319
	Hill-start assist control	280
	Hood	410
	Hooks	
	Cargo hooks	385
	Horn	221
I	Identification	
	Engine.....	581
	Vehicle.....	580
	Ignition	
	Engine switch.....	198, 202
	Ignition switch	198, 202
	Keys.....	38
	Ignition switch	198, 202
	Illuminated entry system	361
	Immobilizer system	124

Indicator lights 227

Initialization

- Items to initialize 606
- Tire pressure warning system 432

Inside rear view mirror 105

Instrument cluster light control 226

Intercooler 424

Interior lights

- Interior lights 359, 360
- Switch 359, 360
- Wattage 598

Intrusion sensor 138

J

Jack

- Positioning a floor jack 412
- Replacing the wheel 522
- Vehicle-equipped jack 522, 539

Jack handle 522, 539

K

Keyless entry 42, 64

Keys

- Electronic key 38
- Engine switch 198, 202
- If the electronic key does not operate properly 562
- If you lose your keys 560
- Ignition switch 198, 202
- Key number plate 38
- Keyless entry 42, 64
- Keys 38
- Mechanical key 38
- Wireless remote control key 64

Knee airbag 147

L

License plate lights

- Replacing light bulbs 472
- Switch 244
- Wattage 598

Light bulbs

- Replacing 472
- Wattage 598

Lights

- Door courtesy lights 358
- Emergency flasher switch 490
- Fog light switch 251
- Foot lights 358
- Front door courtesy lights 358
- Hazard light switch 490
- Headlight switch 244
- Luggage compartment light 80
- Personal/interior light switch 359, 360
- Replacing light bulbs 472
- Turn signal lever 218
- Vanity lights 372
- Wattage 598

Luggage compartment

- Auxiliary boxes 386
- Cargo hooks 385
- Luggage cover 387

Luggage cover 387

M	Maintenance	
	Do-it-yourself	
	maintenance	406
	Maintenance data	578
	Maintenance	
	requirements.....	403
	Manual air conditioning	
	system	304
	Manual headlight leveling	
	dial	245
	Manual transmission	
	Gear Shift Indicator.....	215
	Manual transmission	214
	Meter	
	Instrument cluster light	
	control.....	226
	Meters	222
	Mirrors	
	Inside rear view mirror	105
	Side mirror heater	319
	Side mirrors.....	109
	Vanity mirrors.....	372
	MP3 disc	332
	Multi-information	
	display	232
	Multidrive	
	7-speed sport sequential	
	shiftmatic mode	211
	If the shift lever cannot be	
	shifted from "P"	559
	Multidrive.....	208
O	Odometer	222
	Oil	
	Engine oil	417
	Opener	
	Fuel filler door	119
	Hood	410

	Outside rear view mirrors	
	Adjusting and folding	109
	Outside temperature	
	display	233
	Overhead console	366
	Overheating, Engine	569
P	Panoramic roof shade	116
	Parking brake	219
	Personal/interior lights	
	Switch	359, 360
	Wattage	598
	Power heater	317
	Power outlets	374
	Power windows	112
R	Radiator	424
	Radio	323
	Rear fog light	
	Replacing light bulb	472
	Switch	251
	Wattage	598
	Rear seats	
	Adjustment.....	86
	Folding the seats	89
	Rear side sunshades	381
	Rear turn signal lights	
	Replacing light bulbs.....	472
	Switch	218
	Wattage	598
	Rear window defogger	319
	Rear window wiper and	
	washer	257
	Replacing	
	Fuses	457
	Key battery.....	453
	Light bulbs	472
	Tires.....	522
	Roof luggage carrier	286

S	Seat belts		Shift lever	
	Adjusting the seat belt.....	96	If the shift lever cannot	
	Child restraint system		be shifted from "P".....	559
	installation.....	166	Manual transmission.....	214
	Cleaning and maintaining		Multidrive	208
	the seat belts	401	Shift lock system	559
	Emergency Locking		Side airbags	147
	Retractor.....	100	Side mirrors	
	How to wear your seat belt	96	Adjusting and folding	109
	How your child should wear		Side turn signal lights	
	the seat belt.....	100	Switch	218
	Pregnant women, proper seat		Wattage	598
	belt use	101	Smart entry & start system	
	Rear passenger's seat belt		Antenna location	44
	reminder light.....	231, 503	Entry function.....	42
	Reminder light.....	503	Starting the engine.....	202
	Seat belt pretensioners	100	Spare tire	
	Seat heaters	376	Inflation pressure	595
	Seatback tables.....	379	Storage location.....	522
	Seats		Spark plug	591
	Adjustment	84, 86	Specifications	578
	Adjustment precautions	85, 93	Speed limiter	262
	Child seats/child restraint		Speedometer.....	222
	system installation	166	Steering wheel	
	Cleaning.....	400	Adjustment.....	104
	Front seats adjustment	84	Audio switches.....	355
	Head restraints.....	94	Column lock release	200, 205
	Properly sitting in the seat....	145	Stop & Start cancel switch	274
	Rear seats adjustment.....	86	Stop & Start system	273
	Seat heaters.....	376	Storage features	362
	Service reminder			
	indicators	227		

Storage precautions	287	T	Tachometer	222
Stuck			Tail lights	
If your vehicle becomes			Replacing light bulbs.....	472
stuck	572		Switch	244
Sun visors	371		Wattage	598
Sunshades			Theft deterrent system	
Panoramic roof.....	116		Alarm	136
Rear side.....	381		Double locking system.....	134
Switch			Engine immobilizer system ..	124
Airbag manual on/off.....	178		Intrusion sensor	138
Emergency flasher switch	490		Tire inflation pressure	445
Engine switch.....	198, 202		Tire pressure warning	
Fog light switch	251		system	432
Hazard light switch.....	490		Function	432
Ignition switch	198, 202		Initializing	433
Light switches	244		Installing tire pressure	
Power door lock switch	73		warning valves and	
Power window switches	112		transmitters.....	432
Rear window wiper and			Registering ID codes	435
washer switch	257		Tire pressure warning	
"SPORT" mode switch	209		reset switch	433
Stop & Start cancel switch	274		Warning light.....	503
Tire pressure warning			Tires	
reset switch.....	433		Chains.....	291
Window lock switch.....	112		Checking.....	431
Wipers and washer			Emergency tire puncture	
switch.....	252, 257		repair kit.....	539
			If you have a flat	
			tire	522, 539
			Inflation pressure	445
			Replacing.....	522
			Rotating tires.....	431
			Size.....	595
			Snow tires	289
			Spare tire	522
			Tire pressure warning	
			system	432

Tools 522, 539

Towing

- Emergency towing 493
- Trailer towing 293

Toyota parking assist-sensor 265

Traction control 280

Trailer towing 293

Transmission shift switches... 208

TRC 280

Trip information display 233

Trip meter 222

Turn signal lights

- Replacing light bulbs 472
- Switch 218
- Wattage 598

V

Vanity lights

- Vanity lights 372
- Wattage 598

Vanity mirrors 372

Vehicle identification number 580

Vehicle stability control + 280

VSC+ 280

W

Warning buzzers

- Brake system 500
- Electric power steering system buzzer 501
- Open door 512
- Seat belt reminder 503

Warning lights

- Anti-lock brake system 501
- Automatic headlight leveling system 501
- Brake assist system 501
- Brake system 500
- Charging system 500
- Cruise control 501
- Electric power steering system warning light 501
- Engine coolant temperature 500
- Low fuel level 503
- Malfunction indicator lamp ... 501
- Master warning light 503
- Pretensioner 501
- Seat belt reminder light 503
- Slip indicator light 501
- SRS airbags 501
- Stop & Start cancel indicator light 501
- Tire pressure warning light ... 503

Warning messages

Back door..... 512
 Clutch start system 510
 Cruise control..... 510
 DPF catalytic converter..... 512
 Engine oil level..... 512
 Engine oil maintenance..... 512
 Engine oil pressure 509
 Fuel filter 510
 Light reminder 512
 Open door..... 512
 Parking brake..... 512
 Smart entry & start system... 516
 Speed limiter system..... 510
 Steering lock system..... 510
 Transmission fluid
 temperature 512

Washer

Checking 429
 Preparing and checking
 before winter..... 289
 Switch 252, 257

Washing and waxing 396

Weight..... 578

Wheels 447

Window glasses..... 112

Window lock switch..... 112

Windows

Power windows..... 112
 Rear window defogger..... 319
 Washer 252, 257

Windshield wipers 252

Wireless remote control key

Replacing the battery..... 453
 Wireless remote control 64

WMA disc 332



What to do if... What to do if...

A tire punctures	P. 522, 539	If you have a flat tire
The engine does not start	P. 556	If the engine will not start
	P. 124	Engine immobilizer system
	P. 565	If the vehicle battery is discharged
The shift lever cannot be moved out	P. 559	If the shift lever cannot be shifted from "P"
The high engine coolant temperature warning light (Red) flashes or comes on	P. 569	If your vehicle overheats
Steam can be seen coming from under the hood		
The key is lost	P. 560	If you lose your keys
The battery runs out	P. 565	If the vehicle battery is discharged
The doors cannot be locked	P. 73	Side doors
	P. 79	Back door
The horn begins to sound	P. 136	Alarm
The vehicle is stuck in mud or sand	P. 572	If the vehicle becomes stuck

The warning light or indicator light comes on

P. 500 If a warning light turns on

■ **Instrument cluster**

▶ **Left-hand drive vehicles**

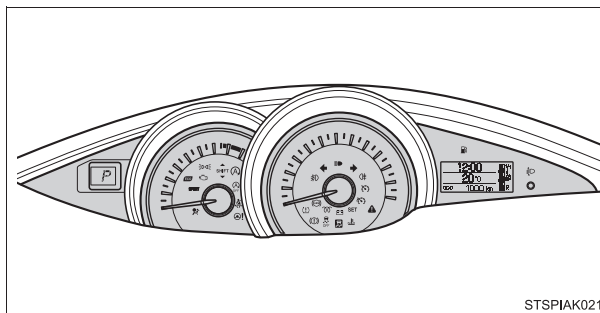

STSPIAK021

▶ **Right-hand drive vehicles**

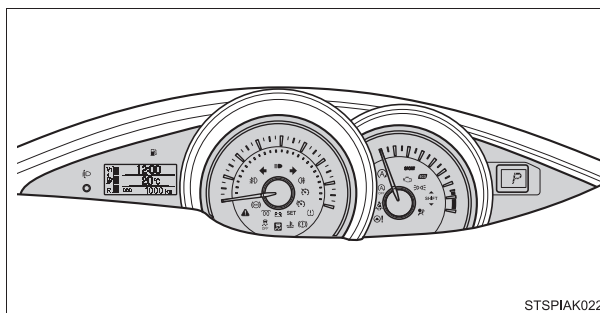

STSPIAK022



What to do if...

■ **Center panel**



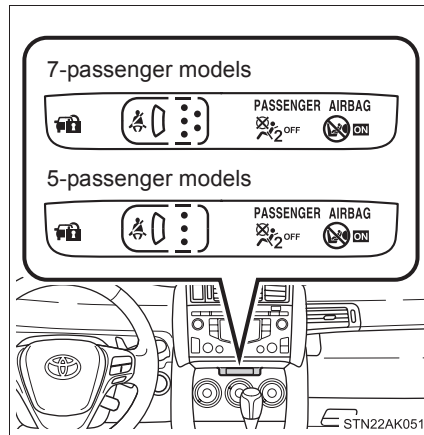



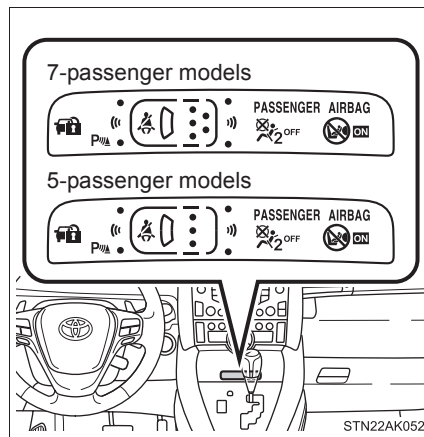









▶ Vehicles with manual air conditioning system



▶ Vehicles with automatic air conditioning system



■ Warning lights

	Brake system warning light P. 500		Slip indicator light* ² P. 501
	Charging system warning light P. 500		Automatic headlight leveling system warning light P. 502
	High engine coolant temperature warning light P. 500		Low fuel level warning light P. 503
(Red)			Master warning light P. 503
	Malfunction indicator lamp P. 501		Tire pressure warning light P. 504
	SRS warning light P. 501		Driver's and front passenger's seat belt reminder light P. 504
	ABS warning light P. 501		Rear passenger's seat belt reminder light P. 504
	Electric power steering system warning light P. 501	or	
	Cruise control warning light* ¹ P. 501		P. 504
	Stop & Start cancel indicator light* ¹ P. 501		

*1: The light flashes to indicate a malfunction.

*2: The light comes on to indicate a malfunction.

The warning message is displayed

P. 509 If a warning message is displayed

GAS STATION INFORMATION

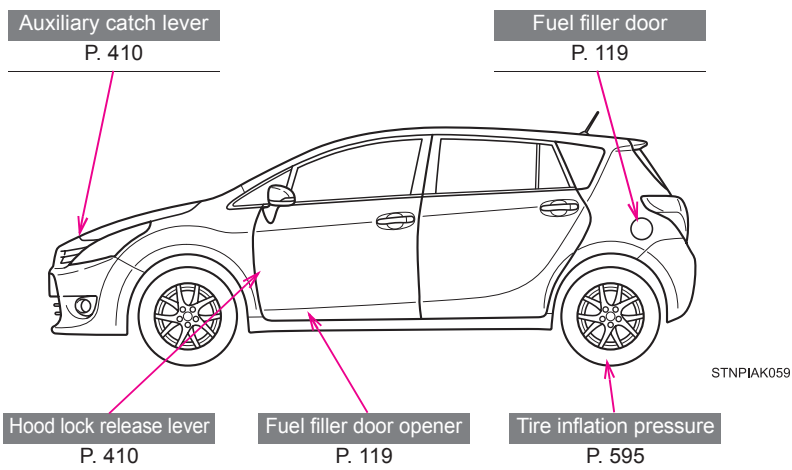

Fuel tank capacity (reference)	Gasoline engine: 60 L (15.9 gal., 13.2 Imp.gal.) Diesel engine: 55 L (14.5 gal., 12.1 Imp.gal.)
Fuel type	P. 121, 583
Cold tire inflation pressure	P. 595
Engine oil capacity (drain and refill - reference)	P. 584
Engine oil type	P. 584